



**Xtra  
seal**<sup>®</sup>

**PROFESSIONAL TIRE REPAIR  
TPMS & SUPPLIES**



Makers of



[www.31inc.com](http://www.31inc.com)



[www.tpmsnetwork.com](http://www.tpmsnetwork.com)



[www.smartsensorupdate.com](http://www.smartsensorupdate.com)

### U.S. Plant and International Headquarters

100 Enterprise Drive  
Newcomerstown, Ohio 43832 U.S.A.

Phone (740) 498-8324 | 800-438-3302  
Fax (740) 498-8325  
email: [info@31inc.com](mailto:info@31inc.com)  
[www.31inc.com](http://www.31inc.com)

31 Incorporated was founded in 1961 by Bob Cornell, a former employee of Tech International. In 1985 Bob Hendry and Chuck Muhs joined the company to run sales and operations. In 1987 Bob and Chuck acquired the company from Mr. Cornell when he was ready to retire from the business. From humble beginnings, 31 Inc. has grown to become well-known internationally as a leading manufacturer of professional tire repair, TPMS, and supplies. Primary manufacturing is still operated in rural Newcomerstown, OH USA, as well as a secondary manufacturing operation in China, Zhejiang, Shangyu city.

## OUR CORE VALUES

### WE MANUFACTURE TIRE REPAIR MATERIALS AS IF IT IS DESTINED FOR OUR OWN FAMILY VEHICLE

31 Inc., having a quality management system certified to ISO 9001:2008 with design, is dedicated to manufacturing high-quality tire repair materials and supplies. From the raw material stage to finished product, production is monitored and examined to ensure we meet or exceed rigorous quality standards. We also utilize third party standards and testing companies to qualify the products we make.

### WORLD CLASS CUSTOMER SERVICE WITH A PERSONAL TOUCH

There is no phone answering system at 31 Inc. Your call is always answered with a friendly voice on the other end. We take personal ownership and pride in being available to assist our customers all around the world.

### TRAINING AND EDUCATION IS PARAMOUNT TO OUR SALES PROGRAM

31 Inc. is committed to training and educating our customers and industry personnel on the proper application of our tire repair materials, TPMS, and supplies in accordance with industry standard procedures. We not only conduct on-site hands-on training, but also make available detailed repair videos, web support, and other forms of training resources.

### HUMBLE SERVANT FOR THE INDUSTRY

The folks at 31 Inc. are happy to help all those with stake in our industry. We actively participate in the Tire Industry Association and Tread Rubber and Repair Materials Group (TIA & TRMG).

**31 Inc. – At Your Service!**

<b>PUNCTURE REPAIR PASSENGER / LIGHT DUTY TRUCK</b>	4
Professional Tire Repair Systems	4
Combination Repair Units	6
Vulcanizing Stems	7
Universal Repair Units	8
Passenger Radial Repair Units	9

## TUBE REPAIR UNITS 10

<b>HEAVY-DUTY PROFESSIONAL TIRE REPAIR</b>	11
Heavy-Duty Repair Systems	11
HD Combination Repair Units	12
HD Radial Repair Units	13
Vulcanizing Stems	14
HD Agricultural Radial Repair Units	16
HD Agricultural Bias-Ply Repair Units	17
HD Agricultural Combination Units	18
Giant OTR Repair Units	20
Section Repair Material & Equipment	21
Lincoln Vulcanizing Equipment	23
Regroovers & Heat Knives	24
Regroover Replacement Parts & Accessories	25

<b>XTRASEAL CHEMICAL SOLUTIONS</b>	26
Tire Repair Chemicals	26
Appearance Chemicals	27
Mounting/Demounting Compounds & Accessories	28

<b>PUNCTURE REPAIR INSERTS</b>	30
Universal String-Type Inserts & Kits	33
Emergency Repair Kits	34

<b>TIRE &amp; WHEEL SERVICE</b>	36
Miscellaneous Tire Repair Tools	36
Tire Injury Probes	40
Tire Repair Tools	41
Pneumatics & Accessories	42
Rasps & Cups	45
Wheel Service Tools	46
Socket & Wheel Service Kits	47
Tire Repair Tool Organizers	51
Tire Mount/Demount Tools	52
Mounting Rings & Accessories	55
Wheel Service	57
Counteract	58
Lift Pads	59

Tire Changing Accessories	60
Stud Cleaning Tools	63
Lug Nuts & Spline Adapters	64

<b>TPMS</b>	66
Smart Sensor Pro+	66
Technical Application Data	67
TPMS Parts Kits Assortments	68
TPMS Replacement Parts Kits & Valve Stems	69
TPMS Service Kits	70
TPMS Valve Kits	71
TPMS Service Tools	72
TPMS Accessories	73

<b>VALVE HARDWARE</b>	74
Passenger & Light Truck Valves	74
Heavy Truck Valves	76
Agricultural & Misc. Valve Hardware	79
Haltec Large Bore Solutions	80
Valve Tools & Accessories	81

<b>AIRTOOLS, HOSES &amp; ACCESSORIES</b>	84
Air Chucks	84
Air Gauges	86
Air Hoses & Accessories	88
Couplers & Plugs	90

<b>XTRASEAL RETAIL</b>	96
Merchandisers	98
Tire Repair	99
Tire Gauges	102
Air Accessories	105
TPMS Tools & Accessories	111
Valve Hardware	112
Couplers & Plugs	116

<b>APPENDIX</b>	
Product Information	124
Tire Repair Limitations	125
Puncture Repair Procedures	126
Glossary of Tire Repair Terms	130
Glossary of TPMS Terms	134
TPMS Service Procedure	136
Repair Systems Content Listings	137
Spinner Contents Example	140
INDEX	141

## PROFESSIONAL TIRE REPAIR SYSTEMS

31 Inc. offers **complete startup systems** for passenger and light truck tire puncture repair. Each system includes the recommended mix of tire repair materials, chemicals, and tools for the job. Precise step-by-step, industry approved guidelines are included as well in each of these manageable and well organized systems.

**31 Inc. helps take the guesswork out of your tire service program.**

See Page 137 for Complete Contents Listing of Tire Repair Systems

### Safe & Effective

It's easy with XtraSeal tire repair systems.

#### 14-603 Tire Service Set with Wall Cabinet

- Deluxe wall-mount cabinet
- Loaded to complete over 110 industry standard puncture repairs
- All the tools plus XLIGHT, air powered vacuum, carbide cutters, and more
- Preloaded 1-box shipping unit

#### 14-604 Wall Cabinet Assortment

- Deluxe wall-mount cabinet
- Loaded to complete over 130 industry standard puncture repairs
- All the tools including a reversible drill, XLIGHT, air powered vacuum, carbide cutters, and more



14-603  
Shown Here

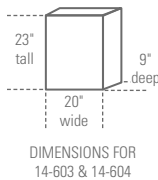

#### 14-613 Rolling Cabinet Assortment

- Loaded to complete over 110 industry standard puncture repairs
- All the tools including an air powered vacuum, carbide cutters and more
- Heavy duty service cart
- 500 lb. load capacity
- Extending lid with automatic gas shocks
- Ball bearing cabinet glides
- 40" tall  
39" wide  
22" deep





**14-652  
Tire Repair Materials Toolbox**

- Tire repair materials and chemicals for industry standard puncture repair
- Organized in a large rugged toolbox
- Includes puncture repair procedures guide and poster



**14-651  
Quilled Unit  
Puncture Repair  
Toolbox**

- Complete set designed to utilize the popular quilled unit series of 1-piece repair
- Includes the tire repair materials, chemicals, tools and procedures
- Organized in a large rugged toolbox



*See Page 137 for  
Complete Contents Listing of  
Tire Repair Systems*

**14-653  
Lead-Wire Puncture Repair  
Toolbox**

- Complete set includes all the materials, chemicals and tools for industry standard puncture repair
- Also includes buffer, air powered vacuum, carbide cutters, and XLIGHT
- Organized in a large rugged toolbox
- Includes puncture repair procedures guide and poster



## COMBINATION REPAIR UNITS

**Combination repair units** fulfill the industry recommended repair requirements of “filling the injury” and “patching the innerliner” for a one-piece repair system. Use when the injury angle is less than 25 degrees. Refer to page 125 for repair limitations and follow the installation procedures on page 126.

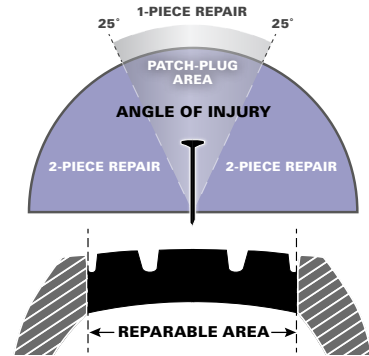

### Lead-Wire Combination Units

- For use in radial and bias ply tires
- Designed for chemical or heat vulcanization
- Patch portion has gray vulcanizing gum with blue poly backing
- Stem portion is dip coated or wrapped with premium vulcanizing gum

LEAD-WIRE COMBINATION UNITS – DIPPED STEM					
Part Number	Description	Injury Size	Box Qty	Case Qty	Carbide
13-670	1" (27mm)	1/8" (3mm)	20	12	14-340
13-672	1 5/8" (42mm)	3/16" (4.5mm)	24	10	14-345
13-673	2 1/8" (55mm)	1/4" (6mm)	24	10	14-346
13-674	2 1/8" (55mm)	5/16" (8mm)	24	10	14-347
13-675	2 1/8" (55mm)	3/8" (10mm)	16	10	14-348

LEAD-WIRE COMBINATION UNITS – WRAPPED STEM					
Part Number	Description	Injury Size	Box Qty	Case Qty	Carbide
13-672C	1 5/8" (42mm)	3/16" (4.5mm)	24	10	14-345
13-673C	2 1/8" (55mm)	1/4" (6mm)	24	10	14-346
13-674C	2 1/8" (55mm)	5/16" (8mm)	24	10	14-347
13-675C	2 1/8" (55mm)	3/8" (10mm)	16	10	14-348

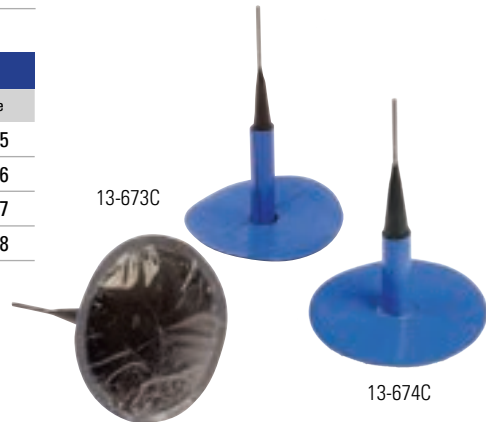

### Gray Gum Lead-Wire Combination Units

- Specially formulated gray gum coating over the stem

LEAD-WIRE COMBINATION UNITS - GRAY GUM					
Part Number	Description	Injury Soze	Box Qty	Case Qty	Carbide
13-672G	1 5/8" (42mm)	3/16" (4.5mm)	24	10	14-345
13-673G	2 1/8" (55mm)	1/4" (6mm)	24	10	14-346
13-674G	2 1/8" (55mm)	5/16" (8mm)	24	10	14-347
13-675G	2 1/8" (55mm)	3/8" (10mm)	16	10	14-348

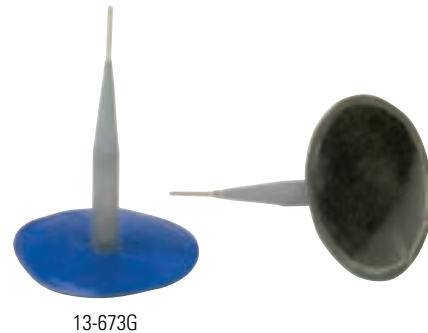

## Universal Quilled Combination Units

- For use in radial and bias ply tires
- Designed for chemical vulcanization
- Black vulcanizing gum, white backing
- Equipped with quick-release metal quill for easy installation

UNIVERSAL QUILLED COMBINATION UNITS				
Part Number	Description	Injury Size	Box Qty	Case Qty
<b>13-381</b>	1 5/8" (42mm) Round	1/8" (3mm)	20	10
<b>13-383</b>	1 7/8" (47mm) Round	3/16" (4.5mm)	20	10
<b>13-382</b>	2 1/4" (57mm) Round	1/4" (6mm)	15	10
<b>13-381SQ</b>	1 5/8" (40mm) Square	1/8" (3mm)	20	10
<b>13-382SQ</b>	2 1/4" (57mm) Square	1/4" (6mm)	15	10

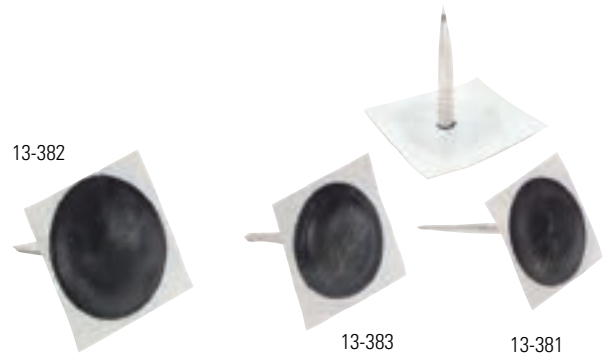

Also available in boxes of 100.  
Use part number 13-381-100, etc.

## Radial Quilled Combination Units

- For use in the tread area of radial tires
- Designed for chemical vulcanization
- Black vulcanizing gum, white backing
- Equipped with metal quill for easy installation

RADIAL QUILLED COMBINATION UNITS				
Part Number	Description	Injury Size	Box Qty	Case Qty
<b>13-375</b>	1 5/8" x 2 7/8" (42 x 73mm)	1/4" (6mm)	15	10
<b>13-376</b>	2 1/4" x 4" (57 x 100mm)	5/16" (8mm)	10	10
<b>13-377</b>	2 5/8" x 5 3/8" (67 x 137mm)	3/8" (10mm)	5	10



## VULCANIZING STEMS

**Vulcanizing stems** fulfill the industry recommended repair requirements of "filling the injury" when used as part of a two-piece repair system. The lead-wire conveniently guides the stem through installation and seals the injury. Refer to page 125 for repair limitations and follow the installation procedures on page 126.

### Lead-Wire Inserts

- For use in radial and bias ply tires
- Dipped or wrapped with vulcanizing gum
- Designed for chemical or heat vulcanization

LEAD-WIRE INSERTS - DIPPED STEM					
New Part Number	Old Part Number	Injury Size	Box Qty	Case Qty	Carbide
<b>12-412</b>	<b>13-621</b>	3/16" (4.5mm)	20	10	14-345
<b>12-413</b>	<b>13-620</b>	1/4" (6mm)	20	10	14-346
<b>12-414</b>	<b>13-622</b>	5/16" (8mm)	20	10	14-347
<b>12-415</b>	<b>13-623</b>	3/8" (10mm)	20	10	14-348

LEAD WIRE INSERTS - WRAPPED					
New Part Number	Old Part Number	Injury Size	Box Qty	Case Qty	Carbide
<b>12-412C</b>	<b>13-621C</b>	3/16" (4.5mm)	20	10	14-345
<b>12-413C</b>	<b>13-620C</b>	1/4" (6mm)	20	10	14-346
<b>12-414C</b>	<b>13-622C</b>	5/16" (8mm)	20	10	14-347
<b>12-415C</b>	<b>13-623C</b>	3/8" (10mm)	20	10	14-348

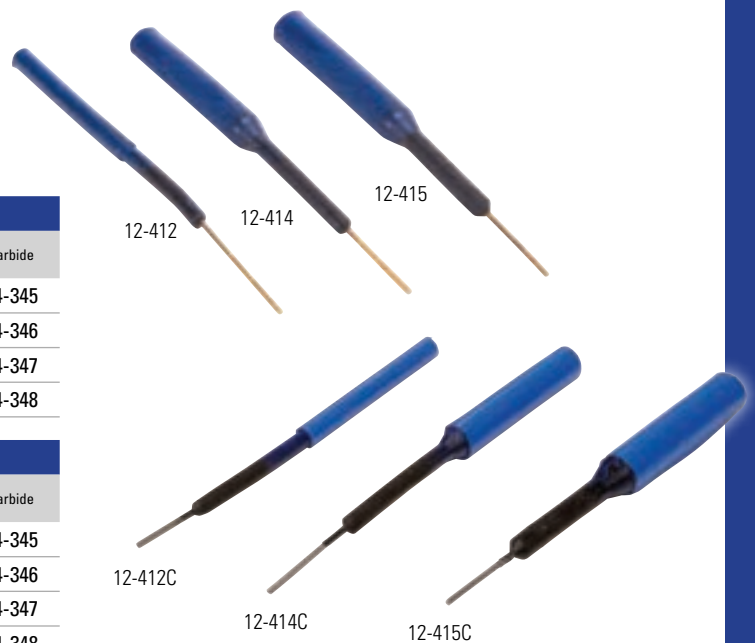



## UNIVERSAL REPAIR UNITS

**Universal repair units** follow industry recommended repair requirements for “patching the innerliner” as part of a two-piece repair system. These repair units are rubber reinforced and ideal for puncture repair in tubeless radial and bias ply tires. Refer to page 125 for repair limitations and follow the installation procedures on page 126.

### USA-Style Universal Repair Units

- Our most popular universal repair designed for chemical vulcanization
- Black vulcanizing gum, blue poly backing

USA-STYLE UNIVERSAL REPAIR UNITS					
Part Number	Description	Size (inches)	Size (mm)	Box Qty	Case Qty
11-306	Small Square	1 3/4	45	50	12
11-308	Medium Square	2 1/8	55	25	24
11-310	Large Square	3	75	15	24
11-321	Small Round	1 5/8	41	30	24
11-321 SB	Small Bucket			300	–
11-321 LB	Large Bucket			700	–
11-322	Medium Round	2 1/4	57	25	24
11-322 SB	Small Bucket			200	–
11-322 LB	Large Bucket			500	–
11-323	Large Round	3 1/4	82	15	24
11-324	Small Oval	1 3/8 x 2 3/8	37 x 61	25	12
11-325	Medium Oval	1 7/8 x 3 7/8	48 x 98	15	12
11-326	Xtra Large Round	4 1/4	110	10	12



### Euro-Style Universal Repair Units

- Extra thick yet flexible, heavy-duty nail hole repair
- Designed for chemical or heat vulcanization
- Premium blue vulcanizing gum, white backing

EURO-STYLE UNIVERSAL REPAIR UNITS					
Part Number	Description	Size (inches)	Size (mm)	Box Qty	Case Qty
11-307	Mini Square	1 1/2	38	50	12
11-309	Small Square	1 7/8	48	50	12
11-309 SB	Small Bucket			150	–
11-309 LB	Large Bucket			350	–
11-311	Medium Square	2 1/4	57	50	12
11-311 SB	Small Bucket			75	–
11-311 LB	Large Bucket			200	–
11-312	Large Square	2 1/2	66	50	12
11-313	Small Oval	1 3/4 x 3	45 x 75	10	10

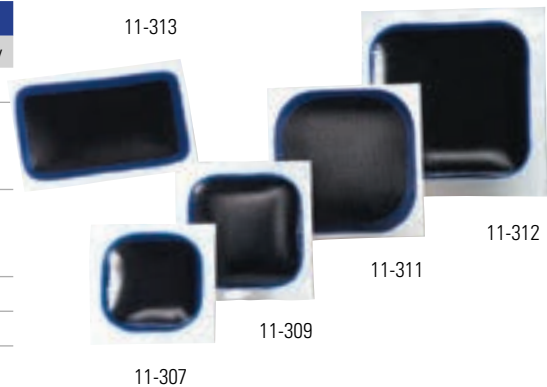

### Square Universal Repair Units

- Designed for chemical vulcanization
- Gray vulcanizing gum, red or blue poly backing

SQUARE UNIVERSAL REPAIR UNITS					
Part Number	Description	Size (inches)	Size (mm)	Box Qty	Case Qty
11-115	Small, Red Poly	1 7/8	47	30	24
11-115 SB	Small Bucket			300	–
11-115B	Small, Blue Poly	1 7/8	47	30	24
11-116	Medium, Red Poly	2 1/8	54	30	24
11-116 SB	Small Bucket			200	–
11-116B	Medium, Blue Poly	2 1/8	54	30	24

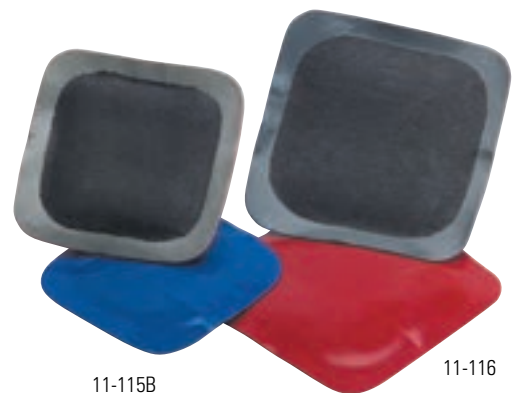



## PASSENGER RADIAL REPAIR UNITS

These **radial repairs** are a highly-effective reinforced repair units for passenger and light truck radial tires. Refer to page 125 for repair limitations and follow the installation procedures on page 126.

### Passenger and Light Truck Radial Puncture Repairs

- Designed for chemical or heat vulcanization
- Flocking cord for strong, flexible repair
- Black vulcanizing gum, white backing



PASSENGER AND LIGHT TRUCK RADIAL PUNCTURE REPAIRS					
Part Number	Description	Size (inches)	Size (mm)	Box Qty	Case Qty
11-413	Small Oval	1 5/8 x 2 7/8	41 x 73	10	10
11-414	Medium Oval	2 1/8 x 3 7/8	55 x 98	10	10
11-415	Large Oval	2 5/8 x 5 3/8	67 x 137	10	10

### USA-Style Radial Repair Units

- Each reinforcing ply is individually end-wrapped to deflect tire flexing stresses in a unique manner
- Tie-gum construction eliminates the potential for delamination common in competitive products
- Designed to vulcanize chemically or in low temperature systems
- Gray vulcanizing gum, blue poly backing

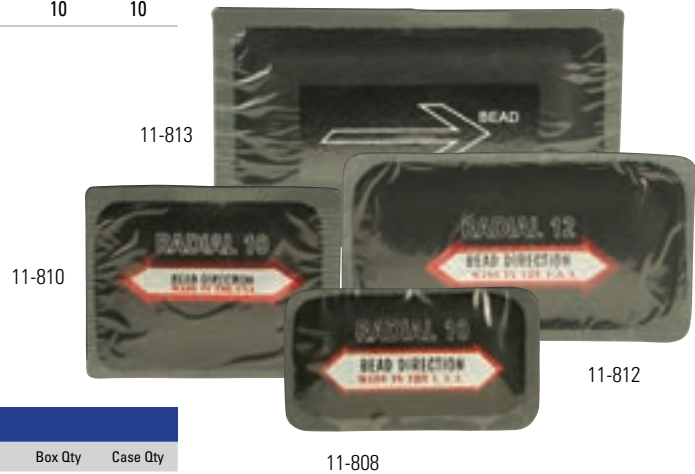

USA-STYLE RADIAL REPAIR UNITS					
Part Number	Description	Size (inches)	Size (mm)	Box Qty	Case Qty
11-808	Radial 10, 1 Ply	1 5/8 x 3	42 x 75	20	10
11-810	Radial 10, 1 Ply	2 3/8 x 3	60 x 75	20	10
11-812	Radial 12, 1 Ply	2 1/4 x 4	57 x 100	10	10
11-813	Radial 12, 1 Ply	2 3/4 x 4 1/2	70 x 114	10	10

### Euro-Style Radial Repair Units

- Each reinforcing ply is specifically end-cut and wrapped to "float" inside the patch to prevent end cracking or breakout common in competitive products
- Designed to vulcanize chemically, in low temperature, or high heat curing systems
- Premium blue vulcanizing gum, white backing

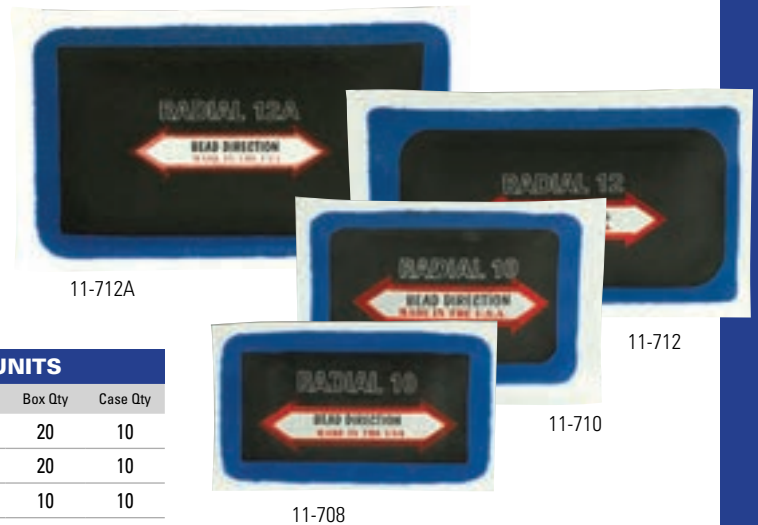

EURO-STYLE PASSENGER RADIAL REPAIR UNITS					
Part Number	Description	Size (inches)	Size (mm)	Box Qty	Case Qty
11-708	Radial 10, 1 Ply	1 3/4 x 2 7/8	45 x 73	20	10
11-710	Radial 10, 1 Ply	2 x 3	50 x 75	20	10
11-712	Radial 12, 1 Ply	2 1/4 x 4	57 x 102	10	10
11-712A	Radial 12, 1 Ply	2 3/4 x 4 5/8	70 x 118	10	10



These **tube repair units**, designed principally for use on inner tubes, are twice as strong as the tube being repaired and have a feather-edge design to prevent chaffing. When repairing inner tubes, buttonhole the ends of the injury and select a repair unit at least twice as large as the injury being repaired.

**FEATHER-EDGE TUBE REPAIR UNITS**

Part Number	Description	Size (inches)	Size (mm)	Box Qty	Case Qty
11-000	Mini Round	1 1/4	32	100	12
11-001	Small Round	1 3/4	41	40	24
11-002	Medium Round	2 1/4	57	30	24
11-003	Large Round	3 1/4	82	20	12
11-007	Giant Round	5	125	10	6
11-004	Small Oval	1 3/8 x 2 3/8	35 x 60	30	12
11-005	Medium Oval	1 3/4 x 3 3/4	45 x 97	20	12
11-006	Large Oval	2 1/2 x 5 5/8	65 x 144	20	12
11-008	Giant Oval	3 3/4 x 6 1/8	95 x 155	10	6

**FOIL-BACK TUBE REPAIR UNITS**

Part Number	Description	Size (inches)	Size (mm)	Box Qty	Case Qty
11-032	Mini Round	1	26	80	12
11-038	X-tra Small Round	1 3/8	35	70	12
11-045	Small Round	1 5/8	42	50	12
11-055	Medium Round	2	52	40	12
11-079	Large Round	3	77	20	12

**EURO-STYLE TUBE REPAIR UNITS**

Part Number	Description	Size (inches)	Size (mm)	Box Qty	Case Qty
11-632	Mini Round	1 1/4	30	100	12
11-638	X-tra Small Round	1 3/8	35	50	12
11-645	Small Round	1 5/8	42	40	12
11-655	Medium Round	2	52	30	12
11-679	Large Round	3	77	20	12
11-690	X-tra Large Round	3 1/2	90	10	12
11-6115	Giant Round	4 1/2	114	10	12
11-672	Mini Oval	1 1/8 x 1 5/8	28 x 42	50	12
11-673	X-tra Small Oval	1 1/2 x 2 1/2	38 x 64	50	12
11-674	Small Oval	1 7/8 x 2 7/8	48 x 72	40	12
11-675	Medium Oval	2 1/8 x 4 1/2	55 x 115	30	12
11-676	Large Oval	2 3/8 x 5 3/4	60 x 145	20	12

**BICYCLE REPAIR KITS**

Part Number	Description	Case Qty
13-201	Bicycle Tube Repair Kit In Dispenser Contains: 3 - 1" x 1" patch, 8 sq. in. of rubber, 1 cement tube, 1 thumb buffer - 12 kits/sleeve	12
13-208	Bicycle Tube Repair Kit In Canister Contains: 30 sq. in. of rubber, 8 - 1" x 1" patches, 1 cement tube, 1 thumb buffer	12
13-209	Bicycle Tube Repair Kit Contains: 10 - mini patches, 1 cement tube, 1 thumb buffer	-

**Feather-Edge Tube Repair Units**

- Designed for chemical vulcanization
- Black vulcanizing gum, white poly backing
- Gray vulcanizing gum with blue poly also available. Use part number 11-001BG, 11-002BG, etc.



**Foil-Back Tube Repair Units**

- Designed for chemical or heat vulcanization
- Black vulcanizing gum, foil-like backing

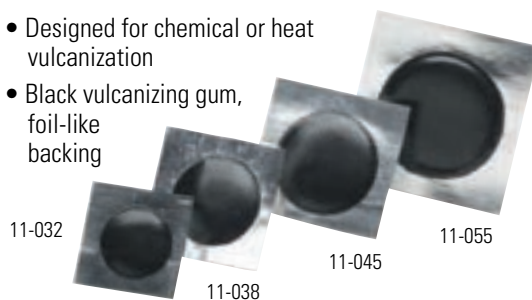

**Euro-Style Tube Repair Units**

- Designed for chemical or heat vulcanization
- Premium blue vulcanizing gum, white backing

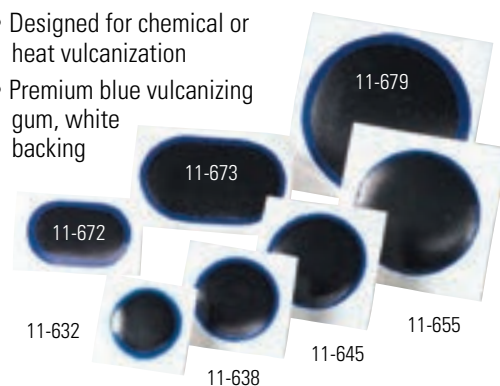

## HEAVY-DUTY TIRE REPAIR SYSTEMS

31 Inc. offers complete startup systems for **heavy-duty truck tire puncture repair**.

Each system includes the recommended mix of tire repair materials, chemicals, and tools for the job. Precise step-by-step, industry approved guidelines are included as well in each of these manageable and well organized systems.

See Page 137 for  
Complete Contents Listing of  
Tire Repair Systems

**31 Inc. helps take the guesswork out of your tire service program.**

**Safe & Effective**  
**It's easy with XtraSeal**  
**tire repair systems.**

### 14-605 Heavy-Duty Truck Tire Service Set with Wall Cabinet

- Deluxe wall-mount cabinet
- Loaded to complete over 130 industry standard puncture repairs
- All the tools + reversible drill, XLIGHT, air powered vacuum, carbide cutters, and more



### 14-657 Heavy-Duty Toolbox Kit

- Complete set includes all the materials, chemicals and tools for industry standard puncture repair
- Also includes reversible drill, air powered vacuum, carbide cutters, and XLIGHT
- Organized in a large rugged toolbox
- Includes puncture repair procedures guide and poster



### 14-650 Truck Tire Nail Hole Repair Kit

- Our original puncture repair kit for truck tires
- Includes both two-piece and one-piece repair units, tools, and instructions
- Ready for radial and bias-ply tire repair
- Heavy-duty toolbox





## HEAVY-DUTY COMBINATION REPAIR UNITS

**Combination repair units** fulfill the industry recommended repair requirements of “filling the injury” and “patching the innerliner” for a one-piece repair system. Use when the injury angle is less than 25 degrees. Refer to page 125 for repair limitations and follow the installation procedures on page 126.

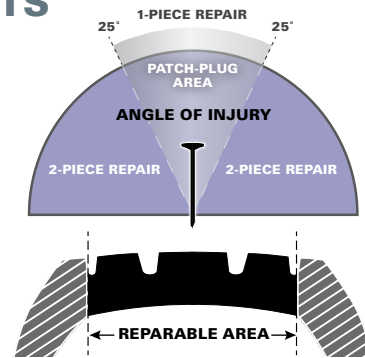

### Lead-Wire Combination Units

- For use in radial and bias ply tires
- Designed for chemical or heat vulcanization
- Patch portion has gray vulcanizing gum with blue poly backing
- Stem portion is dip coated or wrapped with premium vulcanizing gum

LEAD-WIRE COMBINATION UNITS - DIPPED STEM					
Part Number	Description	Injury Size	Box Qty	Case Qty	Carbide
13-672	1 5/8" (42mm)	3/16" (4.5mm)	24	10	14-345
13-673	2 1/8" (55mm)	1/4" (6mm)	24	10	14-346
13-674	2 1/8" (55mm)	5/16" (8mm)	24	10	14-347
13-675	2 1/8" (55mm)	3/8" (10mm)	16	10	14-348

LEAD-WIRE COMBINATION UNITS - WRAPPED STEM					
Part Number	Description	Injury Size	Box Qty	Case Qty	Carbide
13-672C	1 5/8" (42mm) Round	3/16" (4.5mm)	24	10	14-345
13-673C	2 1/8" (55mm) Round	1/4" (6mm)	24	10	14-346
13-674C	2 1/8" (55mm) Round	5/16" (8mm)	24	10	14-347
13-675C	2 1/8" (55mm) Round	3/8" (10mm)	16	10	14-348
13-774C	3 1/2" (88mm) Square	3/8" (10mm)	5	6	14-348
13-775C	4" (100mm) Square	1/2" (12.5mm)	5	6	14-349

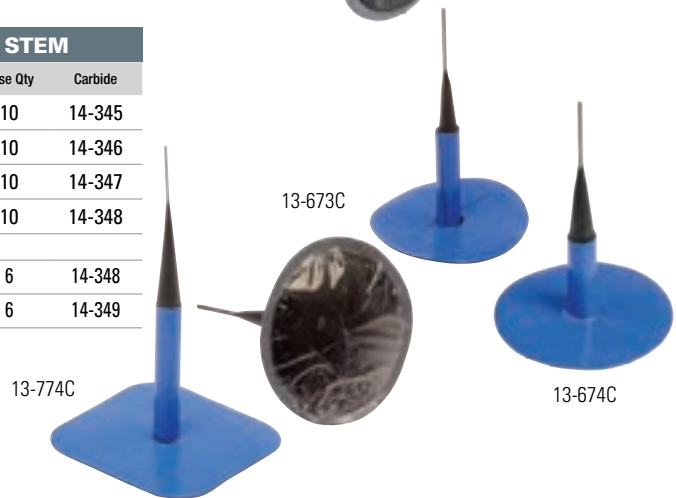
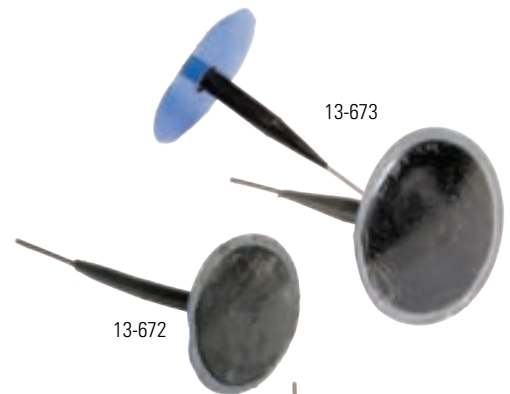

### Gray Gum Lead-Wire Combination Units

- Specially formulated gray gum coating over the stem

LEAD-WIRE COMBINATION UNITS - GRAY GUM					
Part Number	Description	Injury Size	Box Qty	Case Qty	Carbide
13-672G	1 5/8" (42mm)	3/16" (4.5mm)	24	10	14-345
13-673G	2 1/8" (55mm)	1/4" (6mm)	24	10	14-346
13-674G	2 1/8" (55mm)	5/16" (8mm)	24	10	14-347
13-675G	2 1/8" (55mm)	3/8" (10mm)	16	10	14-348

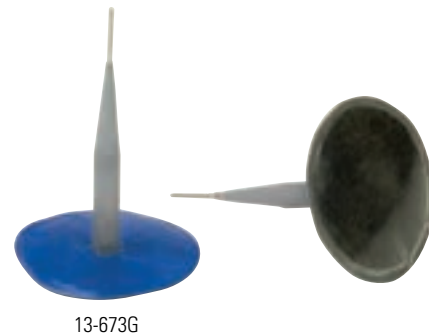



## HEAVY-DUTY RADIAL REPAIR UNITS

**Heavy-Duty Radial Repairs** are designed for use in puncture, reinforcement, and section repairs in any repairable area of a passenger, truck, agricultural, or earthmover radial tire. Radial Repairs are extremely strong yet very flexible.



### Euro-Style Radial Repair Units

- Each reinforcing ply is specifically end-cut and wrapped to "float" inside the patch to prevent end cracking or breakout common in competitive products
- Designed to vulcanize chemically, in low temperature, or high heat curing systems
- Premium blue vulcanizing gum, white backing

EURO-STYLE HEAVY-DUTY RADIAL REPAIR UNITS							
Part Number	Description	Size (inches)	Size (mm)	Box Qty	Case Qty	AR Series	U Series
11-708	Radial 10, 1 Ply	1 3/4 x 2 7/8	45 x 73	20	10	11-AR708	—
11-710	Radial 10, 1 Ply	2 x 3	50 x 75	20	10	11-AR710	—
11-712	Radial 12, 1 Ply	2 1/4 x 4	57 x 102	10	10	11-AR712	—
11-712A	Radial 12, 1 Ply	2 3/4 x 4 5/8	70 x 118	10	10	11-AR712A	—
11-714	Radial 14, 1 Ply	3 3/8 x 4	87 x 100	10	10	11-AR714	—
11-720	Radial 20, 2 Ply	2 3/4 x 5	70 x 125	10	6	11-AR720	—
11-722	Radial 22, 2 Ply	3 x 6	76 x 150	10	6	11-AR722	—
11-724	Radial 24, 2 Ply	2 7/8 x 8 1/2	73 x 215	10	6	11-AR724	11-724U
11-725	Radial 25, 3 Ply	4 1/2 x 5	115 x 125	10	1	11-AR725	—
11-726	Radial 26, 3 Ply	3 x 10 3/8	75 x 265	10	1	11-AR726	11-726U
11-728	Radial 28, 3 Ply	3 x 12 3/4	76 x 325	10	1	11-AR728	11-728U
11-735	Radial 35, 3 Ply	5 x 7 1/8	128 x 181	10	1	11-AR735	11-735U
11-740	Radial 40, 3 Ply	3 7/8 x 7 3/8	98 x 187	10	6	11-AR740	11-740U
11-742	Radial 42, 4 Ply	4 7/8 x 9 7/8	123 x 250	10	1	11-AR742	11-742U
11-744	Radial 44, 4 Ply	4 3/4 x 13	121 x 330	10	1	11-AR744	11-744U
11-745	Radial 45, 4 Ply	7 1/2 x 9	191 x 230	5	1	11-AR745	11-745U

**AR Series:**  
These repair units are reinforced with **Aramid Cord**.

- Stronger than steel (pound for pound)
- Safer and easier to install than steel
- Easier to use in low profile tires
- Lightweight – No balancing distortion
- Reduces sidewall bulging

**U Series:**  
These repair units are uncured for use in heat curing systems only.



### NOTE

*Injury MUST be within repairable limits. Refer to page 125 for repair limitations.*

## USA-Style Radial Repair Units

- Each reinforcing ply is individually end-wrapped to deflect tire flexing stresses in a unique manner
- Tie-gum construction eliminates the potential for delamination common in competitive products
- Designed to vulcanize chemically or in low temperature systems
- Gray vulcanizing gum, blue poly backing



USA-STYLE HEAVY-DUTY RADIAL REPAIR UNITS					
Part Number	Description	Size (inches)	Size (mm)	Box Qty	Case Qty
11-808	Radial 10, 1 Ply	1 5/8 x 3	42 x 75	20	10
11-810	Radial 10, 1 Ply	2 3/8 x 3	60 x 75	20	10
11-812	Radial 12, 1 Ply	2 1/4 x 4	57 x 100	10	10
11-813	Radial 12, 1 Ply	2 3/4 x 4	70 x 100	10	10
11-814	Radial 14, 1 Ply	3 3/4 x 4	95 x 100	10	10
11-820	Radial 20, 2 Ply	2 7/8 x 5	72 x 125	10	6
11-822	Radial 22, 2 Ply	3 x 6	75 x 150	10	6
11-824	Radial 24, 2 Ply	3 x 8 1/2	75 x 215	10	6
11-825	Radial 25, 3 Ply	4 1/2 x 5	115 x 125	10	1
11-826	Radial 26, 3 Ply	3 x 11	76 x 278	10	1
11-828	Radial 28, 3 Ply	3 x 14	76 x 355	10	1
11-835	Radial 35, 3 Ply	5 1/4 x 7	133 x 180	10	1
11-840	Radial 40, 3 Ply	4 x 7 3/8	100 x 188	10	6
11-842	Radial 42, 4 Ply	5 x 10	125 x 254	10	1
11-844	Radial 44, 4 Ply	5 x 13	125 x 330	10	1
11-845	Radial 45, 4 Ply	7 1/2 x 9 1/2	190 x 240	5	1

### R SERIES:

(Part numbers 11-824R, 11-826R, 11-840R, etc.)

These repair units are designed to be used in high heat (mold cure) systems.

#### \* Curing Information for R Series

##### Heat Chamber:

240°F (116°C) for 72 min., 270°F - 320°F (132°C - 160°C) for 30 min.

##### Spotter:

270°F - 320°F (132°C - 160°C), 10 min. per 1/8" (3mm)

### A SERIES:

(Part numbers 11-824A, 11-826A, 11-840A, etc.)

These repair units have no face gum (ply package only) on black Holland cloth.

## VULCANIZING STEMS

**Vulcanizing stems** fulfill the industry recommended repair requirements of "filling the injury" when used as part of a two-piece repair system. The lead-wire conveniently guides the stem through installation and seals the injury. Refer to page 125 for repair limitations and follow the installation procedures on page 126.

### Lead-Wire Inserts

- For use in radial and bias ply tires
- Dipped or Wrapped with vulcanizing gum
- Designed for chemical or heat vulcanization



LEAD-WIRE INSERTS - DIPPED STEM					
New Part Number	Old Part Number	Injury Size	Box Qty	Case Qty	Carbide
12-412	13-621	3/16" (4.5mm)	20	10	14-345
12-413	13-620	1/4" (6mm)	20	10	14-346
12-414	13-622	5/16" (8mm)	20	10	14-347
12-415	13-623	3/8" (10mm)	20	10	14-348

LEAD WIRE INSERTS - WRAPPED					
New Part Number	Old Part Number	Injury Size	Box Qty	Case Qty	Carbide
12-412C	13-621C	3/16" (4.5mm)	20	10	14-345
12-413C	13-620C	1/4" (6mm)	20	10	14-346
12-414C	13-622C	5/16" (8mm)	20	10	14-347
12-415C	13-623C	3/8" (10mm)	20	10	14-348

**COI RADIAL APPLICATION CHART**

SIDEWALL INJURY		TREAD INJURY	PASSENGER	LIGHT TRUCK	HEAVY TRUCK		EARTHMOVER	
 L= Length of injury W=Width of injury		 D= Diameter of injury						
Maximum Width	Maximum Length	Maximum Diameter	Speed Ratings U, V, W, X, Y and Z		6.50 - 12.50	7.50 - 10.00	11.00 - 14.00	14.00 - 40.00
			125 - 195	205 - 255	215/85 - 255/85 215/75 - 285/60	8 - 11 235/80 - 275/80 225/75 - 295/75	12 - 16.5 295/80 - 315/80 305/75-495/45	15.5 - 50.5 20/65 - 65/65
1/8"(3mm)	1/8" (3mm)	1/8" (3mm)	10	10	10	10	10	42
		1/4" (6mm)	10	10	10	12	12	42
1/4"(6mm)	1/4" (6mm) 5/16" (8mm)	1/4" (6mm)			12	12	12	42
							22	22
1 cable	1 1/2" (40mm) 3 1/8" (80mm) 4 3/4" (120mm) 6" (150mm)	1/4" (6mm)			20	22	22	
					22	22	22	
						24	24	
						26	26	
2 cables	3/4" (19mm) 1 1/2" (40mm) 2 3/8" (60mm) 5 1/8" (130mm)	1/4" (6mm)			20	22	22	
					20	22	24	
					22	24	26	
						26	28	
3/8" (10mm)	1 1/2" (40mm) 2 3/8" (60mm) 3 1/8" (80mm) 5 1/8" (130mm)	3/8" (10mm)			20	20	20	42
					20	26	40	44
					22	26	40	
					26	40	42	
					42	44	44	
1/2" (12mm)	1 1/2" (40mm) 2 3/4" (70mm) 3 3/4" (95mm) 5 1/8" (130mm)	1/2" (12mm)			22	25	25	44
					22	40	40	44
					22	40	42	
					40	42	42	
3/4" (19mm)	1" (25mm) 2 1/2" (65mm) 4 3/8" (110mm) 5 1/8" (130mm)	3/4" (19mm)			22	25	*35/40	44
					22	40	40	44
					24	42	42	
						42	44	
		44	44					
1" (25mm)	1" (25mm) 2" (50mm) 3 1/8" (80mm) 4" (100mm)	1" (25mm)			25	*35/42	*35/42	44
					40	42	44	
						42	44	
						44	44	
1 1/4" (30mm)	2" (50mm) 3 1/8" (80mm) 4" (100mm)	1 1/4" (30mm)				*35/42	*35/42	
						42	44	
						44	44	

**SHOULDER INJURY**



1/4" (6mm)			22		24	24	42
3/8" (10mm)					24	40	
1/2" (12mm)			24		24		44
3/4" (19mm)			24		40	40	
1" (25mm)			40		44	44	

\*35 are for crown (tread) only repairs.

# HEAVY-DUTY AGRICULTURAL RADIAL REPAIR UNITS

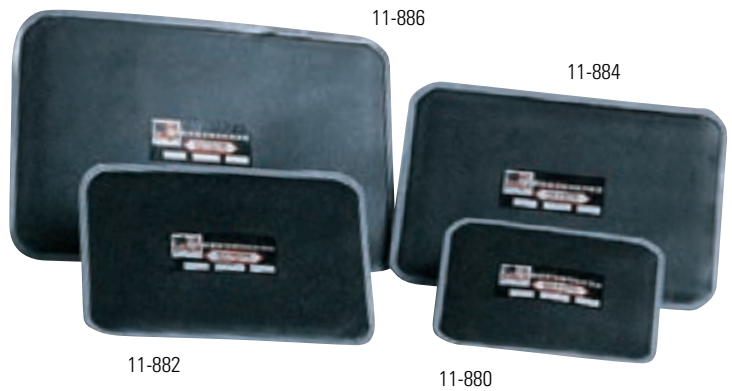

## Euro-Style Radial Agricultural Repair Units

- Each reinforcing ply is specifically end-cut and wrapped to "float" inside the patch to prevent end cracking or breakout common in competitive products
- Designed to vulcanize chemically, in low temperature, or high heat curing systems
- Premium blue vulcanizing gum, white backing

## USA-Style Radial Agricultural Repair Units

- Each reinforcing ply is individually end-wrapped to deflect tire flexing stresses in a unique manner
- Tie-gum construction eliminates the potential for delamination common in competitive products
- Designed to vulcanize chemically or in low temperature systems
- Gray vulcanizing gum, blue poly backing

EURO-STYLE RADIAL AGRICULTURAL REPAIR UNITS					
Part Number	Description	Size (inches)	Size (mm)	Box Qty	Case Qty
11-780	Radial 80, 2 Ply	5 7/8 x 7 3/4	150 x 197	5	1
11-782	Radial 82, 3 Ply	7 3/8 x 10	188 x 254	5	1
11-784	Radial 84, 3 Ply	8 3/8 x 11 3/8	213 x 290	5	1
11-786	Radial 86, 3 Ply	9 5/8 x 13 3/8	245 x 340	5	1

USA-STYLE RADIAL AGRICULTURAL REPAIR UNITS					
Part Number	Description	Size (inches)	Size (mm)	Box Qty	Case Qty
11-880	Radial 80, 2 Ply	5 7/8 x 7 3/4	150 x 197	5	1
11-882	Radial 82, 3 Ply	7 1/2 x 10	190 x 254	5	1
11-884	Radial 84, 3 Ply	8 1/2 x 11 1/2	216 x 292	5	1
11-886	Radial 86, 3 Ply	9 3/4 x 13 3/8	248 x 340	5	1

RADIAL AGRICULTURAL APPLICATION CHART				
SIDEWALL INJURY		TREAD INJURY	AGRICULTURAL	
Maximum Width	Maximum Length	Maximum Diameter	8 - 11	12 - 15
1/4" (6mm)	1/4" (6mm)		8.3 - 12.4	13.6 - 30.5
3/8" (10mm)	3/8" (10mm)	3/8" (10mm)	12	12
	1 1/2" (40mm)			
3/4" (19mm)	3/4" (19mm)	3/4" (19mm)	20	20
	3" (75mm)		22	80
1 1/2" (40mm)	4" (100mm)	1 1/2" (40mm)	80	82
2" (50mm)	3 1/4" (80mm)			
	3" (75mm)			
2 1/2" (65mm)	4" (100mm)			
	2 3/4" (70mm)	2 3/4" (70mm)	80	
3 1/4" (80mm)	3 1/4" (80mm)		80	82
	5 1/4" (130mm)			
3 1/2" (90mm)	4 1/2" (115mm)	3 1/2" (90mm)		
	4" (100mm)	4" (100mm)		
4" (100mm)	6 1/2" (165mm)			
	5 1/4" (130mm)	5 1/4" (130mm)		86

### USING THIS CHART

- 1) Measure the injury being repaired across the largest area of broken or removed cord. If injury is in the sidewall, measure width (across the cords) and length (along the cords). If injury is in the tread or shoulder area, measure the diameter of the injury.
- 2) Locate these measurements under the appropriate injury column. If actual injury size is between measurements on the chart, go up to the next largest measurement.
- 3) When you locate the correct injury size on the chart, go to the appropriate tire size column. Where the injury size row and the tire size column intersect is the correct COI Radial repair unit to use.



### REPAIRtips

When installing repair units in agricultural tires that will contain calcium, coat the entire repair unit with 14-128A Inner Liner Sealer after installation.



# HEAVY-DUTY AGRICULTURAL BIAS-PLY REPAIR UNITS

**Bias-ply repair units** are designed for use in nailhole, reinforcing, or section repairs and can be applied in any repairable area of a tube or tubeless bias ply tire.

CP CROSS-PLY-BIAS AGRICULTURAL					
Part Number	Description	Size (inches)	Size (mm)	Box Qty	Case Qty
11-386	CP0, 1 Ply	2 1/8	55	20	12
11-387	CP1, 1 Ply	3	77	10	12
11-388	CP2, 2 Ply	3 5/8	92	10	12
11-453	CP3, 2 Ply	4 3/8	112	10	10
11-454	CP4, 4 Ply	5 1/2	140	10	10
11-455	CP5, 4 Ply	6 3/4	172	10	10
11-456	CP6, 6 Ply	9 5/8	250	5	6
11-457	CP7, 6 Ply	11 3/8	290	5	6
11-458	CP8, 6 Ply	13 3/8	341	5	6
11-459	CP9, 8 Ply	15	380	3	6
11-4510	CP10, 8 Ply	16 1/4	415	3	1

CPT CROSS-PLY-BIAS AGRICULTURAL					
Part Number	Description	Size (inches)	Size (mm)	Box Qty	Case Qty
11-460	CPT0, 4 Ply	8 1/8	207	10	6
11-461	CPT1, 4 Ply	9 1/4	234	5	6
11-462	CPT2, 4 Ply	11 5/8	295	5	6
11-463	CPT3, 4 Ply	15	380	5	1
11-464	CPT4, 6 Ply	9 1/4	235	5	6
11-465	CPT5, 6 Ply	11 5/8	295	5	6
11-466	CPT6, 6 Ply	15	381	5	1
11-467	CPT7, 6 Ply	19 1/2	495	3	1

*CP repair units are also available for high heat (mold cure) systems. Request part number 11-453R, 11-454R, 11-455R, etc.*

*CPT repair units are also available for high heat (mold cure) systems. Request part number 11-460R, 11-461R, 11-462R, etc.*

BN BIAS-PLY AGRICULTURAL					
Part Number	Description	Size (inches)	Size (mm)	Box Qty	Case Qty
11-488	BN1, 1 Ply	2 1/8	55	30	12
11-489	BN2, 2 Ply	3	75	20	12
11-490	BN3, 2 Ply	3 1/2	89	20	10
11-491	BN4, 2 Ply	4 1/4	110	10	10
11-492	BN5, 2 Ply	5 1/4	135	10	10
11-493	BN7, 3 Ply	6 1/2	165	10	10
11-494	BN8, 3 Ply	7 1/2	190	10	10
11-495	BN9, 4 Ply	8 5/8	220	10	5
11-496	BN10, 6 Ply	9 7/8	250	5	5
11-497	BN12, 6 Ply	12	305	5	5
11-498	BN15, 8 Ply	15	380	3	6
11-499	BN20, 8 Ply	20	508	3	1

BNT BIAS-PLY AGRICULTURAL					
Part Number	Description	Size (inches)	Size (mm)	Box Qty	Case Qty
11-480	BNT20, 4 Ply	9 7/8	250	10	5
11-481	BNT21, 4 Ply	14 1/2	370	5	6
11-482	BNT22, 4 Ply	20	508	3	1
11-483	BNT23, 6 Ply	9 7/8	250	10	5
11-484	BNT24, 6 Ply	14 1/2	370	5	6
11-485	BNT25, 6 Ply	20	508	3	1

## CP Cross-Ply-Bias / CPT Cross-Ply-Bias Agricultural

- Each reinforcing ply is protected and encased in a molded ply package making each unit strong while remaining flexible
- Designed to vulcanize chemically or in low temperature systems
- Gray vulcanizing gum, blue poly backing



## BN Bias-Ply / BNT Bias-Ply Agricultural

- Each reinforcing ply is protected and encased in a molded-ply package making each unit strong while remaining flexible
- Fine feather edge eliminates chaffing
- Designed to vulcanize chemically, in low temperature, or high heat curing systems
- Premium blue vulcanizing gum, white backing



### AG Bias Ply

- Designed primarily for use in agricultural bias ply tube or tubeless tires
- Designed for chemical vulcanization
- Black vulcanizing gum, blue poly backing

AG BIAS PLY REPAIR UNITS					
Part Number	Description	Size (inches)	Size (mm)	Box Qty	Case Qty
11-470	AG3, 2 Ply	3 1/2	90	20	10
11-471	AG4, 2 Ply	4 1/2	115	10	10
11-472	AG5, 2 Ply	5 1/2	140	10	10
11-473	AG6, 3 Ply	6 1/2	165	10	10
11-474	AG7, 4 Ply	7 1/2	190	10	10
11-475	AG8, 4 Ply	8 1/2	215	10	5
11-476	AG10, 6 Ply	10 1/2	265	5	5
11-477	AG12, 6 Ply	12 1/2	317	5	5
11-478	AG15, 8 Ply	15 1/2	394	1	1
11-479	AG18, 8 Ply	18 1/2	470	1	1



### Chop Cord Emergency Boots

- Designed primarily for use in agricultural tires
- Flocking cord reinforced for a strong yet flexible repair
- Designed for chemical vulcanization
- Black vulcanizing gum, white poly backing

CHOP CORD EMERGENCY BOOTS				
Part Number	Description	Size (inches)	Size (mm)	Box Qty
11-503	Round Boot	3	76	50
11-507	Round Boot	4 1/2	115	50
11-509	Oval Boot	4 x 5	100 x 130	25
11-511	Oval Boot	5 1/2 x 8	140 x 203	25
11-513	Oval Boot	7 x 10	180 x 255	25
11-515	Oval Boot	9 x 12	230 x 305	10
11-517	Oval Boot	10 x 14	255 x 350	10



## HEAVY-DUTY AGRICULTURAL COMBINATION REPAIR UNITS

### Agricultural Combination Units

- For use in radial and bias ply agricultural and OTR tires (low pressure, slow speed)
- Designed for chemical or heat vulcanization
- Patch portion has gray vulcanizing gum with blue poly backing



AGRICULTURAL COMBINATION UNITS				
Part Number	Patch Size	Stem Diameter	Carbide Cutter	Box Qty
13-788	4" (100mm)	5/8" (15mm)	14-349	5



BIAS PLY REPAIR APPLICATION CHART																	
Ply Rating	INJURY SIZE																
	3mm 1/8"	6mm 1/4"	10mm 3/8"	15mm 1/2"	20mm 3/4"	25mm 1"	40mm 1 1/2"	50mm 2"	65mm 2 1/2"	75mm 3"	100mm 4"	125mm 5"	150mm 6"	175mm 7"	200mm 8"	225mm 9"	250mm 10"
<b>PASSENGER, TRUCK &amp; EARTHMOVER</b>																	
4	CP0	CP0	CP1	CP2	CP3	CP3	CP4	CP5	CP6								
	BN1	BN1	BN2	BN3	BN4	BN4	BN4	BN7	BN9								
6	CP0	CP0	CP1	CP2	CP3	CP3	CP4	CP5	CP6								
	BN1	BN2	BN3	BN4	BN5	BN5	BN8	BN9	BN10								
8	CP0	CP0	CP2	CP3	CP3	CP4	CP4	CP5	CP6								
	BN1	BN2	BN3	BN4	BN5	BN5	BN8	BN9	BN10								
10	CP0	CP1	CP2	CP3	CP3	CP4	CP5	CP6	CP6	CP7	CP8						
	BN1	BN3	BN4	BN5	BN7	BN9	BN9	BN10	BN10	BN12	BN12						
12	CP0	CP1	CP2	CP4	CP4	CP4	CP5	CP6	CP6	CP7	CP8						
	BN1	BN3	BN4	BN5	BN7	BN9	BN9	BN10	BN10	BN12	BN12						
14	CP0	CP1	CP3	CP4	CP4	CP5	CP6	CP6	CP7	CP7	CP8	CP10					
	BN1	BN3	BN4	BN5	BN8	BN10	BN10	BN12	BN12	BN12	BN15	BN20					
16	CP0	CP1	CP4	CP4	CP5	CP5	CP6	CP6	CP7	CP7	CP8	CP10					
	BN1	BN3	BN4	BN5	BN8	BN10	BN10	BN12	BN12	BN12	BN15	BN20					
18	CP0	CP1	CP4	CP5	CP5	CP6	CP6	CP7	CP8	CP8	CP9	CP10					
	BN2	BN3	BN5	BN7	BN9	BN10	BN12	BN15	BN15	BN15	BN15	BN20					
20	CP0	CP1	CP4	CP5	CP5	CP6	CP7	CP8	CP8	CP9	CP9	CP10					
	BN2	BN3	BN5	BN7	BN9	BN10	BN12	BN15	BN15	BN15	BN15	BN20					
22	CP0	CP1	CP4	CP6	CP6	CP7	CP8	CP8	CP8	CP9	CP10						
	BN2	BN3	BN5	BN8	BN10	BN10	BN12	BN15	BN15	BN15	BN20						
24	CP0	CP1	CP4	CP6	CP6	CP7	CP8	CP8	CP8	CP9	CP10						
	BN2	BN3	BN5	BN8	BN10	BN10	BN12	BN15	BN15	BN15	BN20						
<b>FARM, TRACTOR, SKIDDER</b>																	
4	CP0	CP0	CP1	CP2	CP3	CP3	CP4	CP5	CPT0	CPT0	CPT1	CPT2	CPT2	CPT3	CPT3		
	BN3	BN4	BN4	BN5	BN7	BN8	BN8	BN9	BN9	BNT20	BNT20	BNT21	BNT21	BNT21	BNT22		
6	CP0	CP0	CP1	CP2	CP3	CP3	CP4	CP5	CPT0	CPT0	CPT1	CPT2	CPT2	CPT3	CPT3		
	BN3	BN4	BN4	BN5	BN7	BN8	BN8	BN9	BN9	BNT20	BNT20	BNT21	BNT21	BNT22	BNT22		
8	CP0	CP1	CP2	CP2	CP3	CP4	CP4	CP5	CPT0	CPT0	CPT1	CPT2	CPT2	CPT3	CPT3	CPT6	CPT7
	BN3	BN4	BN5	BN7	BN8	BN8	BN9	BN9	BNT20	BNT20	BNT20	BNT21	BNT21	BNT22	BNT25	BNT25	BNT25
10	CP0	CP1	CP2	CP3	CP3	CP4	CP5	CP6	CPT1	CPT1	CPT4	CPT5	CPT5	CPT6	CPT6	CPT7	CPT7
	BN3	BN4	BN5	BN7	BN8	BN8	BN9	BN9	BNT20	BNT20	BNT23	BNT24	BNT24	BNT25	BNT25	BNT25	BNT25
12	CP0	CP1	CP2	CP4	CP4	CP4	CP5	CP6	CPT4	CPT4	CPT4	CPT5	CPT5	CPT6	CPT7	CPT7	CPT7
	BN3	BN4	BN5	BN7	BN8	BN8	BN9	BN9	BNT23	BNT23	BNT23	BNT24	BNT24	BNT25	BNT25	BNT25	BNT25
14	CP0	CP1	CP4	CP4	CP4	CP5	CP6	CP6	CPT4	CPT5	CPT5	CPT5	CPT6	CPT7	CPT7	CPT7	
	BN4	BN5	BN7	BN8	BN8	BN9	BN10	BN10	BNT23	BNT24	BNT24	BNT24	BNT24	BNT25	BNT25	BNT25	
16	CP0	CP1	CP4	CP4	CP5	CP5	CP6	CP6	CPT5	CPT5	CPT5	CPT6	CPT6	CPT7	CPT7		
	BN4	BN5	BN7	BN8	BN8	BN9	BN10	BNT23	BNT24	BNT24	BNT24	BNT24	BNT25	BNT25	BNT25		
18	CP0	CP1	CP4	CP5	CP5	CP6	CPT2	CPT3	CPT5	CPT6	CPT6	CPT6	CPT6	CPT7	CPT7		
	BN5	BN7	BN8	BN9	BN9	BN10	BNT23	BNT24	BNT24	BNT24	BNT24	BNT25	BNT25	BNT25	BNT25		
<b>REINFORCEMENT REPAIRS</b>																	
8-12	CP0	CP0	CP1	CP2	CP3	CP3	CP4	CP4	CP5	CP6	CP7	CP8					
	BN1	BN2	BN3	BN3	BN4	BN4	BN5	BN8	BN9	BN10	BN12	BN15					
	AG3	AG3	AG3	AG3	AG4	AG5	AG5	AG7	AG8	AG10	AG12	AG15					
14-18	CP0	CP0	CP1	CP2	CP4	CP4	CP5	CP5	CP6	CP6	CP7	CP8					
	BN1	BN3	BN4	BN4	BN5	BN5	BN7	BN9	BN10	BN10	BN12	BN15					
	AG3	AG3	AG4	AG4	AG5	AG6	AG6	AG8	AG10	AG10	AG12	AG18					
20-24	CP0	CP0	CP2	CP4	CP5	CP5	CP6	CP6	CP7	CP7	CP8	CP9					
	BN2	BN3	BN4	BN5	BN7	BN8	BN9	BN10	BN12	BN12	BN15	BN15					
	AG3	AG3	AG4	AG5	AG6	AG7	AG7	AG10	AG12	AG12	AG15	AG18					

**USING THIS CHART:**

1. Use the appropriate section of this chart for the repair being performed.
2. Note the ply rating of the tire being repaired and locate this in the left hand column of appropriate section.
3. Measure the injury being repaired across the largest area of broken or removed cord. Locate this injury size, or next largest size listed, along the top row.
4. Use the specified repair unit where the column and row intersect.



**NOTE**

*Injury MUST be within repairable limits. Refer to page 125 for repair limitations*

## GIANT OTR REPAIR UNITS

### Giant OTR Bias Ply Repair Units

- Each reinforcing ply is protected and encased in a molded ply package making each unit strong while remaining flexible
- Designed for chemical or heat vulcanization (if heat curing, apply floater gum)
- Black vulcanizing gum, white backing

### Giant OTR Bias Ply Repair Units – Uncured

- Heavy duty construction with floater gum
- Designed for heat vulcanization
- Uncured repair unit with green poly backing

### Giant OTR Bias Ply Repair Units, Aramid Reinforced, Semi Cured

- Reinforced with aramid cord for added strength
- Designed for heat vulcanization

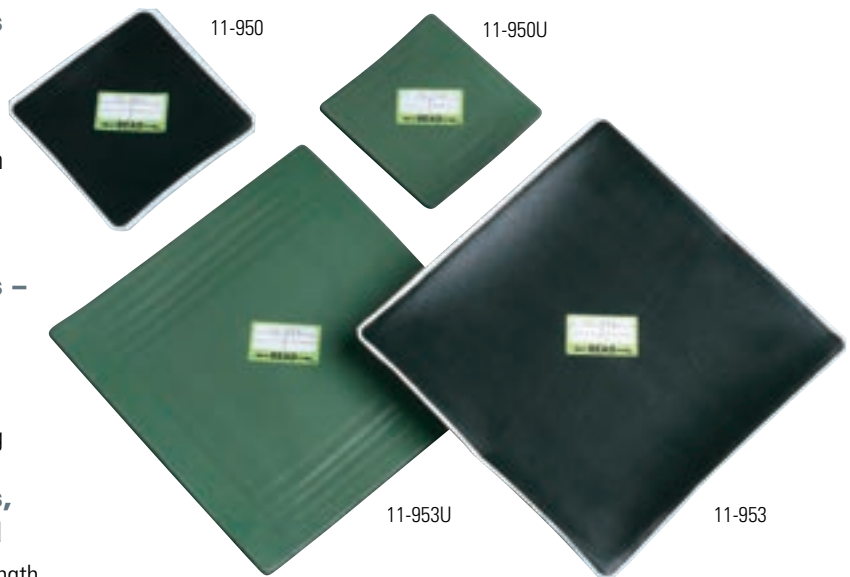

GIANT OTR BIAS PLY					
Part Number	Uncured Part Number	Description	Size (inches)	Size (mm)	Box Qty
11-950	11-950U	4-Ply	4 x 4	102 x 102	12
11-951	11-951U	4-Ply	6 x 6	152 x 152	12
11-952	11-952U	6-Ply	8 x 8	203 x 203	12
11-953	11-953U	6-Ply	10 x 10	254 x 254	12
11-954	11-954U	7-Ply	12 x 12	305 x 305	12
11-955	11-955U	8-Ply	14 x 14	356 x 356	6
11-956	11-956U	8-Ply	16 x 16	406 x 406	6
11-957	11-957U	10-Ply	18 x 18	457 x 457	3
11-958	11-958U	12-Ply	20 x 20	508 x 508	3
11-959	11-959U	12-Ply	22 x 22	559 x 559	3
11-9510	11-9510U	14-Ply	24 x 24	610 x 610	3

GIANT OTR BIAS PLY ARAMID REINFORCED – SEMI CURED			
Part Number	Size (inches)	Size (mm)	Box Qty
11-950KSC	4 x 4	102 x 102	12
11-951KSC	6 x 6	152 x 152	12
11-952KSC	8 x 8	203 x 203	12
11-953KSC	10 x 10	254 x 254	12
11-954KSC	12 x 12	305 x 305	12
11-955KSC	14 x 14	356 x 356	6
11-956KSC	16 x 16	406 x 406	6
11-957KSC	18 x 18	457 x 457	3
11-95206KSC	20 x 6	508 x 152	3
11-95227KSC	22 x 7	559 x 178	3
11-95238KSC	23 x 8	584 x 203	3

### Aramid Radial Ply Packages

- Strong and flexible Aramid cord construction
- Designed for use when “floating” repair units
- Fresh cushion, heat and pressure vulcanizing required
- Ply package only on black cloth backing
- Extended shelf life

ARAMID RADIAL PLY PACKAGES			
Part Number	Description	Size (inches)	Size (mm)
11-820AJL	Radial 20, 2 Ply	2 1/2 x 4 3/8	62 x 112
11-822AJL	Radial 22, 2 Ply	2 3/4 x 5 5/8	70 x 144
11-824AJL	Radial 24, 2 Ply	2 1/2 x 8	65 x 205
11-826AJL	Radial 26, 2 Ply	2 1/2 x 9 7/8	65 x 250
11-840AJL	Radial 40, 2 Ply	3 5/8 x 7	93 x 180
11-844AJL	Radial 44, 3 Ply	4 3/4 x 12 3/8	120 x 314
11-848AJL	4 Ply	3 1/8 x 9 3/4	80 x 248
11-849AJL	4 Ply	3 1/8 x 11 3/4	80 x 298
11-850AJL	4 Ply	3 1/8 x 13 3/4	80 x 350





## SECTION REPAIR MATERIAL & EQUIPMENT

31 Incorporated manufacturers **section repair materials** of only the highest quality cushion gum, coated cord, and fill rubber for the professional installer. Choose only XtraSeal quality repair materials to meet your section repair needs.

### Stripping Stock\*

Free flowing, quality stock for stripping edges of tread rubber to cover excess buffed surfaces. Use on sidewalls to improve appearance.

Use 14-515 or 14-516 black vulcanizing cement.

**Shelf life = 3 months**

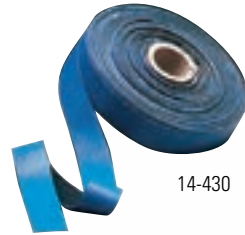

### Floater Gum\*

A must in repairing. Use underneath patch to provide a "shock absorber" to ensure longer patch life. Special flexing rubber reduces patch edge cracking and heat build-up due to "floating action".

Use 14-515 or 14-516 black vulcanizing cement with 14-435 gum.

Use 14-511 cement with 14-434 chemical gum.

**Shelf life = 3 months**

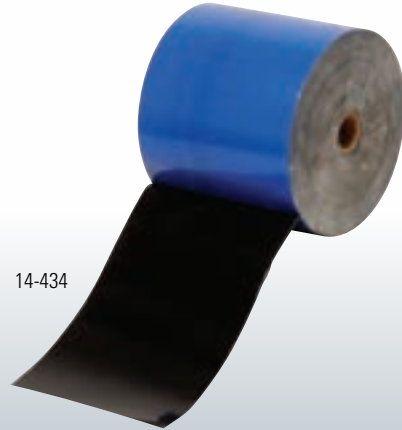

STRIPPING STOCK*				
Part Number	Description	Approx. Width	Approx. Gauge	Approx. Weight per Roll
14-430	Stripping Stock	1 1/4" (32mm)	1/16" 1.6mm)	2 lbs. .091kg

FLOATER GUM*				
Part Number	Description	Approx. Width	Approx. Gauge	Approx. Weight per Roll
14-434	Chemical Cure Only	8" (203mm)	1/32" (0.79mm)	20 lbs. 9.10kg
14-435	Heat Cure Only	8" (203mm)	1/32" (0.79mm)	20 lbs. 9.10kg

### All Purpose Cushion Gum\*

Designed for use in all types of repairing. Use in tread, sidewall and cord body filling. Excellent for buzz-outs. Replaces tread gum and innerliner gum.

Use 14-515 or 14-516 black vulcanizing cement.

**Shelf life = 3 months**

**Note:**

**50 durometer is for SIDEWALL applications.**

**64 durometer is for TREAD applications.**

14-451

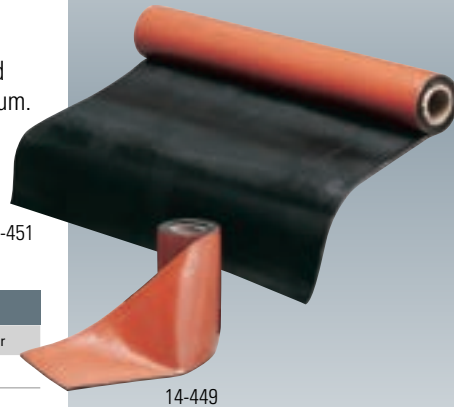

ALL PURPOSE CUSHION GUM*					
Part Number	Approx. Width	Approx. Gauge	Approx. Weight per Roll	Durometer	
14-449	5" (127mm)	1/8" (3mm)	1 lb. 0.45kg	50	
14-450	5" (127mm)	1/8" (3mm)	1 lb. 0.45kg	64	
14-451	18" (457mm)	1/8" (3mm)	10 lbs. 4.50kg	50	
14-452	18" (457mm)	1/8" (3mm)	10 lbs. 4.50kg	64	
14-453	18" (457mm)	1/8" (3mm)	20 lbs. 9.10kg	50	
14-454	18" (457mm)	1/8" (3mm)	20 lbs. 9.10kg	64	

**\* CURING INFORMATION**

**Heat Chamber:**

30 minutes at 280° F (138° C), 50 minutes at 260° F (127° C).

Cure Rate = 10 minutes for every 1/8" (3mm).

**Spotter:**

When using a cold spotter, you will have to add the manufacturer's recommended warm-up time.

### TIRE ID PATCHES

Designed for side-wall installation.

TIRE REPAIR ID PATCHES			
Part Number	Description	Box Qty	
11-333	Blue Triangle Section Repair ID patches	50	
11-341	"Retreaded in the USA" ID patches	50	11-333



11-341

### Coated Nylon Cord

Use to build reinforced repairs to tires. High tensile strength tire cord calendared with high quality skim compound to a uniform gauge.

Use 14-515 or 14-516 black vulcanizing cement.

**Shelf life = 1 year**

### Coated Aramid Cord

Extremely strong reinforcing material. Use to build reinforced repairs to tires, conveyer belting, and other types of fabric reinforced rubber goods especially in applications where it is important to minimize the gauge of the cord without compromising the strength. High tensile strength tire cord calendared with high quality skim compound to a uniform gauge.

Use 14-515 or 14-516 black vulcanizing cement.

**Shelf life = 1 year**

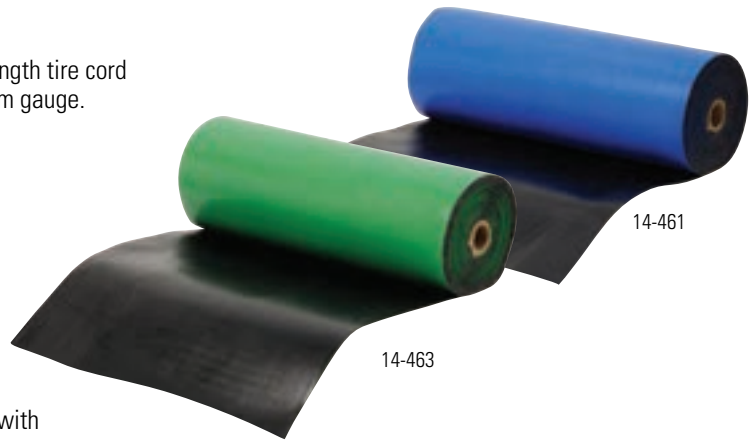

#### COATED NYLON CORD

Part Number	Description	Approx. Width	Approx. Gauge	Approx. Weight/Roll
14-461	Heat Cure	20" (508mm)	.045" (1.1mm)	20 lbs. 9.1 kg
14-462	Heat Cure	20" (508mm)	.045" (1.1mm)	50 lbs. 22.7 kg

#### COATED ARAMID CORD

Part Number	Description	Approx. Width	Approx. Gauge	Approx. Weight/Roll
14-463	Heat Cure	20" (508mm)	.045" (1.1mm)	20 lbs. 9.1 kg
14-464	Heat Cure	20" (508mm)	.045" (1.1mm)	50 lbs. 22.7 kg

**\* CURING INFORMATION**

30 minutes at 280° F (138° C), 50 minutes at 260° F (127° C).

**Cure Rate** = 10 minutes for every 1/8" (3mm).

When using a cold spotter, you will have to add the manufacturer's recommended warm-up time.

### Extruder Rope

Rubber extruded in rope form especially for mini-extruder guns. For filling buzz-outs, section repairs, cuts and snags.

Use 14-515 or 14-516 black vulcanizing cement.

**Shelf life = 3 months**

**Note: 50 durometer is for SIDEWALL applications.**

**64 durometer is for TREAD applications.**



14-465

#### EXTRUDER ROPE\*

Part Number	Diameter	Approx. Weight/Roll	Durometer
14-465	3/8" (10mm)	25 lbs. 11.3 kg	50
14-466	3/8" (10mm)	25 lbs. 11.3 kg	64

#### A & B COMPOUND

Part Number	Description	Case Qty
14-438	1 lb. (0.45 kg) A & B Compound	6 sets



14-438

### A & B Compound

Use for chemical cure spot repairs and repairs to other industrial products. A two part, A and B putty. These materials, when kneaded together in equal portions, begin to cure chemically at room temperature.

**Shelf life = 6 months.**

### Penny Patch Nail Hole Repairs for Retreaders\*

Use 14-515 or 14-516 black vulcanizing cement.

**Shelf life = 3 months**

#### PENNY PATCHES

Part Number	Description	Size	Box Qty
14-421	Reinforced	1" (25mm)	100
14-422	Reinforced	1 1/2" (38mm)	100
14-423	Reinforced	2" (50mm)	100



14-421

14-422

14-423

## LINCOLN VULCANIZING EQUIPMENT

The full line of Lincoln vulcanizing equipment, replacement parts, and accessories is available. Ask for details.

### 14-LMC200 Tube Plate Vulcanizer

- Economical and easy to use.
- Heat unit with snap-type thermostat reaches curing temperature fast.
- Detachable flat plate for vulcanizing valve stems.



14-LMC200

### 14-LMC400B Truck Tire Vulcanizer

- Lightweight, tubular steel frame (easy to handle).
- Faster travel, Acme thread handwheel screw.
- Larger capacity frame allows repairs in tires thru 12.00 cross section.
- High performance heat units feature platen mounted preset (European approved) thermostats which reduces heat-up time to 5 minutes.



14-LMC400B



T150 : Optional 8 Plate Set  
T038 : Replacement Bottom Heat Unit  
T039 : Replacement Upper Heat Unit

### 14-LMC2000 Air Operated Truck Tire Vulcanizer

- The ultimate flexibility in tire repair!
- The only spotter in the market that handles tread, shoulder, and sidewall repairs on all kinds of tires from low profile to super singles. Easily adapts to future tire sizes simply by changing the contour plates.
- Patented piston/pad system for expert repairs even by novice operators.
- Inside-outside heat system.
- Spring loaded mechanical pressure with solid heat units for tread and shoulder repairs.
- Extremely economical - No expensive air bags to replace.
- Optional large-capacity stand supports both tire and vulcanizer with dual 16" rollers for easy tire rotation.



14-LMC2000

T156 : Optional 9 Plate Set

### 14-LMC1000 Large Truck-Tractor Vulcanizer

- Spring loaded lower heat unit maintains even pressure throughout the curing process eliminating frequent re-tightening of heat units.
- Lower telescoping assembly slides back for quick mounting or removal of spotter then locks into position for use.
- Acme threaded adjusting screw for upper heat unit.
- Solid one-piece frame is easy to handle and weighs only 30 lbs.
- 3 5/16" diameter round heat units fit into close quarters for small repairs yet have wattage output to handle adapter plates for large repairs.
- Use for spot and section repairs in all truck, tractor, and many off road tires.



14-LMC1000

T152 : Optional 12 Plate Set

LINCOLN VULCANIZING EQUIPMENT							
Part Number	Description	Curing Heads	Throat Depth	Throat Height	Throat Height B	Voltage Options	Shipping Weight
14-LMC200	Tube Plate Vulcanizer	1 – 4" x 6" (10.2 x 15.2cm)	6" (15cm)			120V or 240V	27 lbs. (12.3kg)
14-LMC400B	Truck Tire Vulcanizer	2 – 3 5/16" (8.4cm)	6.25" (15.8cm)	9.75" (24.7cm)	15.375" (39cm)	115V or 230V	14 lbs. (6.4 kg)
14-LMC2000	Air Operated Truck Tire Vulcanizer	3 – 6" (15.2cm)	11.5" (29.2cm)	24.5" (62.2cm)		120V or 240V	74 lbs. (33.6 kg)
14-LMC1000	Large Truck-Tractor Vulcanizer	2 – 3 5/16" (8.4cm)	14.5" (36.8cm)	16" (40.6cm)		120V or 240V	30 lbs. (13.6 kg)

## REGROOVERS & HEAT KNIVES



**14-470**

### PS15 Standard® Regroover

This high quality regroover has the rugged reliability of the more sophisticated PS15 Truckstar. The PS15 Standard® is an excellent basic regroover featuring a dial knob heat control with 4 heat presets, large cutting head, comfortable, ergonomically designed handle, and has a 370 watt transformer. A safety feature prevents the block assembly and blade from heating up until contact is made when regrooving begins.



14-470

**14-470T**

### PS15 Truckstar Plus® Regroover

The PS15 Truckstar Plus® is a more sophisticated regrooving unit with a large cutting head, and a comfortable, ergonomically designed handle. The digital heat control keys, which have now been integrated into the new electronic board, make the unit more reliable and allows the heat output to be regulated at close to 1%. The 500 watt transformer of the PS15 Truckstar Plus® makes regrooving easier by saving the operator time and energy as the blade slips easily through the rubber. A safety feature prevents the block assembly and blade from heating up until contact is made when regrooving begins.



14-470T

**14-470OTR**

### PS15 OTR® Regroover

The PS15 OTR® is designed specifically for regrooving off road and heavy equipment tires. This unit features a dial knob heat control with 5 heat presets, large cutting head, and comfortable, ergonomically designed handle. With its 1000 watt transformer and heavy duty cables, this unit easily handles intensive regrooving with R5, C5, and C6 large blades. A safety feature prevents the block assembly and blade from heating up until contact is made when regrooving begins.



14-470OTR

- Our blades can be fitted to any regroover •
- Any regrooving blades can be fitted to our regroovers •

**14-478**

### HC1000 Heat Knife

The HC1000 Heat Knife is designed for cutting rubber and plastics. The digital heat controls allow regulation of the heat output of the 370 watt transformer at close to 1%. The blade heats up only when the operators hand is in contact with the metallic key on the handle of the tool.



14-478



# REGROOVER REPLACEMENT PARTS & ACCESSORIES

## Regroover Blades

- Very high quality due to our exclusive double sharpening system on a specific steel.



### REPAIRtips

Our blades can be fitted to any regroover. Any regrooving blades can be fitted to our regroovers.

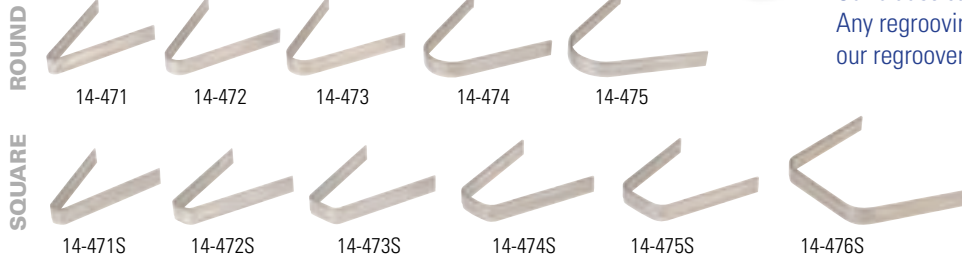

### REGROOVER BLADES - ROUND

Part Number	Description	Cutting Width (mm)	Box Qty
14-471	#1 Round Blade (R1)	3-5mm	20
14-472	#2 Round Blade (R2)	5-11mm	20
14-473	#3 Round Blade (R3)	7-13mm	20
14-474	#4 Round Blade (R4)	9-16mm	20
14-475	#5 Round Blade (R5)	11-18mm	20

### REGROOVER BLADES - SQUARE

Part Number	Description	Cutting Width (mm)	Box Qty
14-471S	#1 Square Blade (C1)	3-5mm	20
14-472S	#2 Square Blade (C2)	6-10mm	20
14-473S	#3 Square Blade (C3)	8-12mm	20
14-474S	#4 Square Blade (C4)	10-14mm	20
14-475S	#5 Square Blade (C5)	12-17mm	20
14-476S	#6 Square Blade (C6)	20-28mm	10

### REGROOVER PARTS & ACCESSORIES

Part Number	Description
14-470B	Replacement Block Assembly for 14-470
14-470TB	Replacement Block Assembly for 14-470T
14-470H	Handle / Cord Assembly for 14-470
14-470TH	Handle / Cord Assembly for 14-470T
14-470-1	Allen Wrench for 14-470
14-470-2	Wood Handle Wrench for 14-470T
14-470-3	Replacement Switch for 14-470
14-470-4	Power Cord for 14-470T
14-470-5	Brass Wedge Set for Block Assembly
14-470-6	Blade Screw Set for Block Assembly
14-470-7	Regroover Blade Depth Gauge
14-470-8	Yellow Replacement Cable

### HEAT KNIFE BLADES

Part Number	Description	Box Qty
14-471H	#1 Heat Knife Blade	5
14-472H	#2 Heat Knife Blade	5
14-473H	#3 Heat Knife Blade	5

## Heat Knife Blades

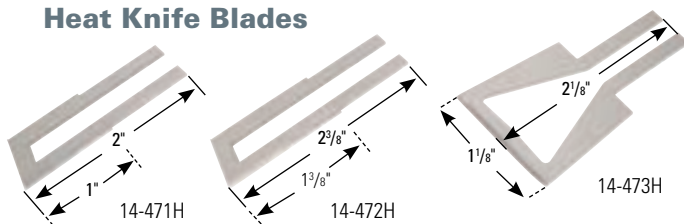

## Regroover Replacement Parts & Accessories



We manufacture the widest array of tire service chemicals in the industry today. Most chemicals are available in 1, 5 and 55 gallons. Ask for details.

## TIRE REPAIR CHEMICALS

### Vulcanizing Cement

- Our most popular, **fast drying** cement
- For chemical or heat vulcanization.
- For use with any XtraSeal repair unit or insert

VULCANIZING CEMENT			
Part Number	Size		Case Qty
14-004	4 oz. (118ml)	Flammable	12
14-008	8 oz. (236ml)	Flammable	24
14-032	32 oz. (945ml)	Flammable	12
14-513	8 oz. (236ml)	Non-Flammable	24
14-514	32 oz. (945ml)	Non-Flammable	12



### Heavy-Duty Super-Blu Vulcanizing Cement

Contains more rubber solids than our regular cement for a stronger bond.

HEAVY-DUTY SUPER-BLU VULCANIZING CEMENT			
Part Number	Size		Case Qty
14-511	8 oz. (236ml)	Flammable	24
14-512	32 oz. (945ml)	Flammable	12



### Black Retreader's Cement

For use in heat vulcanizing only (not for chemical vulcanization).

BLACK RETREADER'S CEMENT			
Part Number	Size		Case Qty
14-515	32 oz. (945ml)	Flammable	12
14-516	32 oz. (945ml)	Flammable	12
	Heavy Duty		

### Bead "BUSTR"

Penetrates to help free stubborn beads from the wheel making demounting easier.

BEAD "BUSTR"			
Part Number	Size		Case Qty
14-771	32 oz. (945ml)	Flammable	12
14-772	1 Gallon (3.8L)	Flammable	4

### Inner Liner Sealer

For sealing the over-buff area around a finished repair.

INNER LINER SEALER			
Part Number	Size		Case Qty
14-128A	16 oz. (472ml)	Flammable	12

APPLICATORS	
Part Number	Description
14-380	Cement Brush (Bag of 50)
14-381B	Replacement Brush Lid for Quart Round Can



## Rubber Prep

For removing dirt, debris and mold lubricants from the repair area prior to buffing.

RUBBER PREP PRE-BUFF SOLUTION				
Part Number	Description	Size	Flammable	Case Qty
14-100	Rubber Prep	32 oz. (945ml)	Flammable	12
14-100GAL	Rubber Prep	1 Gallon (3.8L)	Flammable	4
14-102	Rubber Prep	16 oz. Aerosol	Non-Flammable	12
14-103	Rubber Prep	16 oz. Aerosol	Flammable	12
14-490	Rubber Prep	32 oz. (945ml)	Non-Flammable	12



14-100

14-102

14-103

14-101

## Bead Sealer

For sealing small air leaks between the tire bead and the wheel.

BEAD SEALER				
Part Number	Description	Size	Flammable	Case Qty
14-101	Bead Sealer (Standard)	32 oz. (945ml)	Flammable	12
14-101A	1X Heavy Duty Bead Sealer	32 oz. (945ml)	Flammable	12
14-101B	2X Heavy Duty Bead Sealer	32 oz. (945ml)	Flammable	12
14-101GAL	Bead Sealer (Standard)	1 Gallon (3.8L)	Flammable	4
14-104	Bead Sealer (Standard)	5 Gallons (18.9L)	Flammable	1
14-104A	1X Heavy Duty Bead Sealer	5 Gallons (18.9L)	Flammable	1



14-101

14-104

14-154

OTHER XTRAS SEAL SOLUTIONS				
Part Number	Description	Size	Flammable	Case Qty
14-550	Tire Talc in Sifter Can	1 lb. (0.45kg)		12
14-760	Air Tool Oil	32 oz. (945ml)		12
14-154	Black Tire Paint, Water Based Ready-To-Use for Spray or Brush Applications	5 Gallon (19L)		-
14-156	Black Tire Paint Concentrate (Water Based)	5 Gallon (19L)		-

## APPEARANCE CHEMICALS

TIRE CLEANING SOLUTIONS				
Part Number	Description	Mix with Water Ratio	Flammable	Case Qty
14-754	Whitewall Cleaner	32 oz. (945ml)	Mix 1:1	12
14-754GAL	Whitewall Cleaner	1 Gallon (3.8L)	Mix 1:1	4
14-758	Shine-All Protectant	32 oz. (945ml)	Ready to Use	12
14-758GAL	Shine-All Protectant	1 Gallon (3.8L)	Ready to Use	4



14-754

14-758

XTRAS SEAL APPEARANCE CHEMICAL				
Part Number	Description	Mix with Water Ratio	Flammable	Case Qty
14-765	Liquid Car Wash	1 Gallon (3.8L)	128:1	4
14-756	Summer Service Island Window Cleaner Concentrate	1 Gallon (3.8L)	10:1	4
14-757	Winter Service Island Window Cleaner Concentrate	1 Gallon (3.8L)	6:1	4
14-767	Super Clean Glass Window Cleaner Concentrate	1 Gallon (3.8L)	128:1	4



14-765

14-756

14-767

Most chemicals are available in 1, 5 and 55 gallons.



## TIRE MOUNTING / DEMOUNTING COMPOUNDS & ACCESSORIES

To prevent damage to tire beads and to ease the mounting and demounting process, choose the compounds used by tire professionals worldwide.

### XtraSeal TIREPASTE

A wax paste lubricant that works great with low pro, run flat, and alloy wheel applications.

- Very slippery
- No mixing
- No water
- Dries tacky
- Rust inhibitors



14-699  
8.75" dia x 4.75" tall



14-700  
7.50" dia x 6.00" tall



14-701  
8.75" dia x 7.50" tall

XtraSeal TIREPASTE			
Part Number	Description	Case Qty	
14-699	6 1/2 lb. (3kg) XtraSeal TIREPASTE, White in Low-Profile Bucket	4	
14-700	6 1/2 lb. (3kg) XtraSeal TIREPASTE, White	4	
14-701	11 lb. (5kg) XtraSeal TIREPASTE, White	4	
14-705	6 1/2 lb. (3kg) XtraSeal TIREPASTE, Blue	4	
14-706	11 lb. (5kg) XtraSeal TIREPASTE, Blue	4	
14-700E	6 1/2 lb. (3kg) Econo-Paste, White	4	
14-701E	11 lb. (5kg) Econo-Paste, White	4	



14-705  
7.50" dia x 5.00" tall

14-706  
8.75" dia x 7.50" tall



14-725E



14-725



14-751



14-753PM

### Mounting/Demounting Compound

A vegetable base compound with rust inhibitors which greatly reduces the chance of bead damage.

- Great for packing beads
- For use with all types of tires
- Biodegradable
- Can be mixed with water 1.5 lbs for one gallon
- Economical

### Liquid Mount/Demount Lubricants

Ready to use and lube packet concentrate.

- Xtra-Slik is ready to use
- Dries quickly
- Prevents slippage on the bead
- Rust inhibitor
- 14-751 lube concentrate packet makes one gallon
- Economical

MOUNTING/DEMOUNTING COMPOUND			
Part Number	Description	Case Qty	
14-708E	8 lb. (3.64kg) XtraSeal	4	
14-725E	25 lb. (11.36kg) XtraSeal	1	
14-708	8 lb. (3.64kg) MURPHY'S	4	
14-725	25 lb. (11.36kg) MURPHY'S	1	
14-740	40 lb. (18.18kg) MURPHY'S	1	

TIRE MOUNTING/DEMOUNTING LUBRICANT			
Part Number	Description	Case Qty	
14-751	13 oz. (386ml) Mix with 1 Gallon Water	10	
14-752	32 oz. (945ml) Ready to Use	12	
14-753	1 Gallon (3.8L) Mix 4:1 with Water	4	
14-753PM	1 Gallon (3.8L) Ready to Use	4	



## No Rim Rust Black Mounting/Demounting HD compounds

A vegetable base compound with rust inhibitors which greatly reduces the chance of bead damage.

- Increased rust inhibitors for truck rims
- Lubricates beads with thick viscosity
- Premium formula
- Used by many national fleets to reduce rim expense



14-749E



14-749

NO RIM RUST			
Part Number	Description		Case Qty
14-748E	5 lb. (2.27kg)	XtraSeal	6
14-749E	25 lb. (11.36kg)	XtraSeal	1
14-748	4 1/2 lb. (2.05kg)	Freylube	6
14-749	25 lb. (11.36kg)	Freylube	1

## Mounting / Demounting Accessories

APPLICATORS	
Part Number	Description
14-378	11" (279mm) Cotton Tire Swab
14-378L	15" (381mm) Cotton Tire Swab
14-711	Tire Paste Applicator Brush, 1" Diameter
14-712	Small Applicator Brush, 1 1/2" Diameter
14-713	Large Applicator Brush, 2" Diameter



ACCESSORIES	
Part Number	Description
14-720	Small Mounting Ring for Paste, 6 3/4" Diameter
14-721	Large Mounting Ring for Paste, 8" Diameter
17-996	Lube Bucket for Center Post Tire Changers
17-997	Lube Bucket for Rim Clamp Tire Changers

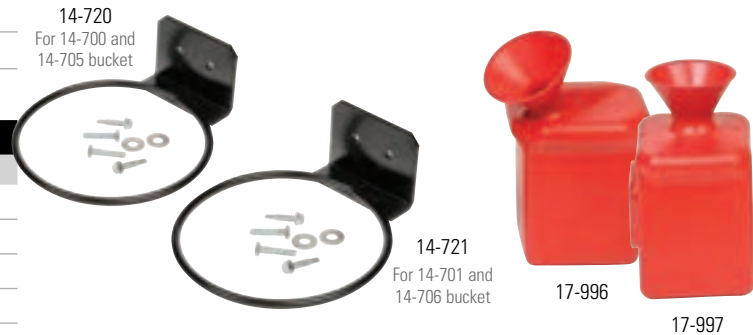

REPAIR TESTING NECESSITIES	
Part Number	Description
14-755	Leak Seeker Concentrate 8 oz. – Mix 8:1
14-955	Standard Tire and Tube Test Tank Inside Dimensions: 31" x 12.75" x 12.75"
14-956	Large Tire and Tube Test Tank Inside Dimensions: 35" x 15.5" x 17"

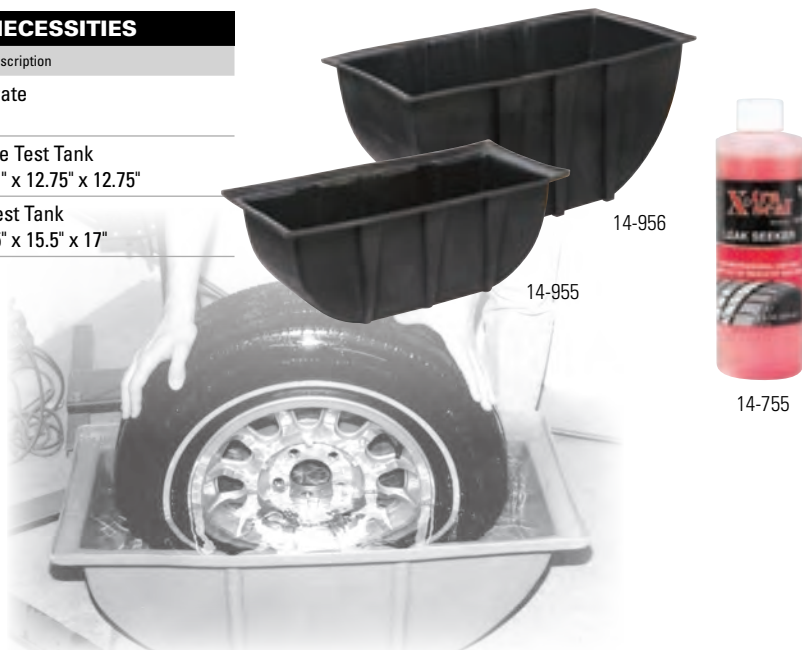

## PUNCTURE REPAIR | INSERTS

### Lead-Wire Inserts

- For use in radial and bias ply tires
- Dipped or wrapped with vulcanizing gum
- Designed for chemical or heat vulcanization

#### LEAD-WIRE INSERTS - DIPPED STEM

New Part Number	Old Part Number	Injury Size	Box Qty	Case Qty	Carbide
12-412	13-621	3/16" (4.5mm)	20	10	14-345
12-413	13-620	1/4" (6mm)	20	10	14-346
12-414	13-622	5/16" (8mm)	20	10	14-347
12-415	13-623	3/8" (10mm)	20	10	14-348

#### LEAD WIRE INSERTS - WRAPPED

12-412C	13-621C	3/16" (4.5mm)	20	10	14-345
12-413C	13-620C	1/4" (6mm)	20	10	14-346
12-414C	13-622C	5/16" (8mm)	20	10	14-347
12-415C	13-623C	3/8" (10mm)	20	10	14-348

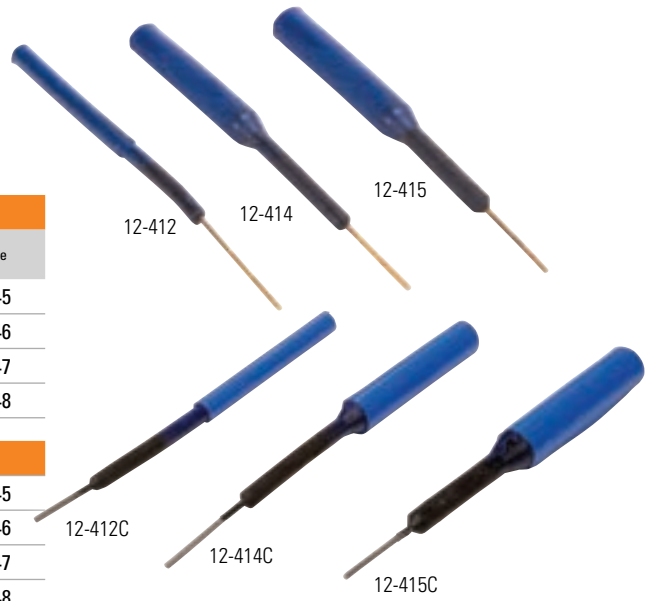

### Pull Thru Inserts

- Dip coated with premium blue vulcanizing gum
- For use in radial and bias ply tires
- Designed for chemical or heat vulcanization
- Install using 14-200 wire puller

#### PULL-THRU INSERTS

Part Number	Injury Size	Box Qty	Case Qty	Carbide Cutter
13-632	3/16" (4.5mm)	20	10	14-346
13-633	5/16" (8mm)	20	10	14-347
13-634	3/8" (10mm)	5	10	14-348
13-635	9/16" (14mm)	5	10	14-349
13-636	3/4" (19mm)	5	10	-
13-637	1" (25mm)	5	10	-
13-638	1 1/4" (31mm)	5	10	-
14-200	Wire Installation Tool for 13-632 - 13-638	1	-	-



### X-tra Smooth Inserts

- Install 1/4" inserts using 12-101 or 12-241 insert gun

#### X-TRA SMOOTH INSERTS

Part Number	Description	Size (inches)	Size (mm)	Box Qty	Case Qty
12-100	X-tra Smooth Plug Kit, Contains: 1 ea. 12-101, 1 can 12-107, 1 can 14-008, 1 ea. 14-211			1 Kit	6
12-101	X-tra Smooth Plug Insert Gun			-	-
12-103	Cleaning Brush for 12-101 Plug Gun			-	-
12-107	1 3/8" Orange Vulcanizing Insert	1/4	6	50	24
12-107L	1 7/8" Orange Vulcanizing Insert	1/4	6	30	24



### Gray Gum Poly Wrapped Inserts

- Install using any open-eye needle

GRAY GUM POLY WRAPPED INSERTS					
Part Number	Description	Size (inches)	Size (mm)	Box Qty	Case Qty
12-203	2" Round Insert, (50mm)	3/16	5	20	24
12-205	8" Round Insert, (203mm)	3/16	5	20	10
12-206	2" Oval Insert, (50mm)	1/4 x 5/16	6 x 8	20	24
12-207	8" Oval Insert, (203mm)	1/4 x 5/16	6 x 8	20	10
12-209	8" Lg. Oval Insert, (203mm)	5/16 x 7/16	8 x 11	10	10

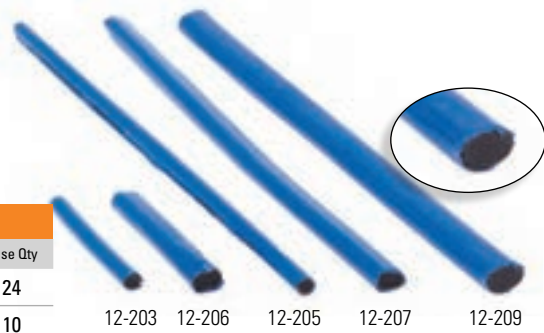

### Fibre-Seal Inserts

- Designed for chemical vulcanization
- Rubber with fiber core wrapped in gray gum and blue poly
- Install using any split-eye needle

FIBRE-SEAL INSERTS					
Part Number	Description	Size (inches)	Size (mm)	Box Qty	Case Qty
12-221	Fibre-Seal Kit Contains: 1 box 12-220, 1 can 14-008, 1 ea. 14-204, 1 ea. 14-216, 15 ea. 11-311, 1 repair booklet			1 Kit	6
12-220	Fibre-Seal Insert	3 3/4	95	50	10
12-224	Fibre-Seal Insert	5 1/4	133	40	10
12-226	Fibre-Seal Insert	7 1/2	190	25	10



### Vulcanizing Inserts

- For use in radial and bias ply tires
- For chemical vulcanization
- Install using any split-eye needle

VULCANIZING INSERTS					
Part Number	Description	Size (inches)	Size (mm)	Box Qty	Case Qty
12-222	Vulcanizing Inserts	3 3/4	95	50	10

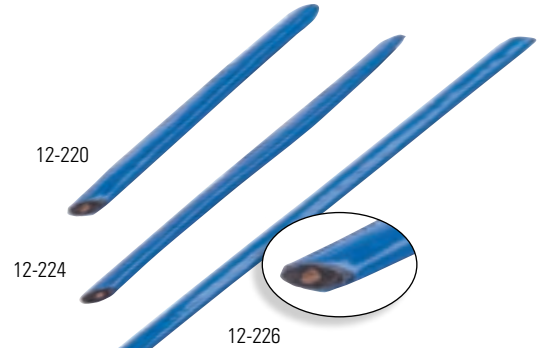
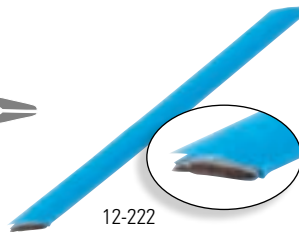

### Fiber-Fill Inserts

- For use in radial and bias ply tires
- For chemical vulcanization
- Install using any split-eye needle

FIBER-FILL INSERTS					
Part Number	Description	Size (inches)	Size (mm)	Box Qty	Case Qty
12-218	1/8" Insert, Red Poly	3 7/8	98	50	10
12-218-5.25	1/8" Insert, Red Poly	5 1/4	133	50	10
12-218-7.50	1/8" Insert, Red Poly	7 1/2	190	50	12
12-219	1/4" Insert, Blue Poly	3 7/8	98	50	10
12-219-5.25	1/4" Insert, Blue Poly	5 1/4	133	50	10
12-219-7.50	1/4" Insert, Blue Poly	7 1/4	190	50	12

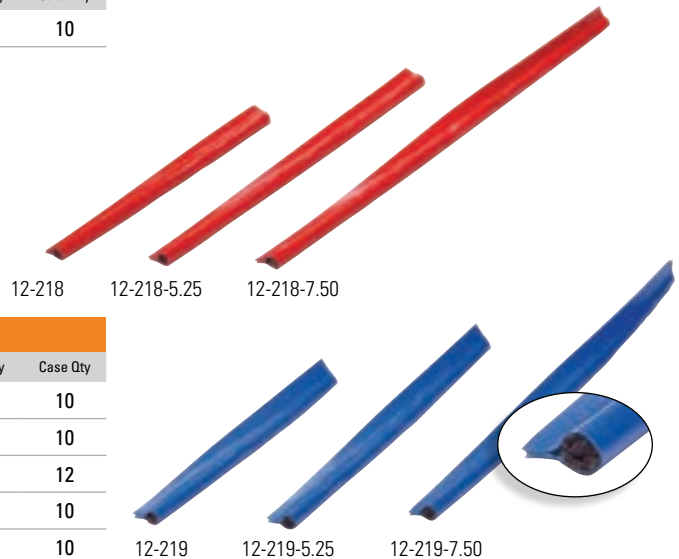

### Bowtie and Sawtooth Style Inserts

- For use in radial and bias ply tires
- Designed for chemical vulcanization
- Install using any open-eye needle

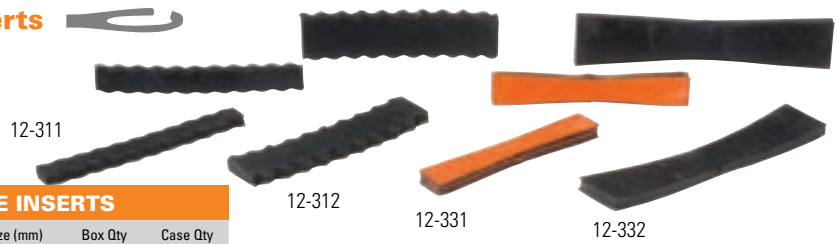

BOWTIE AND SAWTOOTH STYLE INSERTS					
Part Number	Description	Size (inches)	Size (mm)	Box Qty	Case Qty
12-311	3-Ply Sawtooth	2 3/8 x 1/4	60 x 6	50	24
12-312	3-Ply Sawtooth	2 3/8 x 1/2	60 x 13	25	24
12-331	5-Ply Bowtie, Orange	2 1/4 x 3/8	57 x 10	50	24
12-332	5-Ply Bowtie, Black	3 1/8 x 5/8	70 x 16	25	24

### XtraSeal Wedge™ Inserts

- Specially designed to repair any injury (small, medium, or large) up to 1/4" in diameter
- Two plies of highly elastic black rubber with three plies of premium blue vulcanizing gum make this the ideal repair
- For use in radial and bias ply tires
- Designed for chemical vulcanization
- Install as directed using any split-eye needle
- Illustrated instructions in every box



**How to use the Wedge™ most effectively:**



XTRASEAL WEDGE™ INSERTS					
Part Number	Description	Size (inches)	Size (mm)	Box Qty	Case Qty
12-333	XtraSeal Wedge™	2 1/4 x 3/8	57 x 10	50	24
12-335	XtraSeal Wedge™ Kit, Contains: 2 boxes 12-333, 1 can 14-008, 1 ea. 14-204, 1 ea. 14-216			1 Kit	8

### Mushroom Style Inserts

- 12-234 and 12-239 are temporary repairs sealing by compression only
- 12-213 and 12-214 will vulcanize chemically or in a heat curing system
- Install using 12-241 insert gun



MUSHROOM STYLE INSERTS					
Part Number	Description	Size (inches)	Size (mm)	Box Qty	Case Qty
12-210	Mushroom Plug Kit, Contains: 2 boxes 12-213, 1 box 12-214, 1 ea. 12-241, 1 can 14-009, 1 ea. 14-211			1 Kit	6
12-213	Orange Vulcanizing Insert	5/16	8	25	24
12-214	Orange Vulcanizing Insert	7/16	11	15	24
12-234	Black Insert	5/16	8	25	24
12-239	Black Insert	7/16	11	15	24
12-241	Mushroom Plug Gun with Small & Large Nozzles			1	20
12-922	Small Gun Nozzle (use with 12-213 & 12-234)			1	
12-923	Large Gun Nozzle (use with 12-214 & 12-239)			1	





## UNIVERSAL STRING-TYPE INSERTS

Universal string-type Inserts are an excellent emergency repair when a full service repair facility is unavailable. Made of a butyl rubber, these inserts are very strong, allowing easy insertion through steel belted radials. Perfect for repairing lawn tractor, golf cart, ATV, and other off-road tires.

- Temporary repairs sealing by compression only
- For use in radial and bias ply tires
- Excellent for golf carts, lawn mowers, and ATV's
- Install 12-370 and 12-371 using any closed-eye needle
- Install all other string type inserts using any split-eye needle

31 Inc. does NOT recommend "on the wheel" tire repairing. All XtraSeal inserts perform the function of filling the injury as recommended by the RMA and other industry associations.

See page 126 of this catalog for illustrated industry recommended repair procedures.

STRING-TYPE INSERTS					
Part Number	Description	Size (inches)	Size (mm)	Box Qty	Case Qty
<b>12-360JPN</b>	Medium Fat, Brown String	4	102	50	24
<b>12-360</b>	Fat, Brown String	4	102	30	24
<b>12-360/60</b>	Fat, Brown String	4	102	60	24
<b>12-361</b>	Fat, Brown String	4	102	50	24
<b>12-362</b>	Fat, Brown String	8	204	25	24
<b>12-370</b>	Thin, Black String	7 1/4	184	50	24
<b>12-371</b>	Thin, Black String	12	305	50	24
<b>12-394</b>	Medium Fat, Black String	4	102	50	24
<b>12-395</b>	Medium Fat, Black String	8	204	25	24
<b>12-395/50</b>	Medium Fat, Black String	8	204	50	24
<b>12-390</b>	Fat, Black String	4	102	30	24
<b>12-390/60</b>	Fat, Black String	4	102	60	24
<b>12-391</b>	Fat, Black String	4	102	50	24
<b>12-392</b>	Fat, Black String	8	204	25	24

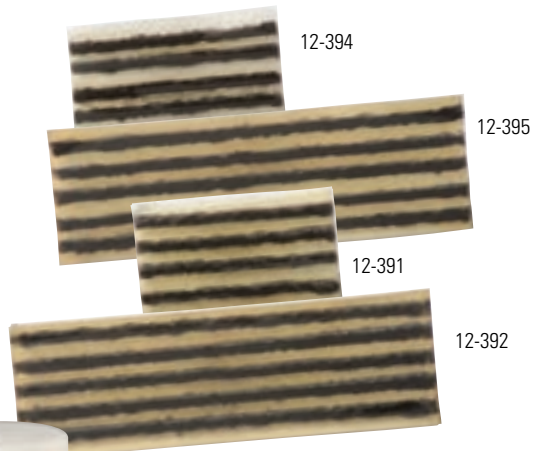
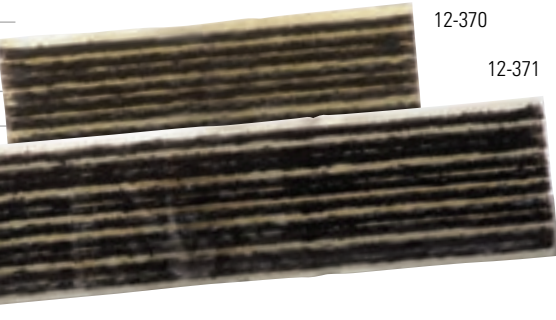
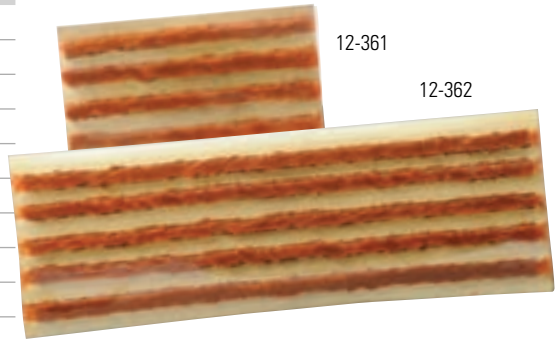

ACCESSORIES FOR STRING-TYPE INSERTS	
Part Number	Description
<b>12-350</b>	Lubricant for String-Type Inserts
<b>12-351</b>	Knife for String Kits



## EMERGENCY REPAIR KITS

31 Inc. offers the most extensive range of **string-type repair kits** on the market today. Options extend from value-economical to commercial strength quality and dependability. Each kit includes 31 Inc. genuine manufactured string-type inserts famous for strength and durability.

### Universal String-Type Repair Kits

- Includes 31 Inc. genuine 12-361 or 12-362 string-type inserts
- Temporary repairs seal the injury by compression
- Great for emergency repair whenever a full-service facility is not immediately available
- Excellent for golf carts, lawn tractors, ATV, and other off-road tire applications



12-353

HEAVY DUTY COMPOSITE SERIES			
Part Number	Description		Case Qty
12-353	Premium Passenger Kit	50 pcs. 12-361	6
12-354	Premium Truck Kit	25 pcs. 12-362	6

#### HEAVY DUTY COMPOSITE KITS ALSO INCLUDE

1 ea. 14-219, 1 ea. 14-221, 1 ea. 14-217R,  
1 jar lubricant, 1 razor knife and repair guide

HEAVY DUTY METAL SERIES			
Part Number	Description		Case Qty
12-355	HD Passenger Kit – Metal T-Handles	50 pcs. 12-361	6
12-356	HD Passenger Kit – Chrome T-Handles		6
12-357	HD Truck Kit – Metal T-Handles	25 pcs. 12-362	6
12-358	HD Truck Kit – Chrome T-Handles		6

12-356 | 12-358  
Chrome T-Handles

#### METAL HANDLED KITS ALSO INCLUDE

1 ea. 14-217, 1 ea. 14-218, 1 ea. 14-217R,  
1 jar lubricant, 1 razor knife and repair guide

#### CHROME HANDLED KITS ALSO INCLUDE

1 ea. 14-317, 1 ea. 14-317S, 1 ea. 14-317R,  
1 jar lubricant, 1 razor knife and repair guide



12-355

12-355 | 12-357  
Metal T-Handles

**POLY TOTE SERIES**

Part Number	Description		Case Qty
<b>12-361TOTE</b>	Passenger String Tote Kit	50 pcs. 12-361	10
<b>12-362TOTE</b>	Truck String Tote Kit	25 pcs. 12-362	10

**STRING-TYPE POLYTOTES ALSO INCLUDE**

1 ea. 14-204, 1 ea. 14-216, 1 jar lubricant, 1 razor knife and repair booklet



**POLYTOTES**  
12-361TOTE shown



**TOOLBOX SERIES**

Part Number	Description		Case Qty
<b>12-361KIT</b>	Passenger String Toolbox Kit	50 pcs. 12-361	6
<b>12-362KIT</b>	Truck String Toolbox Kit	25 pcs. 12-362	6

**STRING TOOLBOX KITS ALSO INCLUDE**

12-361, 1 can 14-008, 1 ea. 14-204, 1 ea. 14-216, 15 pcs. 11-311 and repair booklet

**TOOLBOX KITS**  
12-361KIT shown

**ALL KITS FEATURE GENUINE 31 INC. MANUFACTURED INSERTS**

**Quality known worldwide.  
Famous for durability and strength.**

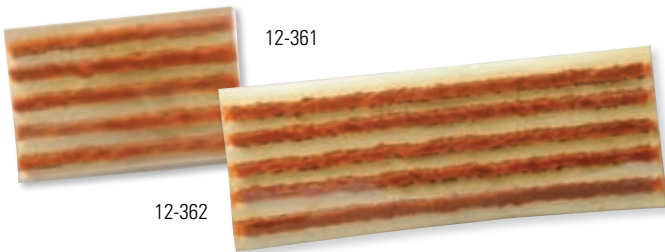

31 Inc. does NOT recommend "on the wheel" tire repairing. All XtraSeal inserts perform the function of filling the injury as recommended by the RMA and other industry associations.

See page 126 of this catalog for illustrated industry recommended repair procedures.



**See page 41 for tools!**



In order to effectively complete the job, technicians must have the right tools in place. 31 Inc. offers a system of tools and accessories engineered for the application of XtraSeal tire repair materials.



**14-987  
Tire Spreader**

**HEIGHT:** 36" (91cm) from floor to top of rollers  
**WEIGHT:** 50 lbs (23Kg)

**Heavy-Duty Tire Spreader**

- Simple & Durable Design Makes Tire Service Faster And Easier
- Heavy Duty Steel Construction
- Industrial Strength Hardware
- Sturdy & Effective Assembly (no unnecessary swivel and tilt wobble)
- Extra-Large Floor Plate
- Balanced Free-Standing Usage

**SPREADER MECHANISM INCLUDES**

- Claw height adjustment for stabilizing low-profile tires
- Locking pin secures claw arms in place
- Adjustable range to handle all passenger and light truck tires
- Larger dual roller-pin assembly

**14-987-1  
Supply Management Upgrade Kit**

Includes 2 large trays and adjustable feet

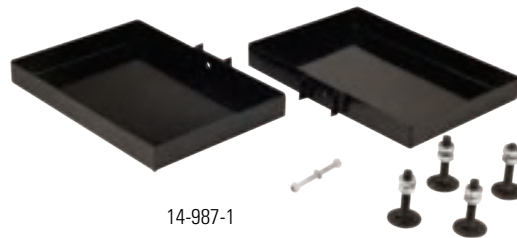

14-987-1



14-988



14-989



14-989A

**TIRE SPREADERS AND ACCESSORIES**

Part Number	Description
14-987	Heavy Duty Tire Spreader
14-987-1	Supply Management Upgrade Kit
14-987-4	Light Bracket for 14-924 Work Lamp
14-988	M-1 Style Manual Truck Tire Spreader
14-989	Top Post Mounting Passenger Tire Spreader
14-989A	Rim Clamp Adapter Plate for Top Post Spreader





# XLIGHT®

**DESIGNED FOR HANDS-FREE LIGHTING DURING TIRE SERVICE AND OTHER WORK APPLICATIONS**



**14-921  
Tire Service  
LED Work Light**

With Lithium-Ion Rechargeable Battery



- 12" Adjustable Sprint-Tube for Optimum Light Positioning within Tight Spaces
- Compact High-Power LED Light provides up to 300 LUX for Intense Focus and Optimum Visibility
- Clamp-On Handle Quickly and Easily "Grips" Over the Bead of a Tire for Complete Hands-Free Light Assistance
- Multiple High-Power Magnets on the Handle and Light Head to Easily Attachment to most Metal Surfaces
- Unique Design Provides Unlimited Vehicle Service and Work Applications
- Lithium-Ion Rechargeable Battery Included



14-921

- *Compatible with passenger, light truck and commercial truck tires*
- *Compatible with all tire spreaders*

XLIGHT & REPLACEMENT PARTS	
Part Number	Description
14-921	Tire Service LED Work Light
14-921-3	Charger for USA
14-921-4	Light Unit
14-921-5	Clamp
14-921-6	Gooseneck

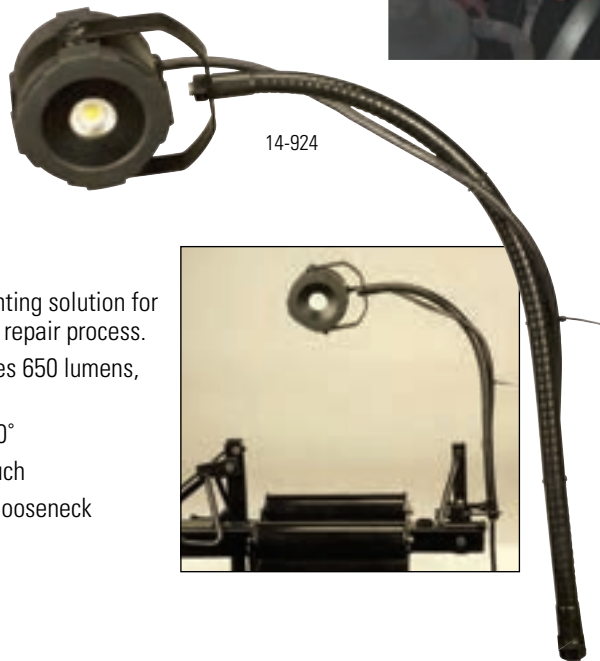

14-924

**14-924  
LED Work Lamp**

Provides an enhanced lighting solution for a proper and efficient tire repair process.

- 8W COB LED provides 650 lumens, 750 lux at 1m
- Illumination angle 90°
- Stays cool to the touch
- Adjustable flexible gooseneck 500mm (19.6")



**14-987-4  
Light Bracket**

Attaches the 14-924, LED work light, securely to the 14-987 tire spreader.



**ALL THE SMALL TOOLS  
NEEDED FOR PASSENGER  
& LIGHT TRUCK REPAIR**



**14-298  
Puncture Repair Tool Kit**

- Sturdy, blow-molded case keeps everything organized and get the carbide!
- Also Includes:

**RMA Wall Chart &  
XtraSeal Puncture Repair  
Guide/Catalog**



**ALSO  
INCLUDED**

**PUNCTURE REPAIR TOOL KIT  
CONTENTS**

Part Number	Description
14-315H	Inner Liner Scraper
14-303P	1/8" Stickle Back Probe
14-310A	Power-Awl
14-554	White Markall Paint Stick
14-305	Flexible Skiving Knife
14-314	Stitcher
14-301	Brass Brush
14-320	2 1/2" Buffing Wheel
14-330	Quick Change Adapter
14-345	Carbide Cutter – 3/16" Injury
14-346	Carbide Cutter – 1/4" Injury
14-333	Quick Change Adapter
14-334	Quick Change Adapter
14-204	Spiral Cement Probe

## MISCELLANEOUS TIRE REPAIR TOOLS



BRUSHES	
Part Number	Description
14-300	Retreaders' Brush
14-301	Small Brass Sidewall Tire Brush
14-301A	Large Brass Sidewall Tire Brush
14-309	Multi-Purpose Rim Brush
14-309R	Replacement Brush for 14-309

14-300

14-301

14-301A

14-309

14-309R

SKIVING KNIVES	
14-302	Curved, Pointed Skiving Knife
14-302R	Replacement Blades for 14-302 (Pack of 2)
14-305	Flexible Skiving Knife
14-306	Rigid, Tapered Skiving Knife
14-306A	Curved Skiving Knife



14-302

14-302R



14-305



14-306



14-306A



14-308

14-314

14-314A

14-314T



14-315

14-315H

14-315B

STITCHERS AND SCRAPERS	
Part Number	Description
14-308	Buffer - Stitcher
14-314	1/4" x 1 1/2" Wood Handle Stitcher
14-314A	1/4" x 2" Wood Handle Stitcher
14-314T	1/8" x 1 1/2" Plastic Handle Stitcher
14-314W	1 1/2" x 1 1/2" Wood Handle Stitcher
14-315	Blade Style Inner Liner Scraper
14-315B	Replacement Blade for 14-315
14-315H	Hoe Style Inner Liner Scraper

14-314W



14-552



14-553



14-555



14-551

14-554

CRAYONS AND PAINT STICKS				
Part Number	Description	Box Qty	Case Qty	
14-552	Yellow Crayon, 1/2" Hex	12	12	
14-553	White Crayon, 1/2" Hex	12	12	
14-555	Crayon Holder for 14-552 & 14-553	-	-	
14-551	Yellow Markall Paint Stick, 3/4" Round	12	12	
14-554	White Markall Paint Stick, 3/4" Round	12	12	
14-556	1X Premium Paint Stick, Yellow, 3/4" Round	12	12	
14-557	1X Premium Paint Stick, White, 3/4" Round	12	12	

14-552

14-553

14-555

14-551

14-554

14-556

14-557

TREAD DEPTH GAUGES	
Part Number	Description
17-607	Tread Depth Gauge
17-607C	Color Coded Tread Depth Gauge
17-607D	Digital Tread Depth Gauge
17-607T	Truck Tread Depth Gauge

17-607

17-607C

17-607T

17-607D



# TIRE INJURY PROBES



INJURY PROBES	
Part Number	Description
14-310	Power-Awl
14-310A	Power Awl with Injury Size Rings



SPIRAL CEMENT PROBES	
Part Number	Description
14-204	Pistol-Grip Spiral Cement Probe
14-204S	Pistol-Grip Spiral Cement Probe, Knurled
14-218	Die-Cast T-Handle Spiral Cement Probe
14-218H	Die-Cast Handle for 14-218
14-221	Heavy-Duty Composite Spiral Probe
14-304T	T-Handle Spiral Cement Probe, 7" probe
14-317P	Chrome T-Handle Spiral Probe



STICKLE BACK PROBES	
Part Number	Description
14-303P	1/8" Stickle Back Probe, 3 5/8" probe
14-303S	1/4" Stickle Back Probe, 4" probe
14-303L	1/4" Stickle Back Probe, 10" probe

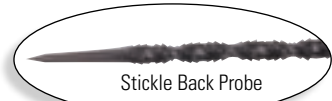
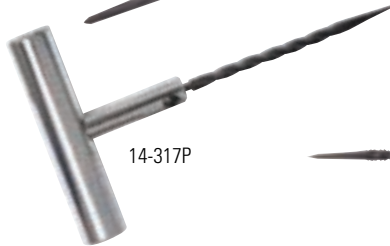

RASPS	
Part Number	Description
14-211	Pistol-Grip 2-Stage Rasp
14-220	Heavy Duty Composite Power Rasp
14-303	Carbide Power-Rasp
14-303B	Screwdriver Handle 2-Stage Rasp

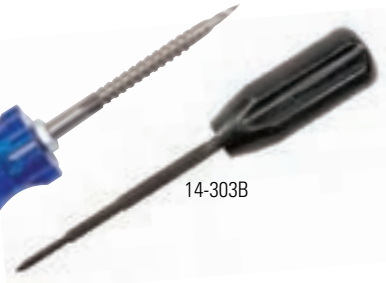
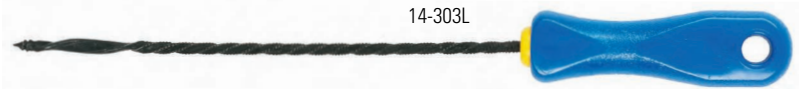

REPLACEMENT RASPS AND PROBES	
Part Number	Description
14-211R	2-Stage Rasp for 14-218H
14-218R	Spiral Cement Probe for 14-218H
14-303R	Carbide Rasp for 14-303 & 14-220
14-317S	Spiral Cement Probe for 14-317 & 14-221





## TIRE REPAIR TOOLS

A tire repair can only be successful if the technician is well equipped to do the job. For this reason, we offer the largest selection of quality **tire repair tools** in the industry today.



### SPLIT-EYE NEEDLE

Part Number	Description
14-216	Pistol-Grip Split-Eye Needle
14-217	Die-Cast T-Handle Split-Eye Needle
14-217H	Die-Cast Handle for 14-217
14-217S	Die-Cast Slide for 14-217
14-219	Heavy Duty Composite Insert Tool, Replaceable Needle
14-238	Pistol-Grip Split-Eye Needle, 5 1/2" Needle
14-307	Pistol-Grip Split-Eye Needle, Replaceable
14-317	Chrome T-Handle Split-Eye Needle

### 14-219 Heavy Duty Composite Insert Tool

- XL Pistol Grip Design, Weighted Handle with Metal Core
- Composite Plastic and Rubber Grip – Maxi-Effective
- Replaceable Needle



### OPEN-EYE NEEDLE

Part Number	Description
14-212	Pistol-Grip Open-Eye Needle
14-312T	Open-Eye Needle, 5 7/8" needle
14-312THD	Open-Eye Needle, 7 5/8" needle



### CLOSED-EYE NEEDLE

Part Number	Description
14-213	Pistol-Grip Closed-Eye Needle
14-313T	Closed-Eye Needle, 7 7/8" needle

### REPLACEMENT NEEDLES

Part Number	Description
14-212R	Open-Eye Needle for 14-217H
14-213R	Closed-Eye Needle for 14-217H
14-217R	Split-Eye Needle for 14-217H, Passenger
14-217TR	Split-Eye Needle for 14-217H, Truck
14-307R	Split-Eye Needle for 14-307, Passenger
14-307TR	Split-Eye Needle for 14-307, Truck
14-317R	Split-Eye Needle for 14-317, Passenger
14-317TR	Split-Eye Needle for 14-317, Truck

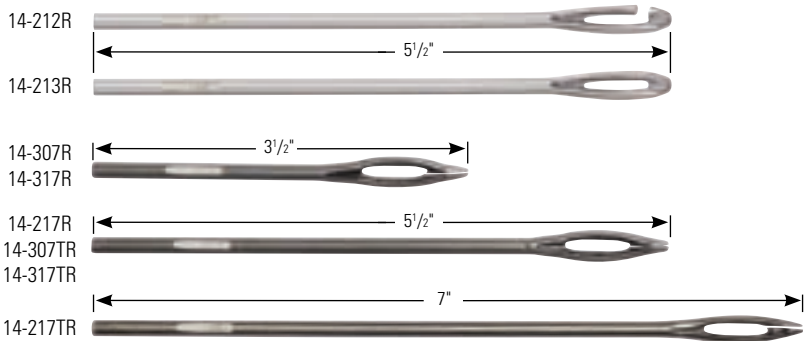

# PNEUMATICS & ACCESSORIES

Always wear eye protection when operating air tools.

Performing a quality tire repair begins with using the right tools. Whether you are performing a small puncture repair or a larger section repair, we make available a wide range of quality pneumatics and accessories to do the job right.

## 14-326K 1/2" Heavy Duty Reversible Air Drill

- Delivers High-Torque Performance at Low Speed
- 1/2" Key-Lock Chuck
- 1 Button Forward/Reverse Toggle Switch
- Dual Grip Side Handle with Vibration Dampening Handle Grip
- Whip Hose with Sound Reduction Exhaust Boot
- 800 RPM Free Speed



## 14-319DX Low Speed Air Buffer with Quick Disconnect

- Quick-Change Disconnect Adapter Chuck
- Safety Lock-Throttle with Variable Speed Control
- Adjustable Hang Tab
- Whip Hose with Sound Reduction Exhaust Boot
- 2500 RPM Free Speed



AIR TOOLS	
Part Number	Description
14-318	Mighty-Mite Variable Speed Buffer Kit: 1 ea. air buffer, 1 ea. 14-318H, 1 ea. 14-318R, 1 ea. 14-320, 1 ea. 14-324S
14-319	High Speed Buffer with 3/8" Jacobs; 20,000 rpm
14-319LSQ	Low Speed Buffer with Quick Change; 2,500 rpm
14-319LST	Low Speed Buffer with 3/8" Jacobs; 2,500 rpm
14-319DX	Low Speed Buffer with Quick Change; 2,500 rpm
14-319LS*	Low Speed Buffer with Quick Change; 2,500 rpm
14-325*	High Speed Buffer with 3/8" Jacobs; 20,000 rpm
14-326K	1/2" Reversible High-Speed Air Drill, 800 rpm
14-399	Air Powered Vacuum: one-piece vacuum, 3" (76mm) dust brush, 9" (228mm) crevice tool, 16" (406mm) hose



*\*All St. Louis pneumatic tools are covered by a 12-month warranty. Any tool in need of repair outside of this warranty period can be repaired for a nominal charge.*

AIR TOOL ACCESSORIES	
Part Number	Description
14-318H	24" x 3/8" Swivel Hose, 1/4" NPT
14-318R	In-Line Air Regulator, 1/4" NPT
14-318S	3/8" Barbed Swivel, 1/4" NPT
14-329	Exhaust Hose Kit, 1/4" NPT
14-760	Air Tool Oil, 32 oz.
15-5324	Premium Hybrid Whip Hose – 24"
15-5336	Premium Hybrid Whip Hose – 36"

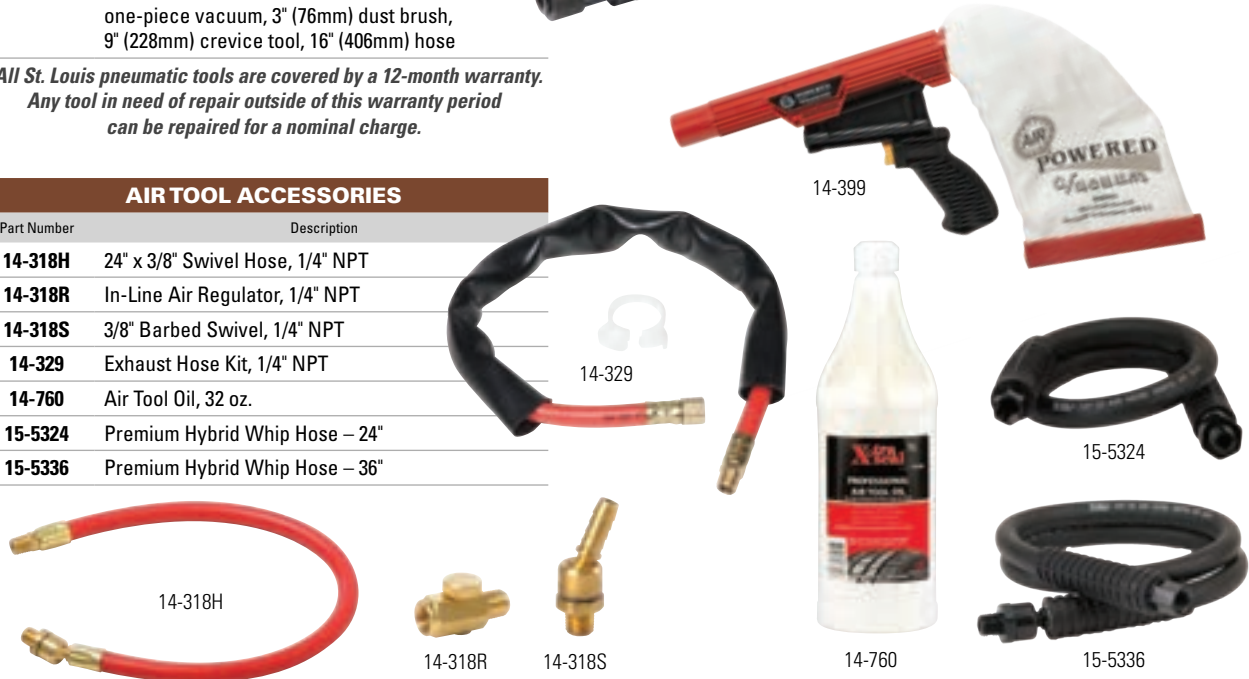

**ADAPTERS, CHUCKS & SAFETY GLASSES**

Part Number	Description
14-324	Long Arbor Adapter, 3/8" Threads
14-324C	1/8" Collet Adapter
14-324L	3/16" Collet Adapter
14-324S	Short Arbor Adapter, 3/8" Threads
14-327	3/8" Jacob's Chuck and Key, 3/8" NPT
14-328	3/8" Quick Change Chuck, 3/8" NPT
14-330	Short Quick Change Adapter, 3/8" Threads
14-331	Long Quick Change Adapter, 3/8" Threads
14-332	Quick Change Adapter for 1/8" (3.2mm) Shank
14-333	Quick Change Adapter for 3/16" (4.8mm) Shank
14-334	Quick Change Adapter for 1/4" (6.3mm) Shank
14-335	Quick Change Adapter for 5/16" (7.9mm) Shank
14-335-38	Quick Change Adapter for 3/8" (9.6mm) Shank
14-332W	L-Wrench for Quick Change Adapters
14-802	Safety Glasses



**CARBIDE BURRS FOR TIRE REPAIR**

*Maximum recommended operating speed = 1,200 rpm*

Part Number	Injury Size	Overall Length	Q.C. Adapter
14-340	1/8" (3mm) Injury	3"	14-332
14-345	3/16" (4.5mm) Injury	3"	14-333
14-346	1/4" (6mm) Injury	3"	14-334
14-347	5/16" (8mm) Injury	4"	14-335
14-348	3/8" (10mm) Injury	4 1/2"	14-335-38
14-349	1/2" (13mm) Injury	5"	14-335-38



**CARBIDE BURRS FOR SECTION REPAIR**

Part Number	Description	Q.C. Adapter
14-341	1/4" (6.3mm) Barrel Burr	14-334
14-342	1/2" (12.7mm) Ball Burr	14-334
14-343	1/8" (3.2mm) Pointed Burr	14-332
14-344	1/4" (6.3mm) Pointed Burr	14-334



**BUFFING WHEELS**

*Maximum recommended operating speed = 5,000 rpm*

Part Number	Description	Arbor Hole
14-320	2 1/2" Buffing Wheel, BC-1	3/8" (9.5mm)
14-320S	2" Buffing Wheel, BC-2	3/8" (9.5mm)
14-339	Back-to-Back 14-320 Wheels	3/8" (9.5mm)
14-359	2" Dome Buffing Wheel, 60 Grit	3/8" - 24 Thread
14-360	2" Black finishing cup, 60 Grit	3/8" (9.5mm)



Always wear eye protection when operating air tools.

**SILVER CARBIDE BUFFING WHEELS**

*Maximum recommended operating speed = 5,000 rpm*

Part Number	Description	Arbor Hole
<b>14-364</b>	2" Dome, 170 SSG (60 Grit)	3/8" – 24 Thread
<b>14-365</b>	2 1/2" Cup, 170 SSG (60 Grit)	3/8" (9.5mm)
<b>14-367</b>	2 1/2" Cup, 230 SSG (36 Grit)	3/8" (9.5mm)
<b>14-368</b>	4" Cup, 390 SSG (16 Grit)	3/4" (19mm)



**WIRE BRUSHES**

*Maximum recommended operating speed = 5,000 rpm*

Part Number	Description	Arbor Hole
<b>14-321</b>	2 1/2" Coarse Wire Wheel	3/8" (9.5mm)
<b>14-321S</b>	2" Coarse Wire Wheel	3/8" (9.5mm)
<b>14-322</b>	3" Soft Wire Wheel	3/8" (9.5mm)
<b>14-323</b>	2" Plastic Encased Wheel	3/8" (9.5mm)
<b>14-336</b>	3/8" Skiving Brush	1/4" Shank
<b>14-337</b>	1/2" Skiving Brush	1/4" Shank



**OXIDE STONES**

*For use in high speed grinders to grind steel cables.  
Maximum recommended operating speed = 20,000 rpm*

Part Number	Description	Shank Diameter
<b>14-353</b>	A-1 Large Pencil Stone, White	1/4" (6.3mm)
<b>14-353B</b>	A-1 Large Pencil Stone, Brown	1/4" (6.3mm)
<b>14-354</b>	A-15 Small Pencil Stone, White	1/4" (6.3mm)
<b>14-354B</b>	A-15 Small Pencil Stone, Brown	1/4" (6.3mm)
<b>14-355</b>	A-36 1 5/8" Lg. Mushroom Stone, White	1/4" (6.3mm)
<b>14-355B</b>	A-36 1 5/8" Lg. Mushroom Stone, Brown	1/4" (6.3mm)
<b>14-356</b>	A-37 1 1/4" Sm. Mushroom Stone, White	1/4" (6.3mm)
<b>14-356B</b>	A-37 1 1/4" Sm. Mushroom Stone, Brown	1/4" (6.3mm)

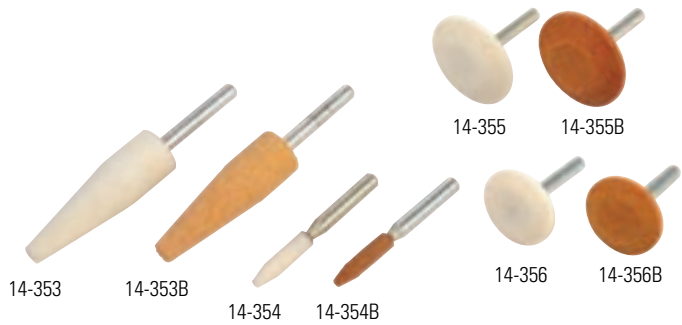

**ROUND FACED BUZZOUT WHEELS**

*Maximum recommended operating speed = 5,000 rpm*

Part Number	Diameter	Width	SSG (Grit)	Arbor Hole
<b>14-371</b>	1 3/8" (35mm) Rotor Saw		330 (16 Grit)	1/4" Shank
<b>14-373</b>	7/8" (22mm) Ball		390 (16 Grit)	1/4" Shank
<b>14-374</b>	2" (51mm)	1/4" (6mm)	230 (36 Grit)	3/8" – 24 Thread
<b>14-374A</b>	2" (51mm)	1/4" (6mm)	390 (16 Grit)	3/8" – 24 Thread
<b>14-375</b>	2" (51mm)	3/8" (9mm)	230 (36 Grit)	3/8" – 24 Thread
<b>14-375A</b>	2" (51mm)	3/8" (9mm)	390 (16 Grit)	3/8" – 24 Thread
<b>14-376</b>	2" (51mm)	1/2" (13mm)	230 (36 Grit)	3/8" – 24 Thread
<b>14-376A</b>	2" (51mm)	1/2" (13mm)	390 (16 Grit)	3/8" – 24 Thread
<b>14-377</b>	2" (51mm)	3/4" (19mm)	230 (36 Grit)	3/8" – 24 Thread
<b>14-377A</b>	2" (51mm)	3/4" (19mm)	390 (16 Grit)	3/8" – 24 Thread



Always wear eye protection when operating air tools.



## RASPS & CUPS

Maximum recommended operating speed = 5,000 rpm  
 Regritting available for rasps and cups – ask for details

### PIRANHA RASPS

Less expensive than standard round faced rasps

Part Number	Diameter	Width	SSG (Grit)	Arbor Hole
14-382	2" (51mm)	1/2" (13mm)	16 Grit	3/8"



### FLAT FACED RASPS

Part Number	Diameter	Width	SSG (Grit)	Arbor Hole
14-383	2" (51mm)	3/16" (5mm)	16 Grit	3/8" – 24 Thread
14-383A	2" (51mm)	3/16" (5mm)	36 Grit	3/8" – 24 Thread
14-384	2" (51mm)	1/4" (6mm)	16 Grit	3/8" – 24 Thread
14-384A	2" (51mm)	1/4" (6mm)	36 Grit	3/8" – 24 Thread

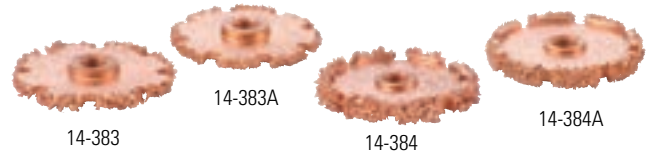

### ROUND FACED RASPS

Part Number	Diameter	Width	SSG (Grit)	Arbor Hole
14-385	2" (51mm)	1/2" (13mm)	16 Grit	3/8" – 24 Thread
14-385A	2" (51mm)	1/2" (13mm)	36 Grit	3/8" – 24 Thread
14-386	2" (51mm)	3/4" (19mm)	16 Grit	3/8" – 24 Thread
14-386A	2" (51mm)	3/4" (19mm)	36 Grit	3/8" – 24 Thread

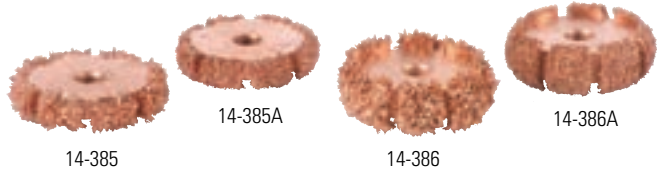

### PENCIL & TAPERED CONE RASPS

Part Number	Diameter	Width	SSG (Grit)	Arbor Hole
14-390	2 1/2" (64mm)	1/4" (6mm)	16 Grit	1/4" Shank
14-390A	2 1/2" (64mm)	1/4" (6mm)	36 Grit	1/4" Shank
14-393	2" (51mm)	3/4" (19mm)	16 Grit	3/8" – 24 Thread
14-393A	2" (51mm)	3/4" (19mm)	36 Grit	3/8" – 24 Thread
14-394	4" (102mm)	3/4" (19mm)	16 Grit	3/8" – 24 Thread
14-394A	4" (102mm)	3/4" (19mm)	36 Grit	3/8" – 24 Thread

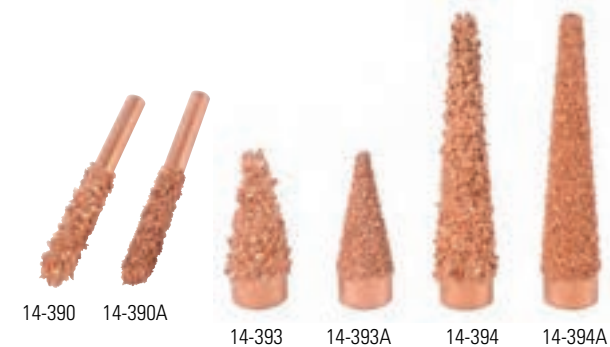

### CONTOUR CUPS

Part Number	Diameter	Width	SSG (Grit)	Arbor Hole
14-396	3" (76mm)	1" (25mm)	16 Grit	3/8"
14-396A	3" (76mm)	1" (25mm)	36 Grit	3/8"
14-397	3" (76mm)	1 1/2" (38mm)	36 Grit	3/8"
14-397A	3" (76mm)	1 1/2" (38mm)	60 Grit	3/8"
14-398	4" (102mm)	1 1/2" (38mm)	36 Grit	1/2"
14-398A	4" (102mm)	1 1/2" (38mm)	60 Grit	1/2"



### ROTARY GOUGES

Part Number	Description	Arbor Hole	Box Qty
14-401	3/4" Micro	3/8"-24 Thread	4
14-402	1 1/4" Mini	3/8"	3
14-404	2" Thin Walled	3/8"	2
14-405	2" Thin Walled, Notched	3/8"	2
14-408	2" Thin Walled	1/2"	2
14-411	2" Heavy Walled, Notched	1/2"	1
14-412	1/2" to 3/8" Reducer Washer		



Always wear eye protection when operating air tools.

## WHEEL SERVICE TOOLS

We make available a large selection of specialty tire & wheel service tools. The most popular tools available in one place.



### M7 Air Impact Wrenches

- Compact Size (4 3/8" length) and Lightweight (under 3.5 lb.) for All Day Use
- Deliver 500 ft-lb Max Torque
- Quiet 85 db Operation
- 4.0 CFM Air Consumption
- 3/8" Air Hose Fittings, 1/2" Drive
- 14-252 Features a 2" Anvil for Using Flip Sockets



**14-251**  
1/2" Drive  
Mini Impact Wrench

10,000 rpm



**14-252**  
1/2" Drive  
Mini Impact  
Wrench with 2" Anvil

9,000 rpm

## WHEEL SERVICE KITS

### 9-PIECE TORQUE MASTER KIT

Part Number	Description	
<b>14-810</b>	<b>9-Piece Torque Master Kit (14-811 – 14-819)</b>	
<b>14-811</b>	13/16" 100 ft-lbs.	Brown
<b>14-812</b>	21mm 80 ft-lbs.	Orange
<b>14-813</b>	19mm 100 ft-lbs.	Gray
<b>14-814</b>	21mm 60 ft-lbs.	Black
<b>14-815</b>	19mm 80 ft-lbs.	Blue
<b>14-816</b>	19mm 65 ft-lbs.	Yellow
<b>14-817</b>	17mm 80 ft-lbs.	Red
<b>14-818</b>	17mm 55 ft-lbs.	Green
<b>14-819</b>	7/8" 120 ft-lbs.	White
<b>14-819Q</b>	7/8" 140 ft-lbs.	Aqua

### 14-810 9-Piece Torque Master Kit

The 9-piece torque master kit will tighten wheel nuts to the correct torque, the first time, every time on most makes and models of foreign and domestic cars and light trucks. These tools are designed for use with a 1/2" drive impact wrench and comes in a wall mountable carrying case with wall chart.



14-810

### 5-PIECE TORQUE EXTENSION KIT

Part Number	Description	
<b>14-820</b>	<b>5-Piece Torque Extension Kit (14-821 – 14-825)</b>	
<b>14-821</b>	100 ft-lbs.	Gray
<b>14-822</b>	80 ft-lbs.	Blue
<b>14-823</b>	65 ft-lbs.	Yellow
<b>14-824</b>	120 ft-lbs.	White
<b>14-825</b>	140 ft-lbs.	Aqua



14-820

### 14-820 5-Piece Torque Extension Kit

The 1/2" Drive Wheel Torque Extension Kit will torque wheel nuts on most foreign and domestic cars and light trucks to the correct torque, the first time, every time, with your thin wall or regular lug nut sockets. Since more vehicles every year have tight tolerances around the wheel nuts, this kit will help eliminate damage to wheels when torquing the wheel nuts. This 5-piece kit includes a wall chart and a custom case.

### FLIP SOCKET

Part Number	Size	Description
<b>14-845</b>	17mm – 19mm	Thin Walled
<b>14-845A</b>	17mm – 19mm	Extra Thin Walled
<b>14-846</b>	3/4" – 13/16"	Thin Walled
<b>14-846A</b>	3/4" – 13/16"	Extra Thin Walled
<b>14-847</b>	19mm – 21mm	Thin Walled
<b>14-847A</b>	19mm – 21mm	Extra Thin Walled
<b>14-848</b>	7/8" – 15/16"	Thin Walled



# SOCKETS & WHEEL SERVICE KITS

## Specialty Alloy Wheel Impact Socket Set



- 17 EXTRA-THIN WALL DEEP-IMPACT SOCKETS with Poly Rim Protectors
- 1/2" DRIVE with 6-Point Hex Opening – SAE & Metric Sizes
- RAD-VTX™ High Strength, High Torque, Less Wear
- HD CRMO Color-Coded with Dual-HD Sizing Laser & Stamp
- BMC Poly Storage Case



1/2" DRIVE • X-TRA THIN WALL IMPACT SOCKETS		
Part Number	Description	Size
<b>7 UNIT SAE &amp; METRIC X-TRA THIN WALL DEEP-IMPACT (18-666 to 18-621)</b>		
18-666	SAE GREEN	13/16"
18-667	SAE DARK GREEN	7/8"
18-669	SAE NICKEL	1"
18-670	SAE BLACK	1-1/16"
18-617	MM BLUE	17mm
18-619	MM GOLD	19mm
18-621	MM RED	21mm
<b>3 UNIT METRIC X-TRA THIN WALL DEEP-IMPACT (18-617, 18-619, 18-621)</b>		

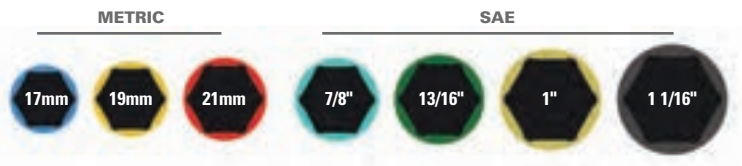

1/2" DRIVE • STANDARD-LENGTH SAE IMPACT SOCKETS		
Part Number	Description	Size
<b>13 UNIT SAE STANDARD-LENGTH Socket Set</b>		
18-031	Standard Length – SAE	7/16"
18-360	Standard Length – SAE	1/2"
18-361	Standard Length – SAE	9/16"
18-362	Standard Length – SAE	5/8"
18-364	Standard Length – SAE	11/16"
18-365	Standard Length – SAE	3/4"
18-366	Standard Length – SAE	13/16"
18-367	Standard Length – SAE	7/8"
18-368	Standard Length – SAE	15/16"
18-369	Standard Length – SAE	1"
18-370	Standard Length – SAE	1-1/16"
18-371	Standard Length – SAE	1-1/8"
18-373	Standard Length – SAE	1-1/4"

### 13 Unit SAE Standard-Length Impact Socket Set – BMC



18-031  
Standard-Length SAE Socket Set

**1/2" DRIVE • STANDARD-LENGTH**

Part Number	Description	Size
<b>18-032</b>	<b>14 UNIT METRIC STANDARD-LENGTH SOCKETS</b>	
18-310	Standard Length – MM	10mm
18-311	Standard Length – MM	11mm
18-312	Standard Length – MM	12mm
18-313	Standard Length – MM	13mm
18-314	Standard Length – MM	14mm
18-315	Standard Length – MM	15mm
18-316	Standard Length – MM	16mm
18-317	Standard Length – MM	17mm
18-318	Standard Length – MM	18mm
18-319	Standard Length – MM	19mm
18-321	Standard Length – MM	21mm
18-322	Standard Length – MM	22mm
18-326	Standard Length – MM	26mm
18-327	Standard Length – MM	27mm

**1/2" DRIVE • DEEP-LENGTH**

<b>18-033</b>	<b>11 UNIT SAE &amp; METRIC DEEP-LENGTH Socket Set</b>	
18-465	Deep Length – SAE	3/4"
18-466	Deep Length – SAE	13/16"
18-467	Deep Length – SAE	7/8"
18-469	Deep Length – SAE	1"
18-470	Deep Length – SAE	1-1/16"
18-417	Deep Length – MM	17mm
18-419	Deep Length – MM	19mm
18-421	Deep Length – MM	21mm
18-422	Deep Length – MM	22mm
18-423	Deep Length – MM	23mm
18-101	3" Drive Extension – ≥ Friction Ball	3"

**1/2" DRIVE • DEEP-LENGTH**

<b>18-034</b>	<b>13 UNIT SAE DEEP-LENGTH Socket Set</b>	
18-460	Deep Length – SAE	7/16"
18-461	Deep Length – SAE	1/2"
18-462	Deep Length – SAE	9/16"
18-463	Deep Length – SAE	5/8"
18-464	Deep Length – SAE	11/16"
18-465	Deep Length – SAE	3/4"
18-466	Deep Length – SAE	13/16"
18-467	Deep Length – SAE	7/8"
18-468	Deep Length – SAE	15/16"
18-469	Deep Length – SAE	1"
18-470	Deep Length – SAE	1-1/16"
18-471	Deep Length – SAE	1-1/8"
18-473	Deep Length – SAE	1-1/4"

**METRIC Standard-Length Impact Socket Set – BMC**



18-032  
Standard-Length METRIC Socket Set

**SAE & METRIC Deep-Length Impact Socket Set – BMC**



18-033  
Deep-Length SAE & METRIC Socket Set

**SAE Deep-Length Impact Socket Set – BMC**



18-034  
Deep-Length SAE Socket Set



**1/2" DRIVE • DEEP-LENGTH**

Part Number	Description	Size
<b>18-035</b>	<b>14 UNIT METRIC DEEP-LENGTH SOCKETS</b>	
<b>18-410</b>	Deep Length – MM	10mm
<b>18-411</b>	Deep Length – MM	11mm
<b>18-412</b>	Deep Length – MM	12mm
<b>18-413</b>	Deep Length – MM	13mm
<b>18-414</b>	Deep Length – MM	14mm
<b>18-415</b>	Deep Length – MM	15mm
<b>18-416</b>	Deep Length – MM	16mm
<b>18-417</b>	Deep Length – MM	17mm
<b>18-418</b>	Deep Length – MM	18mm
<b>18-419</b>	Deep Length – MM	19mm
<b>18-421</b>	Deep Length – MM	21mm
<b>18-422</b>	Deep Length – MM	22mm
<b>18-426</b>	Deep Length – MM	26mm
<b>18-427</b>	Deep Length – MM	27mm

**METRIC Deep-Length Impact Socket Set – BMC**



18-035  
Deep-Length METRIC Socket Set

**1/2" DRIVE • EXTRA-THIN-WALL DEEP-LENGTH**

Part Number	Description	Size
<b>18-036</b>	<b>11 UNIT SAE &amp; METRIC XTRA-THIN-WALL DEEP-LENGTH Socket Set</b>	
<b>18-565</b>	Xtra Thin Wall Deep Length – SAE	3/4"
<b>18-566</b>	Xtra Thin Wall Deep Length – SAE	13/16"
<b>18-567</b>	Xtra Thin Wall Deep Length – SAE	7/8"
<b>18-569</b>	Xtra Thin Wall Deep Length – SAE	1"
<b>18-570</b>	Xtra Thin Wall Deep Length – SAE	1-1/16"
<b>18-517</b>	Xtra Thin Wall Deep Length – MM	17mm
<b>18-519</b>	Xtra Thin Wall Deep Length – MM	19mm
<b>18-521</b>	Xtra Thin Wall Deep Length – MM	21mm
<b>18-522</b>	Xtra Thin Wall Deep Length – MM	22mm
<b>18-523</b>	Xtra Thin Wall Deep Length – MM	23mm
<b>18-101</b>	3" Drive Extension – Friction Ball	3"

**SAE & METRIC Extra-Thin-Wall Deep-Length Impact Socket Set – BMC**



18-036  
Extra-Thin Wall Deep-Length SAE & Metric Socket Set

**3/4" DRIVE • WHEEL SERVICE SET**

Part Number	Description	Size
<b>18-061</b>	<b>5 UNIT SAE &amp; METRIC Wheel Service Set</b>	
<b>18-766SQ</b>	Standard Length Square – SAE	13/16"
<b>18-733</b>	Deep Length – MM	33mm
<b>18-771</b>	Deep Length – SAE	1-1/16"
<b>18-773</b>	Deep Length – SAE	1-1/4"
<b>18-777</b>	Deep Length – SAE	1-1/2"

**SAE & METRIC Wheel Service Set – BMC**



18-061  
SAE & METRIC Wheel Service Set

**1" DRIVE • WHEEL SERVICE SET**

Part Number	Description	Size
<b>18-081</b>	<b>10 UNIT SAE &amp; METRIC Wheel Service Set</b>	
<b>18-866SQ</b>	Standard Length Square – SAE	13/16" SQ
<b>18-868SQ</b>	Standard Length Square – SAE	15/16" SQ
<b>18-833</b>	Deep Length – MM	33mm
<b>18-869</b>	Deep Length – SAE	1"
<b>18-872</b>	Deep Length – SAE	1-3/16"
<b>18-881</b>	Deep Length – SAE	1-3/4"
<b>18-803</b>	Xtra Thin Wall Deep Length – SAE	1-1/16"
<b>18-804</b>	Xtra Thin Wall Deep Length – SAE	1-1/8"
<b>18-805</b>	Xtra Thin Wall Deep Length – SAE	1-1/4"
<b>18-141</b>	Deep Length Combination Budd Socket – SAE	1 1/2" x 13/16" SQ

**DRIVE EXTENSIONS**

Part Number	Description	Drive
<b>18-101</b>	3" Drive Extension – Friction Ball	1/2"
<b>18-102</b>	5" Drive Extension – Friction Ball	1/2"
<b>18-120</b>	6" Drive Extension – Friction Ball	1"
<b>18-130</b>	Universal Joint 1/2" x 1/2" – Friction Ball	1/2"
<b>18-131</b>	Universal Joint 3/4" x 3/4" – Friction Ball	3/4"
<b>18-132</b>	Universal Joint 1" x 1" – Friction Ball	1"
<b>18-140</b>	41mm x 21mm Deep Combination Budd Socket	1"
<b>18-141</b>	1 1/2" x 12/16" Deep Combination Budd Socket	1"

**Deluxe Hubcap & Wheel Lock Removal Kit**

The Deluxe Hubcap and Wheel Lock Removal Kit safely removes and replaces GM, Ford, and Chrysler wire wheel hubcap locks on 1978 or newer vehicles. Also removes factory and most aftermarket locking lug nuts. Includes instructions and is packaged in a custom carrying case.

**HUBCAP AND WHEEL REMOVAL KIT**

Part Number	Description
<b>14-830</b>	Deluxe Hubcap and Wheel Lock Removal Kit



14-830

**Sockets for Lug Nut Removal**

For the removal of lug nuts that are damaged/rounded because of unsuccessful removal, rust or other damage. The twist socket has a fluted design which gives the socket a tight grip to remove the most difficult lug nuts with easy removal of the lug nut from the socket. Works with a 1/2" impact wrench or breaker bar for service calls.

**SOCKETS FOR LUG NUT REMOVAL**

Part Number	Description
<b>14-835</b>	<b>Twist Socket Lug Nut Removal System</b> Two dual-sided sockets and extractor punch Use for 3/4", 19mm, 13/16", 21mm lugnuts
<b>14-840</b>	Dual-Sided Twist Socket Lug Nut Remover Use for 3/4", 19mm, 13/16", 21mm lugnuts
<b>14-840A</b>	400-12 Replacement Socket for 14-830



**NOTE:** • Socket with 6 flute design is for removing regular lugnuts  
• Socket with 12 flute design is for removing locking lugnuts

**SAE & METRIC Wheel Service Set – BMC**



18-081  
10 Unit SAE & METRIC Wheel Service Set



18-101 18-102 18-120

18-130 18-131 18-132



18-140 18-141

## TOOL & SUPPLY ORGANIZERS



**14-600**  
**Tire Repair Wall Cabinet**

- Designed for a tire repair supply product assortment
- 9" deep x 20" wide x 23" tall, 35 lbs., metal build suitable for wall mount
- Multiple shelves, 1 pull-out drawer, and 1 oversized bin-space drawer



**14-607**  
**TPMS Wall Cabinet**

- Designed for a TPMS product assortment
- 11.5" deep x 22" wide x 28.5" tall, metal build suitable for wall mount
- Locking door, multiple shelves, 1 small pull-out drawer, 3 pull out bin-space drawers offering 36 spaces for service kit organization



**14-652BOX**  
**Tool Box**



**14-614**  
**Rolling Cabinet**

- 500 lb. Load Capacity
- Extending lid with automatic gas shocks
- 5" Industrial casters
- Ball bearing cabinet glides
- Lid and drawer locking system with keys
- 2 – 3" drawers, 1 – 4" drawer, 1 – 5" drawer
- 40" tall  
39" wide (with handle)  
22" deep

## TIRE MOUNT/DEMOUNT TOOLS

Ken-Tool™ offers a complete line of tire changing tools, bead breaking tools, lug wrenches, rim service tools, and specialty tools. For your convenience we offer the most popular tools used in the industry today.



Any Ken-Tool™ item not listed is available by special order. Ask for details.

Any Ken-Tool™ item not listed is available by special order. Ask for details.

### Wrenches

WRENCHES						
Part Number	EDP No.	Description	Socket Sizes	Length	Stock	Weight
14-T57	35657	Professional Gold 4-Way	3/4", 13/16", 7/8", 15/16"	23" (58.4cm)	5/8" (16mm)	4 3/4 lbs. (2.0kg)
14-T95	35695	Heavy Duty Truck 4-Way	1 1/16", 1 1/4", 1 1/2", 13/16" sq	27 1/2" (69.9cm)	1" (25mm)	13 3/4 lbs. (6.2kg)
14-TX9	30609	SAE and Metric Cap Nut	1 1/2" (38mm)			.4 lbs. (.1kg)

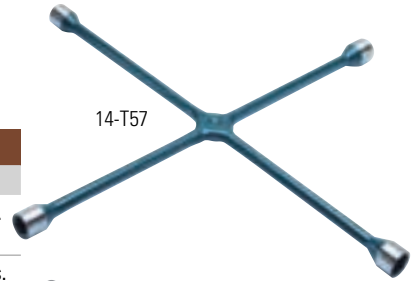

14-T57

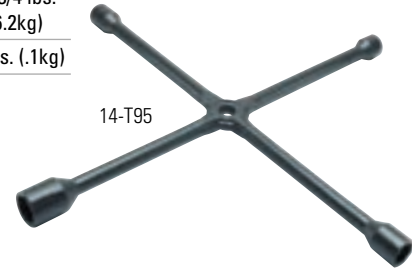

14-T95



14-TX9

### Bead Breaking Tools & Hammers

BEAD BREAKING TOOLS				
Part Number	EDP No.	Description	Length	Weight
14-T11E	35329	Wood Handled Wedge	30" (76.2cm)	8 1/2 lbs.
14-TG11D	35427	Fiberglass Handled Wedge	18" (45.7cm)	4 3/4 lbs.
14-TG11E	35429	Fiberglass Handled Wedge	32" (81.3cm)	8 1/2 lbs.
14-T24B	35924	Economy Impact Bead Breaker	46" - 72" (117.0cm - 183.0cm)	13.5 lbs. (6.1kg)
14-T26B	35926	Heavy Duty Impact Bead Breaker	50" - 80" (127.0cm - 203.2cm)	23 lbs. (10.4kg)



14-T11E



14-TG11D



14-TG11E



14-T24B



14-T26B

HAMMER HANDLES				
Part Number	EDP No.	Description	Length	Weight
14-T11EH	35129	Hickory Handle	30" (76.2cm)	1 1/4 lbs.
14-TG11EH	35229	Fiberglass Handle	32" (81cm)	2 1/4 lbs.

TIRE HAMMERS WITH FIBERGLASS HANDLE				
Part Number	EDP No.	Description	Length	Weight
14-TG35	35423	Head Wt. 4 3/4 lbs. (2.2kg)	18" (45.7cm)	7 lbs. (3.2kg)
14-T34RH	35105	Rubber Head for TG35		1 lb.



14-TG35



## Lock Ring Tools

These tools are designed to remove lock rings on most trucks on the road today. A must-have for anyone mounting or demounting multi-piece rims.



Any Ken-Tool™ item not listed is available by special order. Ask for details.

TRUCK LOCK RING TOOLS				
Part Number	EDP No.	Length	Stock	Weight
<b>14-T48A</b>	34648	<b>HEAVY DUTY LOCK RING TOOL</b> Use for multi-piece wheels, especially hub type. 37" (94cm)	3/4" (19mm)	4.6 lbs. (2.1kg)



## Wheel Cover Puller

Removes wheel covers quickly and easily without gouging or scratching them. Rubber head T11RH prevents damage to hub cap and is replaceable.

WHEEL COVER PULLER				
Part Number	EDP No.	Length	Stock	Weight
<b>14-T68</b>	31568	14" (36cm)	7/16" (11.1mm)	1 1/4 lbs. (.6kg)



## Tubeless Tire Irons

Use on standard and large truck tires, including industrial, farm, buses, and tractors. Use in pairs.

TUBELESS TIRE IRONS				
Part Number	EDP No.	Length	Stock	Weight
<b>14-T45A</b>	34645	37" (94.0cm)	3/4" (19mm)	4 1/2 lbs. (2.0kg)
<b>14-T45A-2000K</b>	34644	37" (94.0cm)	3/4" (19mm)	5 lbs. (2.2kg)
<b>14-T45HD</b>	34647	41" (104.1cm)	7/8" (22mm)	7 lbs. (3.2kg)
<b>14-T46A</b>	34747	36" (91.4cm)	3/4" (19mm)	4 1/2 lbs. (2.0kg)



## Tire Mount/Demount Tools

These irons are designed for fast and efficient tire changing. Use the 18" and 24" spoons to mount or demount passenger car, motorcycle, ATV, and light truck tires. The 30" spoons provide enough strength and leverage to work on large truck, bus, off road vehicle, tractor and aircraft tires. Use in pairs.

STRAIGHT TIRE SPOONS				
Part Number	EDP No.	Length	Stock	Weight
<b>14-T19</b>	32119	24" (61.0cm)	11/16" (17.5mm)	2 1/2 lbs. (1. kg)
<b>14-T19A</b>	33219	30" (76.2cm)	11/16" (17.5mm)	3 lbs. (1.4kg)

CURVED TIRE SPOONS				
Part Number	EDP No.	Length	Stock	Weight
<b>14-T2X</b>	32102	18" (45.7cm)	11/16" (17.5mm)	1 3/4 lbs. (.3kg)
<b>14-T20</b>	32120	24" (61.0cm)	11/16" (17.5mm)	2 1/4 lbs. (1.0kg)
<b>14-T20A</b>	33220	30" (76.2cm)	11/16" (17.5mm)	3 lbs. (1.4kg)

DROP-CENTER TIRE SPOONS				
Part Number	EDP No.	Length	Stock	Weight
<b>14-T21F</b>	34121	24" (61.0cm)	11/16" (17.5mm)	2 1/2 lbs. (1.1kg)
<b>14-T21R</b>	32121	18" (45.7cm)	11/16" (17.5mm)	1 3/4 lbs. (.3kg)

SMALL TIRE TOOLS				
Part Number	EDP No.	Length	Stock	Weight
<b>14-T6A</b>	32106	16 1/2" (42cm)	5/8" (16mm)	1 1/2 lbs. (.7kg)
<b>14-T9A</b>	32109	9" (23cm)	7/16" (11mm)	.4 lbs. (.16kg)



**14-35440**

**BLUE COBRA® Truck Tire Demount Tool**

Quickly demount nearly any 22.5" and 24.5" tubeless truck tire up to a 13" wide wheel. Ergonomic shaped steel handle with no-slip grip for optimum leverage while reducing back injuries. Solid steel Cobra head is press-fit into the steel handle — no fasteners to loosen or fall out. Allows demounting of the tire without lifting the entire wheel and tire off the ground — reduces back injuries. Aluminum bead support to grab the top bead of Super Single and Super Wide tires. 2 heavy-duty nylon rollers are easily replaced when worn, kit No. 35441 includes two rollers and two roll pins.



14-35440  
16 lbs. (7.3 kg)

**14-34549**

**4 Piece Dual Wheel Separator Kit**

Makes removing stuck or frozen dual steel wheels quick and easy. Ideal for use on nearly any truck, bus, van or trailer that has dual steel wheels. Component parts available.

- Innovative "One-piece" pusher won't fall apart during use
- Pusher is ball bearing-driven for near-zero turning resistance
- Pusher is heat treated for long-lasting strength and durability
- Forcing screw and pullers have powerful 1-1/8" diameter x 11 threads for years of reliable service
- Includes two pullers to cover large truck, trailer and smaller light truck dual wheel applications
- Components have black oxide or bright nickel plating finish for rust and corrosion resistance
- Use with air or electric impact wrench
- Components are laser-etched for easy identification
- Comes in a sturdy, compact, easy to store case; 6.5" x 9.5" x 2.5", 5.3 lbs.
- Proudly made in USA
- Limited lifetime warranty



14-34549  
5.3 lbs. (2.4 kg)



**14-916**

**Little Buddy Tire Bead Breaker**

Loosens tire bead from rim with leverage. Excellent for working on tire without removing the whole wheel from tractor. Will handle 38" and 42" 14-ply farm tractor and backhoe tires with drop center rims to small ATV and lawn mower tires. Operates with air ratchet.



14-916  
10" length  
12 lbs.



**WARNING**

**HAMMERS**

Always wear safety goggles when using striking or struck tools. Never use one hammer to strike another hammer. Never use a striking tool with loose or damaged handle. Discard any striking or struck tool if tool shows dents, cracks, chips or mushrooming.

**WARNING**

**STRUCK TOOLS, BEAD BREAKERS AND WEDGES**

Striking and struck tools can break or chip. Chipped or mushroomed ends can fragment. Wear safety goggles. Replace damaged tools.

## MOUNTING RINGS & ACCESSORIES

Many earthmover, grader, agricultural, and industrial tires require the use of O-rings or L-rings to achieve an air-tight seal. We offer only the highest quality products to meet this need.

### O-Rings for Earthmovers

- High quality polysoprene rubber
- Manufactured to OEM specifications

### L-Rings for Earthmovers

- Creates an air seal where the bead and rim seat are not completely compatible
- Not a cure for damaged beads or damaged wheels and rims. Caution should be used during fitments. Do not install where a broken bead is suspected.



O-RINGS				
Part Number	Tire Type	Rod Diameter	Rim Size	Bag Qty
16-120JM	Highway (JM)	0.250"	20"	2
16-122JM	Highway (JM)	0.250"	22"	2
16-124JM	Highway (JM)	0.250"	24"	2
16-1220TG	Grader	0.250"	20"	2
16-1224TG	Grader	0.250"	24"	2
16-125T	Earthmover	0.250"	25"	2
16-1325T	Earthmover	0.375"	25"	2
16-1329T	Earthmover	0.375"	29"	2
16-1332T	Earthmover	0.375"	32"	2
16-1333T	Earthmover	0.375"	33"	2
16-1335T	Earthmover	0.375"	35"	2
16-1345T	Earthmover	0.375"	45"	2
16-1349T	Earthmover	0.375"	49"	2
16-1451T	Earthmover	0.500"	51"	2
16-1457T	Earthmover	0.500"	57"	2

L-RINGS		
Part Number	Rim Size	Bag Qty
16-225	25"	2
16-229	29"	2
16-233	33"	2
16-235	35"	2
16-239	39"	2
16-245	45"	2
16-249	49"	2
16-251	51"	2
16-257	57"	2
16-263	63"	2

### "Donut-Style" Mounting Rings

Donut-style mounting rings are a simple, yet effective mounting device that fits over the rim between the bead and rim flange creating a seal. As the tire expands, the mounting ring slides out over the rim allowing the beads to fully seat.

"DONUT STYLE" MOUNTING RINGS		
Part Number	Description	Diameter
14-990	For 13" Rims	1 3/4"
14-991	For 14" Rims	1 3/4"
14-992	For 16" - 17" Rims	1 1/8"
14-993	For 19.5" Rims	1 1/8"
14-994	For 22.5" - 24.5" Rims	1 1/8"
14-995	For 15" Rims	1 3/4"
14-996	For 16" Rims	1 3/4"
14-997	For 17" Rims	1 3/4"
14-998	For 18" Rims	1 3/4"
14-999	For 20" Rims	1 3/4"



**NOTE:** O.S.H.A. regulations require that service personnel use a clip-on air chuck with an inline inflater at a recommended distance that keeps the employee out of the trajectory of the tire and rim. After beads are seated, put tire and rim into approved inflation cage and continue to inflate to prescribed air pressure.



**14-CH5  
Cheetah Bead Seater**

The 5-gallon Cheetah Bead Seater makes seating the most difficult bead not only safe but simple, fast and economical. As the most popular bead seater model, the CH-5 has an ASME certified tank designed for commercial use on all tires, ATV to 24.5" truck tires, and is now available in lighter weight aluminum. The optional Magnum Barrel I is helpful in seating the beads on larger diameter wheels due to a wider distribution of the air blast.



**14-980  
Protectors for Aluminum Wheels**

Wheel protectors prevent wheel surfaces from being scarred and damaged by tools and other objects. These protectors are made from almost unbreakable polymer compound and are imprinted with torque sequences.

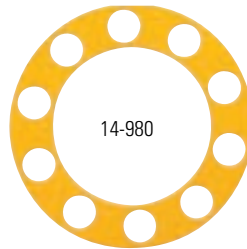

**14-986  
Zafety Lug Lock™**

This new and innovative product is setting a new standard for road safety in North America! Other products let you know when a lug nut has loosened but do nothing to ensure that the lug nuts remain torqued properly.

Zafety Lug Lock™ is a revolutionary design that incorporates the resistance between two nuts to minimize their ability to rotate, essentially locking them in place!

- Significantly reduces possibility of wheel separation resulting in personal injury, loss of life, property damage, and hefty fines
- Reduces inspection time, resulting in less downtime for vehicles and drivers
- Provides a clear, visual check
- Flexible, easy to install and remove, and re-usable
- Laboratory tested in severe vibration conditions from -40°F to +122°F (-40°C to +50°C)
- Fits 33mm lug nuts on 10-stud piloted wheels with 3.5" stud spacing



**19-231  
New/Used Tire Labels**

- Roll of 250 labels
- 2.5" x 6" labels





## WHEEL SERVICE

WHEEL WEIGHT TOOLS	
Part Number	Description
14-900	Premium Universal Wheel Weight Tool
14-900-1	Replacement Cap for 14-900
14-901	Premium Wheel Weight Hammer
14-901-1	Replacement Cap for 14-901
14-901-2	Replacement Hook for 14-901
14-902	Wheel Weight Remover
14-902-1	Replacement Cap for 14-902
14-902-2	Replacement Hook for 14-902
14-904	Wheel Weight Pliers
14-905	Wheel Weight Pliers
14-906	Heavy-Duty Wheel Weight Pliers
14-907	No-Mar Wheel Weight Pliers for Aluminum Rims
14-907R	Replacement Cap for 14-907
14-909	Stick on Wheel Weight Remover

### 14-900 Premium Universal Wheel Weight Tool

- The only tool that can remove ALL wheel weights, including stubborn "clip only" style weights, fast and easy without pinching fingers.
- Replacement parts available so you never have to buy another wheel weight tool again.
- Made in USA



14-900



14-901-1  
Replacement Cap

14-901-2  
Replacement Hook

14-901

14-902

14-904

14-905

14-906

14-907

14-907R  
Replacement Cap

14-909

### WHEEL BALANCER, CONES & SPACERS

Part Number	Description
14-94725-40	40mm Cone; 3.375" - 5.25" Range
14-94730-40	40mm Cone; 3.375" - 5.88" Range
14-94735-40	40mm Cone; 5.03" - 6.88" Range
14-94750-40	40mm Wheel Balancer Spacer/Backing Plate



14-94750-40

### 40mm CONES AND SPACERS FIT

Accuturn	1200, 1250, 1400, 1500, 1550, 1650, 1850, 5100 & 5600 (Serial 51-0623 to 51-1457)
Bear	80-100, 80-303
Beissbarth	All Models
CEMB	Truck Balancers Since June 2000
Coats	With Optional 40mm Shaft
ALL Models On	FMC, Hofmann, Hunter, John Bean, Kwik-Way, Performance, Phoenix CB-113

### WHEEL BALANCER ACCESSORIES

14-936	Manual Hub Nut for Coats Wheel Balancers for Coarse Thread Shaft 28.5mm
14-939	Rim Width Caliper

14-936



14-939



**CheckMate™  
Glass Blasting Beads**

CheckMate Glass blasting beads uniform smooth finish remove paint, rust and corrosion – creating a clean, uniform mating surface.

- They produce a smoother, brighter finish than angular abrasives
- Leaves no embedded contaminants or residue
- Reusable and environmentally friendly

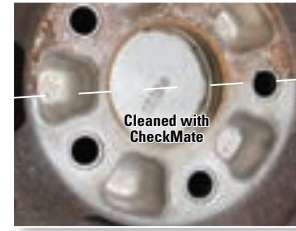
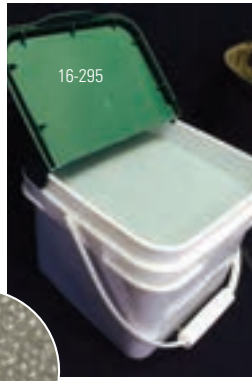

**CHECKMATE BEADS & BLASTING GUN**

Part Number	Description
16-295	CheckMate Blasting Beads, 400 oz. Bucket
16-299	Blasting Gun

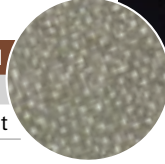

Counteract balances for the complete life of the tire by readjusting the balanced position as required. Benefits of keeping the entire wheel assembly in balance include increase tread life, increased fuel economy and eliminates wheel vibration.



**Counteract Balancing Beads**

- Easy to use, bag-in-bag packaging
- Will not clump due to moisture
- Will not interfere with tire repair (remove before beginning repair)
- Use with tubeless or tube-type tires

**COUNTERACT BALANCING BEADS**

Part Number	Size	Case Qty
16-301	1 oz. Counteract	40
16-302	2 oz. Counteract	32
16-303	3 oz. Counteract	24
16-304	4 oz. Counteract	92
16-305	5 oz. Counteract	76
16-306	6 oz. Counteract	64
16-308	8 oz. Counteract	52
16-310	10 oz. Counteract	40
16-312	12 oz. Counteract	36
16-314	14 oz. Counteract	32
16-316	16 oz. Counteract	28



**EASY TO USE,  
BAG-IN-BAG PACKAGING**

Simply open the outer bag, remove the inner bag and throw the inner bag inside the tire before inflating. This method allows the use of an air blaster and will not contaminate the bead seating area.

Scan QR For Tire Size Application



[www.31inc.com/counteract.pdf](http://www.31inc.com/counteract.pdf)



## PolyPadz

- The most popular lift pads manufactured with polyurethane
- Outlasts standard rubber pads many times
- **You may never need to buy a lift pad again!**

**PolyPadz**™



**You may never need to buy a lift pad again!**

POLYPADZ			
Part Number	Lift Manufacturer	L x W x H (Inches)	Bolt Hole Pattern (Center to Center)
14-2600	Ammco/Ben Pearson/Challenger/Weaver	4 3/4 x 4 x 1	3/4
14-2601	Benwill/Bishamon/Coats	4 1/2 x 3 5/8 x 3/4	1 5/8 (W) x 1 5/8 (H)
14-2602	Challenger VBM Round/Rotary RTP 10	5 3/4 x 5 3/4 x 1/4	3
14-2603	American/Eagle/Forward/Gemini/Worth	5 x 5 x 1/4	3-3/4
14-2605	Force (old)/Nussbaum/Phoenix	5 x 5 x 1	3-1/2
14-2609	Rotary SPO 12	4 1/2 x 3 1/2 x 1/2	2 1/4 (W) x 3
14-2610	Ammco Square/Snap-On/Wheeltronics	5 x 4 1/4 x 3/4	n/a
14-2617	Challenger CL9 and CL10	4 x 4 x 1/2	3
14-2621	Ammco TLS Lifts	4 1/2 x 3 1/4 x 1	1 1/2 (W) x 2 1/2 (H)

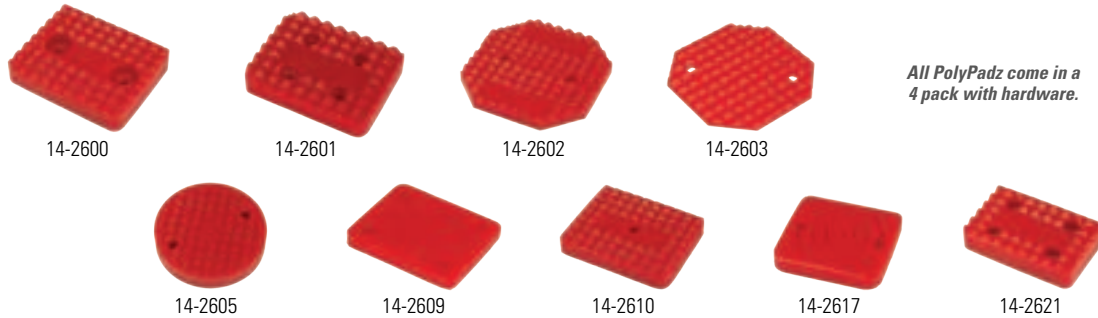

*All PolyPadz come in a 4 pack with hardware.*

## Rubber Lift Pads

RUBBER LIFT PADS			
Part Number	Lift Manufacturer	L x W x H (Inches)	Bolt Hole Pattern (Center to Center in Inches)
14-2650	Ammco/Ben Pearson/Challenger/Weaver	3 3/4 x 5 3/4 x 7/8	3/4
14-2651	Benwill/Bishamon	4 1/2 x 3 5/8 x 3/4	1 7/8 (W) x 1 5/8 (H)
14-2652	Challenger VBM Round	5 7/8 x 5 7/8 x 1/4	3
14-2653	American/Eagle/Forward/Gemini/Worth	5 x 5 x 1/4	3 3/4
14-2655	Force (old)/Nussbaum/Phoenix	5 x 5 x 1	3 1/2
14-2659	Rotary SPO 12	4 x 3 1/4 x 1/4	3 (W) x 2 3/8 (L)
14-2660	Ammco Square/Snap-On/Wheeltronics	5 1/4 x 4 1/2 x 1	-
14-2667	Challenger CL9 and CL10	4 x 4 x 7/16	-
14-2671	TLS Globe	3 x 4 1/2 x 1	2 3/8 (W) x 1 5/8 (H)

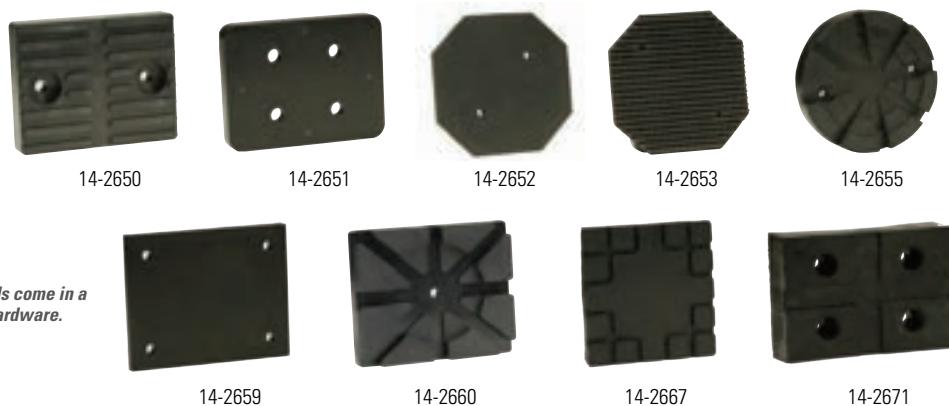

*All rubber lift pads come in a 4 pack with hardware.*

## TIRE CHANGING ACCESSORIES

### MOUNT / DEMOUNT HEADS

31 Inc. Part Number	OEM	OEM Part Number	Tire Changer Model
<b>14-9682</b>	Stainless Steel Head with Round Hole		
Coats	8183429	RC 1, 5, 10, 15, 20, Early 5060	
Corghi	258458	All Models	
<b>14-969</b>	Nylon Head		
Accuturn	20024335	3602, 3602HP, 4260, 4560MR, 4602, 5602, 5602 HP	
Hofmann	ST0024335	1000, 1520, 1565, 1575, 1620, 1625, 1625EM, 3300, 3300EM, 3550	
John Bean	24335	EHP Series Tire Changers	
Snap-On	20024335	All Models	
<b>14-9691</b>	Nylon Head Kit		
Accuturn	14024784	3602, 3602HP, 4260, 4560MR, 4602, 5602, 5602 HP	
Hofmann	4024784	1000, 1520, 1565, 1575, 1620, 1625, 1625EM, 3300, 3300EM, 3550	
John Bean	EAA 0247G20A	EHP Series Tire Changers	
Snap-On	EAA 0247G20A	All Models	
<b>14-969Y</b>	Yellow Nylon Mount/Demount Head for Snap-On		
Snap-On	EAC0060G68A	All Models	
<b>14-970</b>	Nylon Head Kit with Tapered Hole		
Coats	8183061	RC100, RC150, RC200, 5030, 5035, 5045, 5040,	
	8182960	5050 Series, 5060 Series, 5065 Series, 6050, 6060,	
	(head only)	6065, 7050, 7055, 7060, 7065, 7655, 7660, 7665,	
	8184410 (25 Pk)	Baseline BL200, BL300, BL400, BL500	
<b>14-970G</b>	Low Profile Grey Nylon Mount/Demount Head Kit for Use with Low Profile Tires		
Coats	8184432	RC100, RC150, RC200, 5030, 5035, 5045, 5040,	
	8184426	5050 Series, 5060 Series, 5065 Series, 6050, 6060,	
	85000372 (25 Pk)	6065, 7050, 7055, 7060, 7065, 7655, 7660, 7665,	
		Baseline BL200, BL300, BL400, BL500	
<b>14-9702</b>	Stainless Steel Head with Tapered Hole for Coats		
Coats	8182788	RC100, RC150, RC200, 5030, 5035, 5045, 5040,	
		5050 Series, 5060 Series, 5065 Series, 6050, 6060	
		6065, 7050, 7055, 7060, 7065, 7655, 7660, 7665,	
		Baseline BL200, BL300, BL400, BL500, APX 80 and	
		APX90 Requires Shaft Reversal to Use Metal Head	
<b>14-971</b>	Nylon Head with Round Hole Head Only		
Corghi	450310	All Rim Clamp	
All Tool	2008401	All Models	
Hoffman	8314813	1550, 1510, 1610, 3200, 3500, 5410, S408MAXI	
		Not for Use On Hofmann 1620 and 1625	
Cemb	3008403	All Models	
Sice	8314813	M39, S40, S41, S42, S43, S45, S408MAXI,	
		S435, S436, S436TOP	
Coats	83008403	RC 1, 5, 10, 15, 20, Early 5060, 9010, 9024,	
		APX 80, APX90	
Giuliano	G3008403	All Models	
Hunter	RP11-8314813	Fits All TCX Series – Requires Adapter RP11-5-400100 (Earlier TCX500 Requires Upgrade Shaft/Adapter Kit RP11-8-11400091)	



14-9682



14-969



14-9691



14-969Y



14-970



14-970G



14-9702



14-971



<b>14-9711</b>	Nylon Head Kit with Round Hole	
Corgi	250309	All Rim Clamp
All Tool	2008402	All Models
Cemb	2008402	All Models
Hoffman	2200981	1550, 1510, 1610, 3200, 3500, 5410, S408Maxi, Not For Use On Hofmann 1620 and 1625
Coats	82008402	RC 1, 5, 10, 15, 20, Early 5060, 9010, 9024, APX 80, APX 90
Giuliano	G2008402	All Models



14-9711

<b>14-972</b>	Nylon Head (14-972R – Red)		
<b>14-972R</b>	Ranger	5150523	2R-980XR, R-980NXT, R-30XLT Requires Mounting Flange 5150524
	Hunter	RP6 0343B 221-675-2 221-675-2-B	TC250, TC300, TC325, TC350, TC2000, TC3250, TC3500, TC3000, TC3100 Series (Requires Adapter)
	Accuturn	SM102529	Direct Fit On 220A (All Other Models Require 102765 Adapter), 730 Pro
	Sicam	SM102529	32, 520, 526, 530, 720, 726 Grifone 516 and Colibri 512, Falco 3009
	Bosch	SM102529	220S, 4225, 4230, 4335, 4465, 4540, 5210, 5320 Direct Fit On 220A (All Other Models Require 102765 Adapter)



14-972

14-972R



14-972W

<b>14-972W</b>	Wide Tool Head for Hunter TCA34 Tire Changers with Serial Number 664 and Above	
	Hunter	RP6-710014120 TCA34 with Serial Number 664 and Above

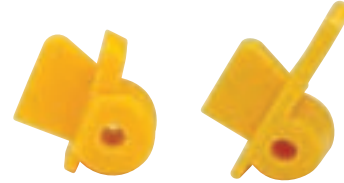

14-941

14-942

**STAINLESS STEEL INSERTS AND BOOTIES**

31 Inc. Part Number	OEM	OEM Part Number	Tire Changer Model
<b>14-941</b>	Yellow Nylon Plastic Insert for Stainless Steel Head		
	Accuturn	20011064 24016079	3402, 3450, 3602, 4602 5802HP, 5850HP, 5602
<b>14-942</b>	Yellow Long Plastic Insert for Stainless Steel Heads		
	Snap-On	EAC0060G76A	All Models
<b>14-943</b>	Plastic Insert for Sicam Tire Changer (5 Pk)		
	Sicam	SM101608	
	Accuturn		All Models
	Bosch		
<b>14-944</b>	Insert Kit for Hunter Steel Mounthead (10 Pcs Each TI4096 and TI4636)		
	Hunter	RP8-11-11400096	TCX Series
<b>14-945</b>	Plastic Long Inserts for Stainless Mount and Demount Head (10 Pk)		
	Hofmann	ST4024181	All Models
	Snap-On	EAA0247G15A	All Models
<b>14-973</b>	Plastic Insert for 14-9702 and 14-9682 Stainless Steel Heads (12 Pk)		
<b>14-973-2</b>	Plastic Insert for 14-9702 and 14-9682 Stainless Steel Heads (2 Pk)		
	Coats	8182961 (2 Pk) 8182963 (12 Pk)	RC100, RC150, RC200, 5030, 5035, 5045, 5040 5050 Series, 5060 Series, 5065 Series, 6050, 6060, 6065, 7050, 7055, 7060, 7065, 7655, 7660, 7665, Baseline BL200, BL300, BL400, BL500, APX 80 and APX90
<b>14-974</b>	Plastic Inserts for Mount and Demount Head (10 Pk) Includes Allen Wrench		
	Coats	89209611	9010, 9024
<b>14-975</b>	Plastic Inserts for Mount and Demount Head (10 Pk)		
	Accuturn	20011064	3402, 3450, 3602, 4602, 5802HP, 5850HP, 5602
<b>14-976</b>	Small White Mount Bootie for Coats Combo Tool 14-978 (10 Pk)		
<b>14-977</b>	Large White Demount Bootie for Coats Combo Tool 14-978 (10 Pk)		



14-943



14-944

14-945



14-973 and 14-973-2

14-974

14-975



14-976

14-977

**JAWS, CLAMPING KITS**

31 Inc. Part Number	OEM	OEM Part Number	Tire Changer Model
<b>14-958</b>	3 Position Extended X-Clamp Kit for Coats X-Models with Adjustable Carriers. External (Outside / In) Wheel Clamping 6" - 22" Wheels Kit Includes: Position Push Buttons (4 Pcs), 3 Position X-Clamp (4 Pcs) Coats 8113125C 50X, 60X, 70X		
<b>14-959</b>	24" X-Out Clamp Kit for Clamping 23" and 24" Alloy Wheels 13" - 24" Range. 2 Position Clamps. Outside Clamping Only. Kit Includes: 24" X-Out Clamps (4 Pcs), Position Push Buttons (4 Pcs), 14-960 Quilted Clamp Socks (10 Pcs) Coats 8184327 50X, 60X, 70X		
<b>14-960</b>	Quilted Clamp Socks for Jaws and Coats Rim Clamp Tire Changers (10 Pk) Coats 8183604 All Tire Changers Except 9010 and 9024E		



14-958



14-959



14-960

**TIRE CHANGER ACCESSORIES**

Part Number	Description
<b>14-931</b>	Bead Lifting Tool
<b>14-932</b>	Long Sock for 14-931 Bead Lifting Tool (4 Pk)
<b>14-978</b>	Mount/Demount Combo Tool For Coats 4040, 4050 and other Center Post Changers
<b>14-979</b>	MX Mounting Clamp for Mounting Low Profile Tires For Use with Rim Clamp Tire Changers



14-931

14-932



14-978



14-979

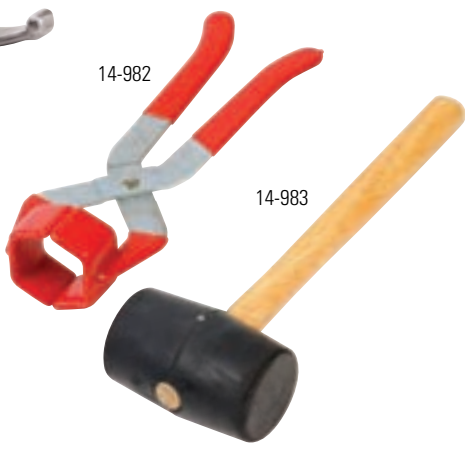

14-982

14-983

**MISCELLANEOUS WHEEL SERVICE TOOLS**

Part Number	Description
14-982	Chrome Nut Cover Pliers
14-983	32 oz. Rubber Mallet

## TIRE CHANGING TOOLS

### 14-918 Nut Buddy

The Nut Buddy manual lug loosener busts loose the most stubborn wheel nuts. Reduces fatigue. For commercial and agricultural wheels.

- Constructed of steel
- Rated output torque 2950 ft lbs. Inside gear ratio 58:1
- Includes two sockets – 1 1/2" and 1 5/16"



14-918

### 14-919 Nut Buddy Jr.

The Nut Buddy Jr. busts loose the most stubborn wheel nuts. For use on cars and light trucks.

- Gear ratio – 18:1. Rated output torque 885 ft lbs.
- Three sockets included: 17mm, 19mm, 21mm



14-919

#### LUG LOOSENERS

Part Number	Description	Socket Sizes	Weight
14-918	Nut Buddy Lug Loosener	1 1/2" 1 5/16"	19 lbs.
14-919	Nut Buddy Junior Automotive Lug Loosener	17mm, 19mm 21mm	5 lbs.

## Counteract Stud Cleaning Tools

- Quickly and effectively removes rust and debris from wheel studs using your air wrench or handheld power drill (with included adapter)

#### COUNTERACT STUD CLEANING TOOLS

Part Number	Size
16-401	SM Stud Cleaning Brush for 12mm, 13mm, 14mm, 16mm
16-402	MD Stud Cleaning Brush for 22mm
16-403	LG Stud Cleaning Brush for 28mm
16-412	12mm Cartridge for SM Stud Brush
16-413	13mm Cartridge for SM Stud Brush
16-414	14mm Cartridge for SM Stud Brush
16-416	16mm Cartridge for SM Stud Brush
16-422	22mm Cartridge for MD Stud Brush
16-428	28mm Cartridge for LG Stud Brush



Watch Them In Action



### Hub Buddy

Impact rated – no need to change tools. Comply with best practice R.I.S.T. procedure. Removes rust, corrosion and other build-up from wheel stud, drums and tire rim. Helps proper torque of lug nuts by removing corrosion. A must for easy and accurate tire balancing.

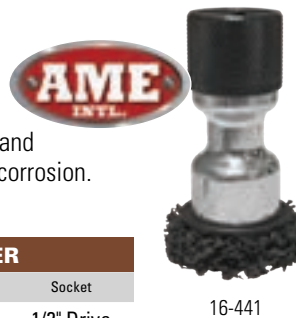

16-441



16-445

#### HUB BUDDY WHEEL & RIM CLEANER

Part Number	Description	Length	Socket
16-441	Hub Buddy & 1 Cleaning Disk Head	3.75"	1/2" Drive
16-445	Replacement Pads (Pk of 6)		1/2" Drive

# LUG NUTS & SPLINE ADAPTERS

## Chrome Lug Nuts

OPEN-END BULGE ACORN			
Part Number	Thread Size	Box Qty	Case Qty
14-850 7/16	7/16"	50	500
14-850 1/2	1/2"	50	500
14-850 12/1.25	12mm 1.25	50	500
14-850 12/1.50	12mm 1.50	50	500
14-850 12/1.75	12mm 1.75	50	500
14-850 14/1.50	14mm 1.50	50	500
14-850 14/2.00	14mm 2.00	50	500
14-850 9/16	9/16"	50	500

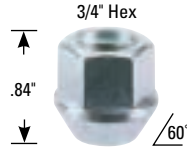

BULGE ACORN - 1.38" LONG			
Part Number	Thread Size	Box Qty	Case Qty
14-857 7/16	7/16"	50	500
14-857 1/2	1/2"	50	500
14-857 12/1.25	12mm 1.25	50	500
14-857 12/1.50	12mm 1.50	50	500
14-857 12/1.75	12mm 1.75	50	500
14-857 14/1.50	14mm 1.50	50	500

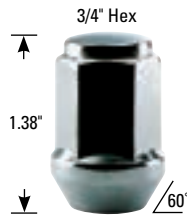

BULGE ACORN - 1.75" LONG			
Part Number	Thread Size	Box Qty	Case Qty
14-858 1/2	1/2"	40	400
14-858 12/1.50	12mm 1.50	40	400
14-858 12/1.75	12mm 1.75	40	400
14-858 14/1.50	14mm 1.50	40	400
14-858 14/2.00	14mm 2.00	40	400
14-858 9/16	9/16"	40	400



BULGE ACORN - 1.90" LONG			
Part Number	Thread Size	Box Qty	Case Qty
14-859 12/1.50	12mm 1.50	30	300
14-859 12/1.75	12mm 1.75	30	300
14-859 14/1.50	14mm 1.50	30	300
14-859 14/2.00	14mm 2.00	30	300
14-859 9/16	9/16"	30	300



BULGE ACORN - 2.32" LONG			
Part Number	Thread Size	Box Qty	Case Qty
14-860 12/1.75	12mm 1.75	30	300
14-860 14/1.50	14mm 1.50	30	300
14-860 14/2.00	14mm 2.00	30	300

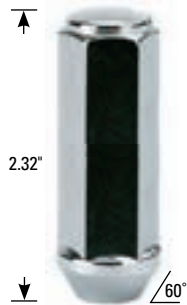

SPLINE ACORN			
Use Key Adapter 14-861A or 14-861B			
Part Number	Thread Size	Box Qty	Case Qty
14-861 1/2	1/2"	50	500
14-861 12/1.25	12mm 1.25	50	500
14-861 12/1.50	12mm 1.50	50	500
14-861 12/1.75	12mm 1.75	50	500

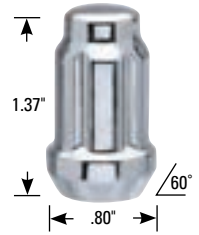

OPEN-END SPLINE			
Use Key Adapter 14-861A			
Part Number	Thread Size	Box Qty	Case Qty
14-862 1/2	1/2"	50	500
14-862 12/1.25	12mm 1.25	50	500
14-862 12/1.50	12mm 1.50	50	500

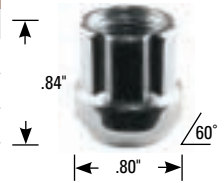

DUPLEX SHORT SPLINE			
Use Key Adapter 14-863A			
Part Number	Thread Size	Box Qty	Case Qty
14-863 14/1.50	14mm 1.50	50	500
14-863 14/2.00	14mm 2.00	50	500
14-863 9/16	9/16"	50	500

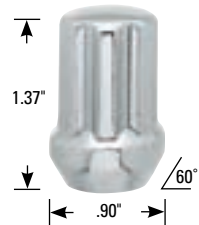

DUPLEX SPLINE ACORN LONG			
Use Key Adapter 14-863A			
Part Number	Thread Size	Box Qty	Case Qty
14-864 12/1.50	12mm 1.50	40	400
14-864 12/1.75	12mm 1.75	40	400
14-864 14/1.50	14mm 1.50	40	400
14-864 14/2.00	14mm 2.00	40	400
14-864 9/16	9/16"	40	400

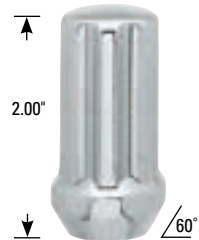

TUNER ACORN HEAT TREATED			
Use Key Adapter 14-865A or 14-865B			
Part Number	Thread Size	Box Qty	Case Qty
14-865 1/2	1/2"	50	500
14-865 12/1.25	12mm 1.25	50	500
14-865 12/1.50	12mm 1.50	50	500
14-865 14/1.50	14mm 1.50	50	500

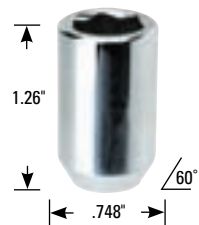



## Spline Adapters

### SPLINE & TUNER ADAPTERS

Part Number	Description
14-861A	Key Adapter, 3/4" and 13/16" (6 Spline)
14-861B	Key Adapter, 17mm and 19mm (6 Spline)
14-863A	Key Adapter 13/16" and 7/8" (7 Spline)
14-865A	Socket Adapter, 3/4" and 13/16"
14-865B	Socket Adapter, 17mm and 19mm

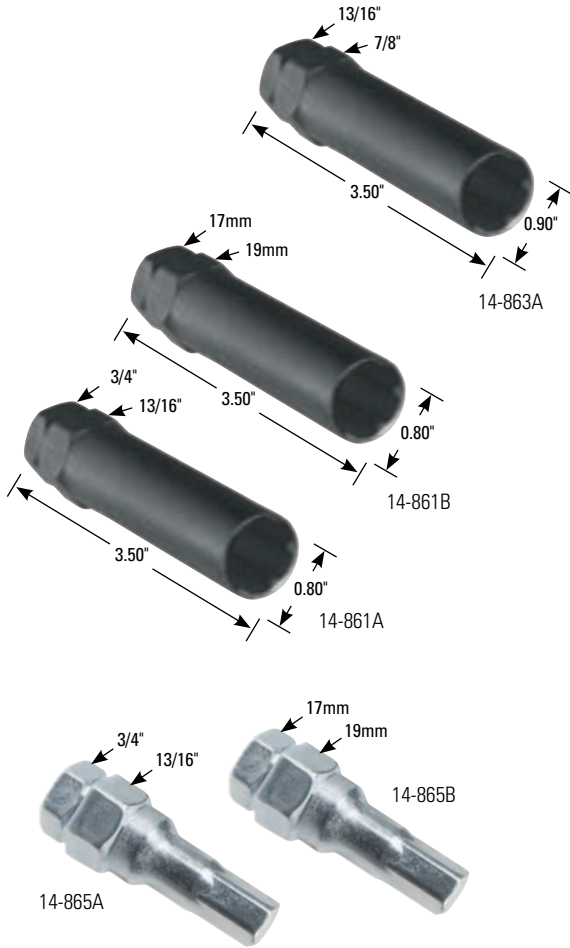

## Wheel Lock Sets

### BULGE ACORN – 1.26" LONG

Part Number	Thread Size	Box Qty	Case Qty
14-890 7/16	7/16"	6 Sets	60
14-890 1/2	1/2"	6 Sets	60
14-890 12/1.25	12mm 1.25	6 Sets	60
14-890 12/1.50	12mm 1.50	6 Sets	60
14-890 14/1.50	14mm 1.50	6 Sets	60

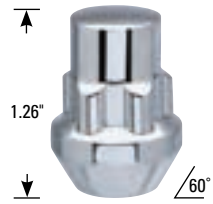

### BULGE ACORN – 1.76" LONG

Part Number	Thread Size	Box Qty	Case Qty
14-891 1/2	1/2"	6 Sets	60
14-891 12/1.50	12mm 1.50	6 Sets	60
14-891 12/1.75	12mm 1.75	6 Sets	60
14-891 14/1.50	14mm 1.50	6 Sets	60
14-891 14/2.00	14mm 2.00	6 Sets	60

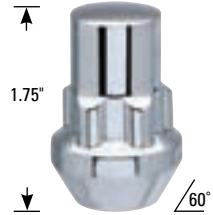

### BULGE ACORN – 1.90" LONG

Part Number	Thread Size	Box Qty	Case Qty
14-892 1/2	1/2"	6 Sets	60
14-892 12/1.50	12mm 1.50	6 Sets	60
14-892 12/1.75	12mm 1.75	6 Sets	60
14-892 14/1.50	14mm 1.50	6 Sets	60
14-892 14/2.00	14mm 2.00	6 Sets	60

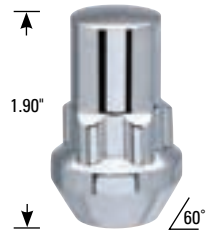

### BULGE ACORN – 2.32" LONG

Part Number	Thread Size	Box Qty	Case Qty
14-893 12/1.75	12mm 1.75	6 Sets	60
14-893 14/1.50	14mm 1.50	6 Sets	60
14-893 14/2.00	14mm 2.00	6 Sets	60



### 2-PIECE ACORN

Part Number	Thread Size	Box Qty	Case Qty
14-854 7/16	7/16"	50	500
14-854 1/2	1/2"	50	500
14-854 12/1.25	12mm 1.25	50	500
14-854 12/1.50	12mm 1.50	50	500
14-854 14/1.50	14mm 1.50	50	500





## Makes TPMS as Simple as...

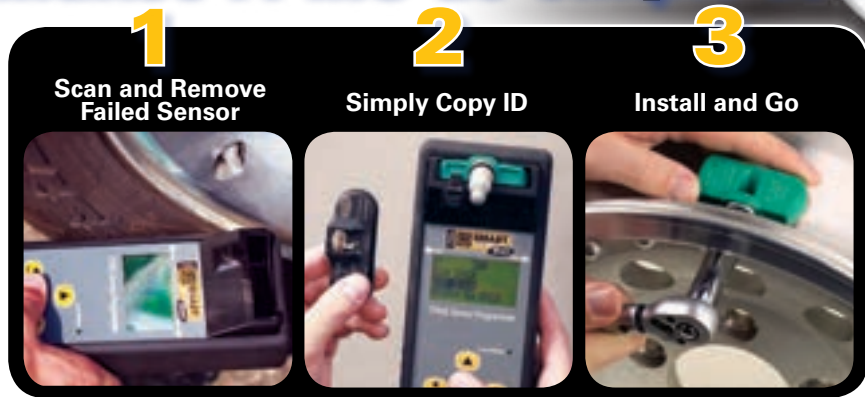

**17-144**  
**Smart Sensor Pro+**  
**Diagnostic/Programming**  
**Tool**

### THE SMART TPMS SOLUTION

- Only 2 sensors to service more than 95% of all vehicle applications!
- Easy to learn and use with lifetime FREE updates!
- OBDII Module available – Relearn Asian vehicles!
- **Program** or **copy** a sensor, using the Pro+ Tool, in just seconds.
- Pro+ Tool is a relearn tool too!
- Snap-in and clamp-in sensors available.
- Smart Sensors can be triggered by other TPMS tools.

**95%**  
**Vehicle Coverage**

**17-144-2**  
**OBDII Module for**  
**Smart Sensor Pro+**



#### SMART SENSOR PRO+ TOOLS & ACCESSORIES

Part Number	Description
<b>17-144</b>	Pro+ Diagnostic/Programming Tool
<b>17-144-2</b>	OBDII Module for Smart Sensor Pro+
<b>17-144-4</b>	Charger for 17-144 Pro+ Tool
<b>17-43011</b>	315MHz Smart Sensor, Snap-In (Green)
<b>17-43012</b>	433MHz Smart Sensor, Snap-In (Brown)
<b>17-43013</b>	315MHz Smart Sensor, Clamp-In (Green)
<b>17-43014</b>	433MHz Smart Sensor, Clamp-In (Brown)
<b>17-43024</b>	433MHz Auto Locate Smart Sensor (BMW/Chrysler/Mercedes)
<b>17-43001</b>	<b>Clamp-In Smart Sensor Bundle</b> 1 – Programming Tool (17-144) 4 – 315MHz Sensors (17-43013) 4 – 433MHz Sensors (17-43014)
<b>17-43006</b>	<b>Snap-In Smart Sensor Bundle</b> 1 – Programming Tool (17-144) 4 – 315MHz Sensors (17-43011) 4 – 433MHz Sensors (17-43012)

17-43012



17-43011

17-43014



17-43013

17-43024



#### SMART SENSOR VALVE STEMS

Part Number	Description
<b>17-43016</b>	Replacement Snap-In Valve for 17-43011/17-43012
<b>17-43017</b>	Gloss Black Replacement Valve for 17-43013/17-43014/17-43024
<b>17-43018</b>	Matte Black Replacement Valve for 17-43013/17-43014/17-43024
<b>17-43019</b>	Aluminum Replacement Valve for 17-43013/17-43014/17-43024
<b>17-43020</b>	Polished Chrome Replacement Valve for 17-43013/17-43014/17-43024

17-43018

17-43017

17-43016

17-43019

17-43020



## TECHNICAL APPLICATION DATA

19-122

### TIA TPMS Relearn Chart

- Laminated Heavy-Duty Pages
- Designed for the Shop Environment
- Industry Researched Relearn Procedures
- For Domestic and Import Vehicles



### Website Resources

- 31 Inc. Printable PDF Application Chart
  - [www.31inc.com/tpms.pdf](http://www.31inc.com/tpms.pdf)
  - Color coded to quickly find the right part
  - Updated regularly
- TPMS Part Finder
  - [www.31inc.com/partfinder](http://www.31inc.com/partfinder)
  - Live make, model, year lookup data
  - Printable PDF relearn procedures
- [www.SmartSensorUpdate.com](http://www.SmartSensorUpdate.com)
  - Quick and easy tool updates
  - Tool updates FREE for life
  - Stay connected for important helpful information

[www.31inc.com/partfinder](http://www.31inc.com/partfinder)



[www.SmartSensorUpdate.com](http://www.SmartSensorUpdate.com)

**TECHNICAL SUPPORT**

**VIDEOS**

**FREE UPDATES**

**TECHNICAL INFO**

**Smart Sensor Update**  
Pro+ Tool Updates and TPMS Information

Technical Support  
1.877.659.TPMS (8767)  
Reseller / User ID

UPDATE PRO+ | PRODUCT INFORMATION | TRAINING & SUPPORT | CONTACT US

### How Do I Update My Pro+ Tool?

**DOWNLOAD**

Pro+ Updater.zip

1. Log into Your SmartSensorUpdate account and download the software. After download finishes, extract and install Pro+ Updater software. [New Users Register HERE](#)
2. Connect Pro+ Tool to Computer with USB Cable and Power Tool On.
3. Open Pro+ Updater Software and Press UPDATE. That's It!



# TPMS PARTS KIT ASSORTMENTS

## Top 10 Most Popular

17-21303 REPLACEMENT PARTS ASSORTMENT		
Part Number	General Application*	Qty
17-20008	Rubber Snap-In Valve GM	8
17-20107AK	GM	8
17-20096AK	Ford	8
17-20018	Rubber Snap-In Valve Ford	8
17-20013AK	Chrysler, Dodge, Jeep	8
17-20028AK	Chrysler, Dodge, Mitsubishi	8
17-20201AK	Chrysler	8
17-20014AK	Nissan, Infiniti	8
17-20204AK	Acura, Honda, Kia	8
17-20206AK	Hyundai, Honda, Kia	8
17-20211AK	Misc. Imports	8
17-20216AK	Lexus, Toyota	8
17-20217AK	Lexus, Toyota	8
17-490T	Nickel Plated TPMS Valve Cores	100
17-1731	Valve Core Torque Tool	1
17-492L-1	Long Black Plastic TPMS Caps	80
17-492T-1	Gray Plastic TPMS Caps	100

### Domestic Vehicles

17-21305 REPLACEMENT PARTS ASSORTMENT		
Part Number	General Application*	Qty
17-20006AK	GMC, Hummer, Isuzu	10
17-20008	Rubber Snap-In TPMS valve	20
17-20012AK	Prowler & Corvette	10
17-20013AK	Chrysler, Dodge, Jeep	20
17-20015AK	GM with TRW Clamp-In	10
17-20028AK	Chrysler, Dodge, Mitsubishi	20
17-20096AK	Ford	10
17-20107AK	GM	20
17-20198AK	Dodge Sprinter	5
17-20201AK	Chrysler	20
17-173	Valve Core Torque Tool	1
17-490T	Nickel Plated TPMS Valve Cores	100
17-492L-1	Long Black Plastic TPMS Caps	100
17-492T-1	Gray Plastic TPMS Caps	100

### Import Vehicles

17-21306 REPLACEMENT PARTS ASSORTMENT		
Part Number	General Application*	Qty
17-20005AK	Nissan	10
17-20007AK	Nissan, Infiniti	10
17-20009AK	Saab, Suzuki	10
17-20010AK	Volvo	10
17-20011AK	Subaru	10
17-20014AK	Nissan, Infiniti	10
17-20016AK	Mercedes	10
17-20035AK	Honda	5
17-20036AK	Acura, Honda, Kia	5
17-20202AK	Audi, Mercedes, Volkswagen	10
17-20203AK	Audi, Mercedes	5
17-20204AK	Acura, Honda, Kia	10
17-20206AK	Hyundai, Honda, Kia	10
17-20207AK	Volkswagen	10
17-20211AK	Misc. Imports	10
17-20216AK	Lexus, Toyota	10
17-20217AK	Lexus, Toyota	10
17-20221AK	Lexus SC430	10

### 17-21303 Assortment Includes:

- 104 Service Kits for the Most Popular Domestic and Import Vehicle TPMS Sensors
- 100 TPMS Valve Cores
- 180 TPMS Plastic Valve Caps
- TPMS Valve Core Torque Tool



17-21303

### 17-21305 Assortment Includes:

- 145 Replacement Parts Kits
- 100 TPMS Valve Cores
- 200 TPMS Plastic Valve Caps
- TPMS Valve Core Torque Tool
- Application Chart



17-21305

### 17-21306 Assortment Includes:

- 165 Replacement Parts Kits
- Application Chart

Includes all of the necessary component parts to service most TPMS sensors for:

- |            |            |                               |
|------------|------------|-------------------------------|
| • Acura    | • Lexus    | • Volkswagen                  |
| • Audi     | • Mercedes | • Other Miscellaneous Imports |
| • BMW      | • Nissan   |                               |
| • Honda    | • Saab     |                               |
| • Hyundai  | • Subaru   |                               |
| • Infiniti | • Suzuki   |                               |
| • Kia      | • Toyota   |                               |



17-21306

\* Applications are vehicles specific. Visit <http://www.31inc.com> to find the correct application.





## TPMS REPLACEMENT PARTS KITS & VALVE STEMS

Part Number	Qty	Color	Interchange		Description*
17-20005AK	Box / 10	1	20005	1130K	Parts Kit for Nissan
17-20006AK	Box / 10	1	20006		Parts Kit for GMC, Hummer, Isuzu
17-20007AK	Box / 10	2	20007		Parts Kit for Nissan, Infiniti
17-20008	Box / 10	2	20008	VS950	TPMS Snap-In Valve GM Interchangeable with 17-20018
17-20008-50	Box / 50	2	20008	VS950	TPMS Snap-In Valve GM
17-20008C	Box / 10		22008	VS950S	TPMS Snap-In Valve GM with Chromed Plastic Sleeve
17-20009AK	Box / 10	1	20009		Parts Kit for Saab, Suzuki
17-20010AK	Box / 10	2	20010	2010K	Parts Kit for Volvo
17-20011AK	Box / 10	3	20011		Parts Kit for Subaru
17-20012AK	Box / 10	1	20012	1077K	Parts Kit for Prowler, Corvette
17-20013AK	Box / 10	2	20013	2030K	Parts Kit for Dodge, Jeep, Chrysler
17-20014AK	Box / 10	3	20014		Parts Kit for Nissan, Infiniti
17-20015AK	Box / 10	3	20015	2020K	Parts Kit for GM with TRW Clamp-In Sensor
17-20016AK	Box / 10	1	20016		Parts Kit for Mercedes, Smart
17-20018	Box / 10	2	20018	VS950	TPMS Snap-In Valve Ford Interchangeable with 17-20008
17-20020	Box / 10		20020	9066-1	Stem Only for Chrysler, Dodge, Mercedes
17-20020AK	Box / 10	6		9066K	Parts Kit + Stem for Chrysler, Dodge, Mercedes
17-20028AK	Box / 10	3	20003	1080K	Parts Kit for Chrysler, Dodge, Mitsubishi
17-20035AK	Box / 10	1	20035	1097K	Parts Kit for Honda
17-20036AK	Box / 10	2	20036	1096K	Parts Kit for Acura, Honda, Kia
17-20045	Box / 10				TPMS Snap-In Valve GM – High Speed, Parallel Key
17-20046	Box / 10				TPMS Snap-In Valve, Right Angle Key
17-20096AK	Box / 10	1	20002	1060K	Parts Kit for Ford
17-20107AK	Box / 10	4	20004	1070K	Parts Kit for GM
17-20198AK	Box / 10	4		1098K	Parts Kit for Dodge Sprinter
17-20201AK	Box / 10	5	20030	1050K	Parts Kit for Chrysler, GM
17-20202AK	Box / 10	2	20017	1030K	Parts Kit for Audi, Mercedes, Volkswagen
17-20203AK	Box / 10	3		1040K	Parts Kit for Audi, Mercedes
17-20204AK	Box / 10	3	20019	2040K	Parts Kit for Acura, Honda, Kia
17-20206AK	Box / 10	4	20021	2000K	Parts Kit for Hyundai, Honda Kia
17-20207AK	Box / 10	4		1031K	Parts Kit for Volkswagen
17-20211AK	Box / 10	4	20023	1090K	Parts Kit for Misc. Imports
17-20216AK	Box / 10	1	20032	1100K	Parts Kit for Lexus/Toyota
17-20217AK	Box / 10	2	20031	1110K	Parts Kit for Lexus/Toyota
17-20221AK	Box / 10	3		1120K	Parts Kit for Lexus SC430
17-20223AK	Box / 10				TPMS Valve Kit for GM (SS Corvette)
17-20720AK	Box / 10	5		7020K	Parts Kit 7020 for Jag, Range Rover, Volvo (54190)
17-20725AK	Box / 10	5			Parts Kit + Stem for Continental Sensors
17-50340	Each		20037	1092	590340 Alligator TPMS Kit 43LMS
17-50342	Each		20038	1093	590342 Alligator TPMS Kit 48LMS
17-50344	Each		20039	1094	590344 Alligator TPMS Kit 49LMS
17-50346	Each		20040	1095	590346 Alligator TPMS Kit 51LMS
17-50390	Each				Metal TPMS Valve Stem for Ford
17-50391	Box / 10				TPMS Metal Clamp-In Valve for TRW Screw-In
17-50395	Box / 10			VS65	TRW Snap-In Sensor Rubber Valve Stem, Square Key
17-50396	Each				TPMS Valve for Dodge Ram Dually with Aluminium Wheels
17-50397	Box / 10			VS90	Continental Snap-In Sensor Rubber Valve Stem
17-50399	Box / 10			VS1010	TPMS Snap-In Valve Hyundai

\* Applications are vehicles specific. Visit <http://www.31inc.com> to find the correct application.

# TPMS SERVICE KITS



17-20005AK



17-20006AK



17-20007AK



17-20009AK



17-20010AK



17-20011AK



17-20012AK



17-20013AK



17-20014AK



17-20015AK



17-20016AK



17-20028AK



17-20096AK



17-20107AK



17-20201AK



17-20202AK



17-20204AK



17-20206AK



17-20207AK



17-20211AK



17-20216AK



17-20217AK



17-20221AK



17-20720AK

Each service kit is barcoded and color coded for easy identification.



## TIREtips

Get the latest application information at [www.31inc.com/tpms.pdf](http://www.31inc.com/tpms.pdf)

Components are application specific. Grommets are not interchangeable. Design is based on OE wheel and sensor fitment.

# TPMS VALVE KITS



17-20020AK



17-20035AK



17-20036AK



17-20198AK



17-20203AK



17-20223AK



17-20725AK



17-50340



17-50342



17-50344



17-50346



17-50390



17-50391



17-50396



17-20020

## Snap-In Stems

- Self tapping screws
- 11.5 in/lbs screw torque
- 80 psi maximum cold inflation pressure



17-20008

PARALLEL KEY



17-20008C

PARALLEL KEY



17-20018

PARALLEL KEY

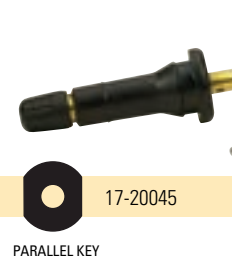

17-20045

PARALLEL KEY



17-20046

RIGHT ANGLE KEY



17-50395

SQUARE KEY



17-50397  
CLIP LOCK



17-50399  
LOCK NUT

### technician tip

#### It's Critical to Always Replace (NEVER REUSE) the Special Sealing Components (Core, Cap, Nut, Grommet)

- Rubber grommets are designed for a single use. Over time, they take a shape, and lose their ability to properly seal. They are no different than the rubber washer in your faucet at home. Over time they take a shape and start to leak.
- Special TPMS valve cores are designed for use with aluminum TPMS stems. These special cores are coated with an electroless nickel plating that prevent them from oxidizing to the aluminum TPMS stems. Never reuse a valve core, and never use a normal brass valve core with a TPMS sensor. Always replace the core with a new TPMS valve core.

#### BEST PRACTICE:

- Always remove the TPMS sensor when servicing the tire/wheel.
- Always replace the Special Sealing Components with a NEW REPLACEMENT PARTS KIT.

## TPMS SERVICE TOOLS

### 17-168

#### TPMS Tool Kit Assortment

- Includes all the small TPMS tools necessary for TPMS service
- Comes in a high-quality blow molded storage case



17-168



### 17-173

#### Valve Core Torque Tool

17-173

- Durable, precision torque tool with a torque specification of 4 in-lbs.
- Use when installing TPMS valve cores to prevent over tightening which can damage the TPMS valve by stripping the valves internal threads or removing the nickel plating of the core resulting in corrosion

### 17-169

#### Grommet Removal Tool

- Fast and easy to use.
- Works perfectly on difficult to remove grommets
- Sturdy, large design fits easily in your hands
- Durable poly construction



17-169

### 17-161A

#### Nut Torque Wrench with Sockets

- Fast, accurate and easy to use
- Use for precise torquing of TPMS nuts to the manufacturers specifications



17-161A

### 17-167A

#### T-10 Torque Tool

- Precision torque tool with a torque specification of 11.5 in-lbs.
- For use when replacing the rubber snap-in valve stem for some TPMS sensors



17-167A

### 17-170

#### Grommet Removal Pick

- Many TPMS valve stems have a design style where the grommet seats within a recessed gap in the aluminum stem, making it difficult to remove by other methods
- The TPMS Grommet Pick quickly and effectively aids in the removal of these hard-to-reach grommets
- Features a hook-angle design with slightly-dull tip for safe and easy removal



17-170





## TPMS ACCESSORIES



17-21102

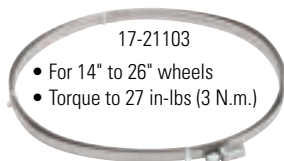

- For 14" to 26" wheels
- Torque to 27 in-lbs (3 N.m.)

CARDED VALVE HARDWARE			
PART NO.	CARD QTY.	BOX QTY.	CASE QTY.
–	–	–	–
15-4904	4	6	72
–	–	–	–
15-4922	4	6	72
–	–	–	–
15-4927	4	6	72
–	–	–	–
15-4925	4	6	72
15-4935	4	6	72
15-4932	4	6	72
–	–	–	–
15-4933	Set	6	72

DESCRIPTION
Green O-Ring Identification Ring for Nitrogen
TPMS High Temp Valve Core, Nickel Plated, Red Seal
TPMS High Temp Valve Core, Nickel Plated, Yellow Seal
TR #VC-8, Black Plastic Valve Cap with Red Silicone Seal
Dark Green Plastic Valve Cap with Red Silicone Seal
Long Skirted Black Plastic Cap with Seal for 17-20008
Long Skirted Green Plastic Cap with Seal
Gray Plastic TPMS Valve Cap with Red Silicone Seal
Chromed Plastic Hex Valve Cap with Green Top
Chromed Plastic Hex Valve Cap
Chromed Plastic Sleeve for 17-20008
Chrome Plastic Sleeve and Cap Set
Cradle with Clip for Mounting Band
Replacement Clip for Mounting Band
Mounting Band for Banded Sensors
TPMS Sensor Service Tool

BULK VALVE HARDWARE	
PART NO.	UNIT QTY
17-489	100
17-490T	100
17-490TY	100
17-492-1	100
17-492G-1	100
17-492L-1	100
17-492LG-1	100
17-492T-1	100
17-493NP	100
17-493P	100
17-494T	100
–	–
17-21101	Each
17-21102	Each
17-21103	Each
17-601	Each

CARDED	–	15-4904	–	15-4922	–	15-4927	–	15-4925	15-4935	15-4932	–
BULK	17-489	17-490T	17-490TY	17-492-1	17-492G-1	17-492L-1	17-492LG-1	17-492T-1	17-493NP	17-493P	17-494T



### 17-601 TPMS Sensor Service Tool

- Designed to keep the sensor in a safe and secure position after the locking nut has been removed and the sensor is released from the wheel
- The handle of the tool is a 2-way tool: One side is a threaded valve core depressor tool to deflate the tire while the other side is a valve core remover tool

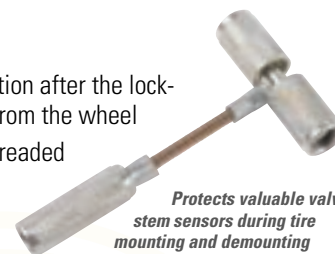

*Protects valuable valve stem sensors during tire mounting and demounting*

### 19-130 TPMS Counter Top Display

- The perfect sales tool for promoting TPMS service
- Multiple visuals displaying the complexity of a TPMS sensor
- Information to help educate the customer
- Displays both snap-in and clamp-in style sensors
- Exposed electronic components aid in technical aspect of selling TPMS service



19-130

## VALVE HARDWARE

As one of the largest suppliers of tire valves to the automotive aftermarket, we supply only valves of the highest quality. We utilize our in-house lab as well as independent laboratories to ensure our valves meet or exceed all industry quality standards.

### PASSENGER & LIGHT TRUCK VALVES

TUBELESS SNAP-IN VALVES					
Part Number	TR Number	Material	(A) Height	Valve Hole	Box Qty*
17-412-50	412	EPDM Rubber	0.88"	.453"	50
17-413-50	413	EPDM Rubber	1.25"	.453"	50
17-414-50	414	EPDM Rubber	1.50"	.453"	50
17-415-50	415	EPDM Rubber	1.25"	.625"	50
17-418-50	418	EPDM Rubber	2.00"	.453"	50
17-423-50	423	EPDM Rubber	2.50"	.453"	50
17-425-50	425	EPDM Rubber	2.00"	.625"	50

**APPLICATION:** 65 psi maximum cold inflation pressure and maximum rim thickness of 0.156".

**NOTE:** H, V, W, Y and Z speed rated tires require a metal bolt-in style valve.

\* For box of 50, use part number 17-413-50, etc.  
For box of 500, use part number 17-413-500, etc.



TUBELESS SNAP-IN VALVES WITH CHROME SLEEVE & CAP					
Part Number	TR Number	Material	(A) Height	Valve Hole	Box Qty*
17-412-1-50	412C	EPDM Rubber	0.88"	.453"	50
17-413-1-50	413C	EPDM Rubber	1.25"	.453"	50
17-414-1-50	414C	EPDM Rubber	1.50"	.453"	50
17-418-1-50	418C	EPDM Rubber	2.00"	.453"	50

**APPLICATION:** 65 psi maximum cold inflation pressure and maximum rim thickness of 0.156".

**NOTE:** H, V, W, Y and Z speed rated tires require a metal bolt-in style valve.

\* For box of 50, use part number 17-412-1-50, etc.  
For box of 500, use part number 17-412-1-500, etc.



HIGH PRESSURE SNAP-IN VALVES					
Part Number	TR Number	Material	(A) Height	Valve Hole	Bag Qty*
17-600HP-50	600HP	Brass/Rubber	1.27"	.453"	50
17-602HP-50	602HP	Brass/Rubber	2.00"	.453"	50
17-801HP-50	801HP	Brass/Rubber	1.31"	.625"	50
17-802HP-50	802HP	Brass/Rubber	2.00"	.625"	50

**APPLICATION:** 600HP / 602HP = 80 psi maximum cold inflation pressure and maximum rim thickness of 0.205".

801HP / 802HP = 100 psi maximum cold inflation pressure and maximum rim thickness of 0.205".

**NOTE:** H, V, W, Y and Z speed rated tires require a metal bolt-in style valve.

\*10 and 500 box qty. available. Add qty. to the part number. Example: 17-600HP-10, 17-600HP-500



TUBE-TYPE REPLACEMENT VALVES					
Part Number	TR Number	Material	(A) Height	Valve Hole	Bag Qty
17-113	13	EPDM Rubber	1.25"	.453"	1
17-115	15	EPDM Rubber	1.25"	.625"	1

**APPLICATION:** 65 psi maximum cold inflation pressure and maximum rim thickness of 0.156".



**BOLT-IN VALVES, FLUSH MOUNT**

Part Number	TR Number	Material	(A) Height	(B) Length	Angle	Valve Hole	Bag Qty*
<b>17-416</b>	416	Nickel Plated Brass	1.44"	–	–	.453"/.625"	50
<b>17-416L</b>		Nickel Plated Brass	2.25"	–	–	.453"/.625"	50
<b>17-417</b>	417	Brass	0.38"	2.50"	70°	.453"	50
<b>17-559</b>		Chrome Plated Brass	1.00"	–	–	.453"/.625"	50

17-416 and 17-416L: Recommended torque at installation: 25-45 in-lbs.

\* 10 count bag available. Add "-10" to the part number. Example: 17-416-10.



**CHROME VALVES, INNER MOUNT**

Part Number	TR Number	Material	(A) Height	(B) Length	Angle	Valve Hole	Bag Qty*
<b>17-560</b>		Chrome Plated Brass	0.75"	–	–	.453"	50
<b>17-560A</b>		Chrome Plated Brass	1.25"	–	–	.453"	50
<b>17-560L</b>		Chrome Plated Brass	1.75"	–	–	.453"	50
<b>17-561</b>		Chrome Plated Brass	0.25"	1.00"	45°	.453"	50
<b>17-562</b>		Chrome Plated Brass	0.75"	1.13"	90°	.453"	50

\* 10 count bag available. Add "-10" to the part number. Example: 17-560-10.



**BOLT-IN VALVES FOR FORD TRUCKS**

Part Number	TR Number	Material	(A) Height	Valve Hole	Bag Qty*
<b>17-428</b>		Chrome Plated Brass	1.50"	.453"	50
<b>17-429</b>		Brass	2.25"	.453"	50

APPLICATION: For Ford "F" Series Trucks with 16" Dual Wheels  
Recommended torque at installation: 25-45 in-lbs.

\* 10 count bag available. Add "-10" to the part number. Example: 17-428-10.



**MOTORCYCLE VALVES**

Part Number	TR Number	Description	Bag Qty*
<b>17-430</b>	430	Tubeless Motorcycle Valve	10

Application: For motorcycle wheels with 0.327"/0.339" valve hole;  
Recommended torque at installation: 25-45 in-lbs.



**Valve Replacement Parts**

**PASSENGER/LIGHT TRUCK**

Part Number	TR Number	Description	Bag Qty*
<b>17-494</b>		Long Chrome Sleeve for TR 418	50
<b>17-495</b>		Short Chrome Sleeve for TR 413/414	100
<b>17-495L</b>		Long Chrome Sleeve for TR 413	100
<b>17-546</b>	RG-54	Small Grommet for 17-416, 17-428, 17-429 and 17-559	25
<b>17-550</b>	RG-39	Large Grommet for 17-416 and 17-559	25
<b>17-553</b>		Top Grommet for 17-560 Series	10
<b>17-554</b>		Bottom Grommet for 17-560 Series	10
<b>17-555</b>	RW-13	Nickel Plated Washer for 17-416 and 17-416L	25



# HEAVY TRUCK VALVES

Using inferior tire valves can expose you to huge liability issues. Protect yourself by using only quality tire valves from XtraSeal. We offer a full range of **heavy truck valves** for both steel and aluminum wheels.

## Brass Heavy Truck Valves

RADIAL COMMANDER VALVES							
Part Number	TR Number	Material	(A) Height	(B) Length	Angle	Valve Hole	Bag Qty*
17-500A		Brass	1.13"	0.87"	23°	.625"	50
17-500AL		Brass	1.38"	1.37"	23°	.625"	50
17-500B		Brass	1.13"	0.87"	21°	.625"	50

\* 10 count bag available. Add "-10" to the part number. Example: 17-500A-10.



BRASS VALVES							
Part Number	TR Number	Material	(A) Height	(B) Length	Angle	Valve Hole	Bag Qty*
17-500T	500	Brass	2.00"	-	-	.625"	50
17-501T	501	Brass	1.50"	-	-	.625"	50
17-501-OV		Brass	1.50"	-	-	oval	50
17-570C	570C	Brass	1.38"	1.88"	90°	.625"	50
17-570T	570	Brass	3.13"	-	-	.625"	50
17-571T	571	Brass	3.38"	-	-	.625"	50
17-572T	572	Brass	3.75"	-	-	.625"	50
17-573T	573	Brass	4.38"	-	-	.625"	50
17-574T	574	Brass	5.00"	-	-	.625"	50
17-575T	575	Brass	1.13"	-	-	.625"	50

Application: For steel wheels with 0.625" valve hole;  
Recommended torque at installation: 35-55 in-lbs.

\* 10 count bag available. Add "-10" to the part number.  
Example: 17-500T-10.



BRASS VALVES (UNASSEMBLES)							
Part Number	TR Number	Material	(A) Height	(B) Length	Angle	Valve Hole	Case Qty
17-572T-U	572	Brass	3.75"	-	-	.625"	250
17-572-B19	572-B19	Brass	1.38"	2.37"	11°	.625"	250
17-572-D12	572-D12	Brass	2.25"	1.50"	21°	.625"	250
17-572-F19	572-F19	Brass	1.38"	2.37"	31°	.625"	250
17-573T-U	573	Brass	4.38"	-	-	.625"	250
17-574-C26	574-C26	Brass	1.75"	3.25"	16°	.625"	250
17-574-E16	574-E16	Brass	3.00"	2.00"	26°	.625"	250
17-574-E28	574-E28	Brass	1.50"	3.50"	26°	.625"	250

Application: For steel wheels with 0.625" valve hole;  
Recommended torque at installation: 35-55 in-lbs.



SCREW-ON REPAIR VALVES							
Part Number	TR Number	Material	(A) Height	(B) Length	Angle	Valve Hole	Bag Qty
17-520	1075A	Brass	0.88"	3.00"	88°	.625"	1
17-521	1078A	Brass	0.88"	5.00"	88°	.625"	1
17-522	1175A	Brass	0.88"	4.50"	88°	.625"	1

Application: Truck and bus tube-type tire.  
Screws onto a tube spud with .482"-26 threads.

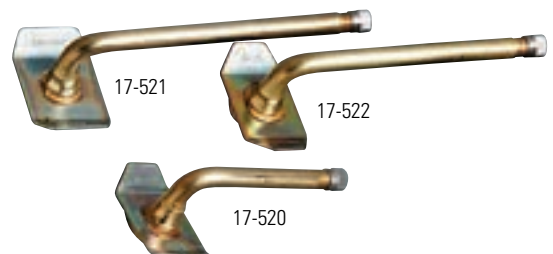



**HIGH TEMPERATURE BRASS VALVE FOR WASTE HAULERS**

Part Number	TR Number	Material	(A) Height	(B) Length	Angle	Valve Hole	Bag Qty*
<b>17-573A</b>		Brass	4.38"	–	–	.625"	50



17-573A

*Application: For steel wheels with 0.625" valve hole;  
Recommended torque at installation: 35-55 in-lbs.*

*\* 10 count bag available. Add "-10" to the part number. Example: 17-573A-10.*

**BRASS VALVES, METRIC**

Part Number	TR Number	Material	(A) Height	(B) Length	Angle	Valve Hole	Bag Qty*
<b>17-41MS-00</b>	V3-20-1	Brass	1.38"	–	–	9.7mm	50
<b>17-60MS-27</b>		Nickel	1.00"	1.19"	27°	9.7mm	50
<b>17-70MS-27</b>	V3-20-5	Brass	1.00"	1.56"	27°	9.7mm	50
<b>17-80MS-27</b>	V3-20-7	Brass	1.00"	2.00"	27°	9.7mm	50
<b>17-90MS-27</b>	V3-20-4	Brass	1.00"	2.38"	27°	9.7mm	50
<b>17-115MS-27</b>	V3-20-6	Brass	1.00"	3.38"	27°	9.7mm	50



17-41MS-00



17-70MS-27 17-80MS-27 17-90MS-27 17-115MS-27

*Application: For aluminum wheels with 9.7mm (0.382"/0.394") valve hole  
and rim thickness of .218"-.330" at valve hole.  
Recommended torque at installation: 80-125 in-lbs.*

*\* 10 count bag available. Add "-10" to the part number. Example: 17-41MS-00-10.*

**NICKEL-PLATED BRASS VALVES**

Part Number	TR Number	Material	(A) Height	(B) Length	Angle	Valve Hole	Bag Qty*
<b>17-509</b>	509	Nickel-plated	0.45"	4.75"	90°	.625"	50
<b>17-510</b>	510	Nickel-plated	0.45"	5.50"	90°	.625"	50
<b>17-511</b>	511	Nickel-plated	0.45"	4.25"	90°	.625"	50

*Application: For aluminum wheels with 0.625" valve hole;  
Recommended torque at installation: 100-125 in-lbs.*

*\* 10 count bag available. Add "-10" to the part number. Example: 17-509-10.*



17-509

17-510

17-511

**Valve Replacement Parts**

**HEAVY TRUCK**

Part Number	TR Number	Description	Bag Qty
<b>17-547</b>	HN-21	Nut for TR 540 Series	10
<b>17-547A</b>	HN-22	Long Nut for TR 540/550 Series	10
<b>17-548</b>	HN-17	Nut for TR 509 Series	10
<b>17-549</b>	RG-60	O-Ring for TR 540 Series	25
<b>17-551</b>		EPDM Grommet for 17-501-OV	10
<b>17-558</b>		Grommet for TR 550 Series	25
<b>17-576</b>	HN-13	Brass Nut for TR 500 Series	10
<b>17-576A</b>	RW-8	Brass Washer for TR 500 Series	10
<b>17-577</b>	RG-15	EPDM Grommet for TR 500 Series	50
<b>17-577G</b>	RG-15	Green Silicone Grommet for TR 500 Series	25
<b>17-577H</b>	RG-15	Red Silicone Grommet for TR 500 Series	25
<b>17-578</b>	RG-46	EPDM Grommet for TR 509 Series	25
<b>17-169T</b>		Grommet Removal Tool for Truck Valves	1



17-547

17-547A

17-548

17-549

17-551



17-558

17-576

17-576A

17-577



17-577G

17-577H

17-578



17-169T

Nickel Plated Brass Valves – METRIC

NICKEL PLATED BRASS VALVES – WITH O-RINGS*							
Part Number	TR Number	Material	(A) Height	(B) Length	Angle	Valve Hole	Bag Qty*
17-542	542	Nickel-plated	1.26"	–	–	9.7mm	50
17-543	543	Nickel-plated	2.31"	–	–	9.7mm	50
17-543C	543C	Nickel-plated	0.93"	1.38"	45°	9.7mm	50
17-543D	543D	Nickel-plated	0.98"	1.38"	60°	9.7mm	50
17-543E	543E	Nickel-plated	0.98"	1.38"	75°	9.7mm	50
17-544	544	Nickel-plated	2.86"	–	–	9.7mm	50
17-544C	544C	Nickel-plated	0.98"	1.94"	45°	9.7mm	50
17-544D	544D	Nickel-plated	0.98"	1.94"	60°	9.7mm	50
17-545	545	Nickel-plated	3.50"	–	–	9.7mm	50
17-545D	545D	Nickel-plated	0.98"	2.60"	60°	9.7mm	50
17-545E	545E	Nickel-plated	0.98"	2.60"	75°	9.7mm	50
17-546V	546	Nickel-plated	4.27"	–	–	9.7mm	50
17-546-36	546-36	Nickel-plated	0.98"	3.35"	36°	9.7mm	50
17-546D	546D	Nickel-plated	0.98"	3.35"	60°	9.7mm	50
17-546E	546E	Nickel-plated	0.98"	3.35"	75°	9.7mm	50
17-547D	547D	Nickel-plated	0.98"	3.78"	60°	9.7mm	50



APPLICATION: For aluminum wheels with 9.7mm (0.382"/0.394") valve hole and rim thickness of .218"-.330" at valve hole.  
Recommended torque at installation: 80-125 in-lbs.

\* 10 count bag available. Add "-10" to the part number. Example: 17-542-10.

NICKEL PLATED BRASS VALVES – WITH GROMMET*							
Part Number	TR Number	Material	(A) Height	(B) Length	Angle	Valve Hole	Bag Qty*
17-552V	552	Nickel-plated	1.26"	–	–	9.7mm	50
17-553V	553	Nickel-plated	2.31"	–	–	9.7mm	50
17-553C	553C	Nickel-plated	0.93"	1.38"	45°	9.7mm	50
17-553D	553D	Nickel-plated	0.98"	1.38"	60°	9.7mm	50
17-553E	553E	Nickel-plated	0.98"	1.38"	75°	9.7mm	50
17-554V	554	Nickel-plated	2.86"	–	–	9.7mm	50
17-554C	554C	Nickel-plated	0.98"	1.94"	45°	9.7mm	50
17-554D	554D	Nickel-plated	0.98"	1.94"	60°	9.7mm	50
17-555V	555	Nickel-plated	3.50"	–	–	9.7mm	50
17-555C	555C	Nickel-plated	0.98"	2.60"	45°	9.7mm	50
17-555D	555D	Nickel-plated	0.98"	2.60"	60°	9.7mm	50
17-555E	555E	Nickel-plated	0.98"	2.60"	75°	9.7mm	50
17-556V	556	Nickel-plated	4.27"	–	–	9.7mm	50
17-556-36	556-36	Nickel-plated	0.98"	3.35"	36°	9.7mm	50
17-556D	556D	Nickel-plated	0.98"	3.35"	60°	9.7mm	50
17-556E	556E	Nickel-plated	0.98"	3.35"	75°	9.7mm	50
17-557D	557D	Nickel-plated	0.98"	3.78"	60°	9.7mm	50



APPLICATION: For aluminum wheels with 9.7mm (0.382"/0.394") valve hole and rim thickness of .218"-.330" at valve hole.  
Recommended torque at installation: 80-125 in-lbs.

\* 10 count bag available. Add "-10" to the part number. Example: 17-552V-10.



## AGRICULTURAL & MISC. VALVE HARDWARE

Every shipment of tire valves is thoroughly inspected to ensure our valves conform to the specifications set by the Tire and Rim Association. Whether you need air tank valves or **agricultural valves** for tube or tubeless tires, you can rely on us to provide only the highest quality valves.

TUBETYPE AGRICULTURAL VALVES, AIR/LIQUID			
Part Number	TR Number	Description	Bag Qty
<b>17-585</b>	218A	3.25" Base with Core Housing	1
<b>17-585/110</b>		4.33" Base (Spud Only)	1



AGRICULTURAL VALVES, AIR/LIQUID			
<i>Recommended Torque at Installation: 45-75 in-lbs. Fits 0.625" Rim Holes</i>			
Part Number	TR Number	Description	Bag Qty
<b>17-586</b>	618A	Tubeless Valve, Straight	50
<b>17-586-10</b>	618A	Tubeless Valve, Straight	10
<b>17-586A</b>	621A	Tubeless Valve with 65° Bend	10
<b>17-586B</b>	622A	Tubeless Valve with 90° Bend	10
<b>17-586C</b>	623A	Tubeless Valve with 65° Bend	10
<b>17-586S</b>		Snap-In Tubeless Valve	10



TRACTOR FRONT WHEEL VALVE			
Part Number	TR Number	Description	Bag Qty
<b>17-591</b>		9/16" Low Profile Valve, Brass	50
<b>17-591C</b>		9/16" Low Profile Valve, Chrome	50

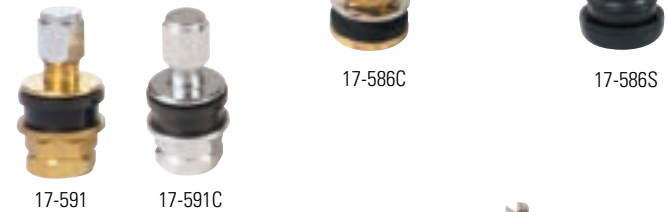

\* 10 count bag available. Add "-10" to the part number.  
Example: 17-591-10.

Includes grommets to fit both 0.453" and 0.625" valve holes.

VALVE REPLACEMENT PARTS, AGRICULTURAL			
Part Number	TR Number	Description	Bag Qty
<b>17-552</b>	RG-7	Grommet for TR 618A Series	10
<b>17-584</b>	LN-10	Nylon Rim Nut	50
<b>17-584B</b>	LN-10	Brass Rim Nut	25
<b>17-587</b>	CH-3	Core Housing	25
<b>17-587A</b>	CH-1	Core Housing, "Old Style"	10
<b>17-587S</b>	-	Core Housing, Short	1



VALVE ACCESSORIES, AGRICULTURAL			
Part Number	TR Number	Description	Bag Qty
<b>17-588</b>	B-6	Valve Hole Reducer Bushing	100
<b>17-590</b>		5/8" Rim Hole Plug	10
<b>17-660</b>		Air/Water Adapter Set (3 Pieces)	1



TANK VALVES			
Part Number	Description	Bag Qty	
<b>17-593</b>	1/8" NPT, Brass	10	
<b>17-593L</b>	1/8" NPT Nickel-Plated, Long	10	
<b>17-594</b>	1/4" NPT, Brass	10	
<b>17-595</b>	1/4" NPT Nickel-Plated	10	



# HALTEC LARGE BORE SOLUTIONS

As the vehicle and tire sizes of off-road, grader, and mining equipment continue to increase, Haltec continues to be a leader in the development and manufacturing of tire valve systems. Whether you need **large bore, super large bore, z-bore, or mega bore valves and accessories**, Haltec offers solutions to meet your needs.



*Any Haltec item not listed is available by special order. Ask for details.*

## Large Bore Valves and Accessories

SINGLE BEND SWIVEL VALVES					
Part Number	TR Number	Description	(A) Height	(B) Length	Bag Qty
17-645-4		90° Swivel Valve	1 5/64" (27.4mm)	4" (101.6mm)	1
17-645-4 1/2	J-4000-4 1/2	90° Swivel Valve	1 5/64" (27.4mm)	4 1/2" (114.3mm)	1
17-645-6	J-4000-6	90° Swivel Valve	1 5/64" (27.4mm)	6" (152.4mm)	1
17-645-9	J-4000-9	90° Swivel Valve	1 5/64" (27.4mm)	9" (228.6mm)	1
17-650	J-650	80° Swivel Valve	1 5/64" (27.4mm)	3 1/8" (79.4mm)	1
17-650C	J-650	J650 with Spud	1 5/64" (27.4mm)	3 1/8" (79.4mm)	1
17-651	J-651	90° Swivel Valve	1 5/64" (27.4mm)	4 11/16" (119mm)	1
17-653	J-653	80° Swivel Valve	1 5/64" (27.4mm)	2 1/2" (62.7mm)	1
17-658	J-658	80° Swivel Valve	1 5/64" (27.4mm)	5 1/2" (139.7mm)	1



17-645 Series



17-650 Series



17-662

17-670

17-670C

STRAIGHT VALVE AND TUBELESS SPUDS					
Part Number	TR Number	Description	(B) Length	Bag Qty	
17-662	SP-2	Tubeless Spud (13/16" Rim Hole)	11/16" (15.8mm)	1	
17-670	J-670-2	Straight Valve	1 1/2" (38.1mm)	1	
17-670C	J-670-3	J-670-2 with Spud	1 5/8" (41.3mm)	1	

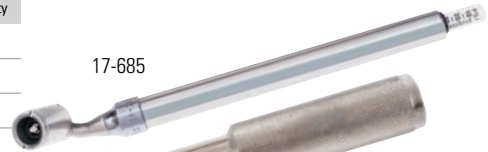

17-685

AIR CHUCKS AND GAUGES					
Part Number	TR Number	Description	Bag Qty		
17-685		Large Bore Swivel Gauge, 10-150 psi	1		
17-687		Lock-On Air Chuck (Long) with 1/4" NPT Female Threads	1		
17-688		Clip-On Air Chuck with 1/4" NPT Female Threads			



17-687



17-688

VALVE TOOLS				
Part Number	TR Number	Description	Bag Qty	
17-694		Large Bore 4-Way Valve Tool	1	
17-697		OTR Tread Depth Gauge	1	
17-698		Large Bore Tube Deflator/Aspirator	1	

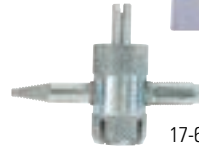

17-694



17-697

CAPS, CORES AND ADAPTERS				
Part Number	TR Number	Description	Bag Qty	
17-589	AD-1	Nut Style Large to Standard Bore Adapter	10	
17-840	C-2	Large Bore Valve Core, Long	1	
17-850	C-2	Large Bore Valve Core, Short	10	
17-856	-	Cap Style Large to Standard Bore Adapter	10	
17-859	VC-6	Large Bore Screwdriver Valve Cap	10	
17-860	VC-7	Large Bore Hex-Head Valve Cap	10	



17-589



17-840



17-850



17-698



17-856



17-859



17-860



## VALVE TOOLS & ACCESSORIES

With the introduction of TPMS and nitrogen inflation systems in recent years, tire and wheel service isn't as simple as it used to be. As we keep up with the changing needs in the aftermarket, 31 Inc. continues to make available the most popular **valve tools and accessories**.

### Valve Caps & Cores

VALVE CAPS & CORES FORTPMS		
Part Number	Description	Box Qty
17-490T	TPMS Nickel-Plated Valve Core, Red	100
17-490TY	TPMS Nickel-Plated Valve Core, Yellow	100
17-492L-1	Long Skirted Black Plastic Cap with Seal	100
17-492T-1	Gray Plastic Cap with Seal	100
17-492LG-1	Long Skirted Green Plastic Cap with Seal	100



17-490T 17-490TY 17-492L-1 17-492T-1 17-492LG-1

VALVE CAPS (TPMS COMPATIBLE)		
Part Number	Description	Box Qty
17-489	Nitrogen ID Ring	100
17-492	VC-8 Black Plastic Cap	100
17-492-1	VC-8 Black Plastic Cap with Seal	100
17-492B-1	VC-8 Blue Plastic Cap with Seal	100
17-492G	VC-8 Green Plastic Cap	100
17-492G-1	VC-8 Green Plastic Cap with Seal	100
17-493BP	Chromed Plastic Cap, Long Skirted	100
17-493NP	Chromed Plastic Cap, Green Top with Seal	100
17-493NPB	Chromed Plastic Cap Blue N <sub>2</sub> Top with Seal	100
17-493P	Chromed Plastic Cap with Seal	100

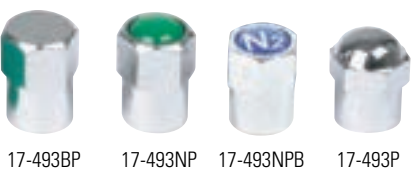

### VALVE CAPS & CORES

**Warning: Do NOT use with TPMS Valve Stems\***

Part Number	Description	Box Qty
17-490	C-1 Short Valve Core	100
17-490HT	C-1 Short Valve Core, High Temperature	100
17-490L	C-1 Long Valve Core, High Temperature	100
17-491D	VC-3 Long Metal Dome Cap with Seal	100
17-491E	Short Metal Dome Cap with Seal	100
17-491S	VC-2 Metal Screwdriver Cap with Seal	100
17-491T	H.D. Metal Dome Cap with Seal	100
17-493	Chrome Hex Cap with Seal	100
17-493B	Long Skirted Chrome Hex Cap with Seal	100
17-493G	Domed Chrome Hex Cap with Seal	100
17-493N	Chrome Hex Cap, Green Top with Seal	100
17-579	Double Seal Valve Cap	-



\* If a brass valve cap is installed on an aluminum valve, corrosion will occur and the cap may not be able to be removed without breaking the valve.

### 17-579 Double Seal Valve Cap

The double seal valve cap is designed for high pressure truck tire service.

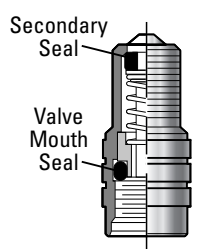

- Inflate directly through sealing cap
- Reduces time and labor
- No lost valve caps

Overall length 7/8"  
Temperature rated seal -40°F to 250°F

17-579

Valve Extensions

PLASTIC, PASSENGER		
Part Number	Description	Bag Qty
17-496	3/4" Plastic	100
17-497	1 1/4" Plastic	100
17-498	1 1/2" Plastic	10
17-499	2" Plastic	50



METAL, PASSENGER		
Part Number	Description	Bag Qty
17-496B	3/4" Metal	25
17-497B	1 1/4" Metal	25
17-557	6" Chrome, 15° bend	1
17-563	1 3/8" Chrome, 135° bend	10
17-564	1 3/8" Chrome, 90° bend	10
17-565	1 3/8" Chrome, 45° bend	10



PLASTIC, TRUCK		
Part Number	Description	Bag Qty
17-581BP	2 1/4" Plastic	10
17-581P	3 3/4" Plastic	10
17-582P	5 1/4" Plastic	10
17-583P	6" Plastic	10



METAL, TRUCK		
Part Number	Description	Bag Qty
17-580	8 1/4" Metal Braided Flexible	6
17-580-14	14" Metal Braided Flexible	1
17-581A	1 13/32" Metal	10
17-581	3 1/16" Metal	10
17-582	5 1/16" Metal	10
17-583	6 1/16" Metal	10



STABILIZER KITS		
Part Number	Description	Bag Qty
17-582-AS1	For Alcoa 22.5" with 2" Center Hole	2
17-582-AS2	For Alcoa 24.5" with 2.19" Off-Center Hole	2



Stabilizer kits include  
2 - 17-582 and  
2 rubber stabilizers.

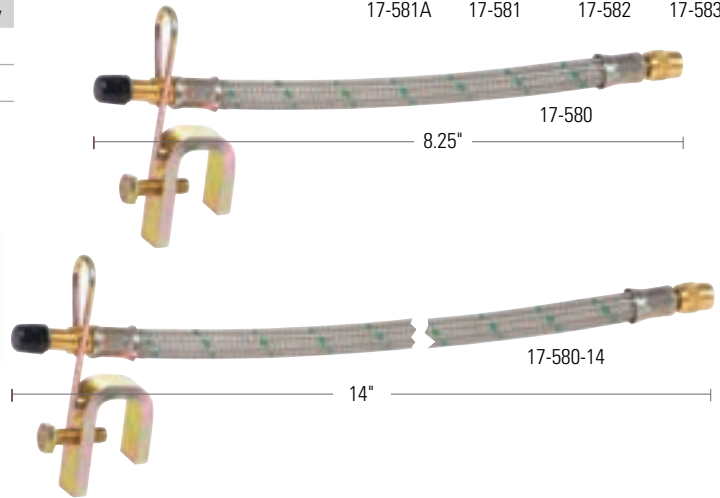

**17-181  
Valve Capper Pro Tool**

Now easier to check inside dual tire. No more lost caps, holds onto caps for removing and replacing. Designed for use with metal and plastic valve caps. Works with DS-1 flow through cap. Length 11 3/4 in.

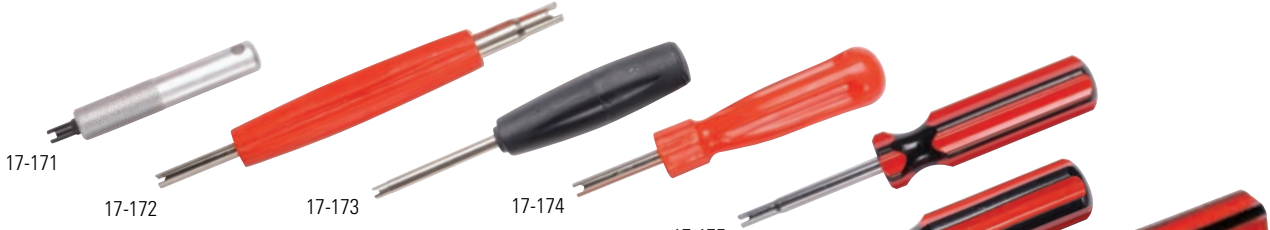

**VALVE CORE REMOVER TOOLS**

Part Number	Description
17-171	Metal Core Tool
17-172	Large and Standard Bore Core Tool
17-173	TPMS Valve Core Torque Tool, 4 in-lbs
17-174	Core Tool
17-175	Screwdriver Handle Core Tool
17-176	Screwdriver Handle Core Tool, Long
17-177	Screwdriver Handle Core Tool, Recessed
17-178	Core Lock Valve Core Tool
17-181	Valve Capper Pro Tool
19-260	Pocket Screwdriver with Core Tool (Bag of 50)

**VALVE TOOLS & ACCESSORIES**

Part Number	Description
17-602	2-Way Valve Tool
17-604	4-Way Valve Tool
17-604B	4-Way Valve Tool, Black Hardened
17-605	Cable-Type Valve Fishing Tool
17-605-24	24" Cable-Type Fishing Tool
17-605C	Chain-Type Valve Fishing Tool
17-608	Tube Deflator Tool

**VALVE INSTALLATION TOOLS**

Part Number	Description
17-606	Valve Installation Tool, Screw-On Type
17-606P	No-Mar Installation Tool with Hardened Steel Rod, Screw-On Type
17-606R	Valve Installation Tool with Rubber Boot
17-606T	Valve Installation Tool with Rubber Block
17-609	Valve Installation Tool, Clamp-On Type
17-609P	Valve Installation Tool, Clamp-On Type
17-610	Pull-a-Stem Valve Installation Tool



## AIR CHUCKS

We offer a large selection of the most popular air chucks for standard bore tire valves. Whether you need "open" chucks for tire changers and inflator gauges or "closed" chucks for live air lines, count on 31 Inc. to have what you need.

PREMIUM DUAL-FOOT AIR CHUCKS		
Part Number	Description	
<b>17-6566BC</b>	Premium Dual-Foot Chuck, Angled	Closed
<b>17-6568BC</b>	Premium Straight-On Tilt Lock Chuck	Closed
<b>17-6568BL</b>	Premium 14" Straight-On Tilt Lock Chuck	Closed



DUAL-FOOT AIR CHUCKS		
Part Number	Description	
<b>17-502</b>	Dual-Foot Chuck, Angled	Closed
<b>17-6566C</b>	Dual-Foot Chuck, Angled	Closed
<b>17-6566FT</b>	Dual-Foot Chuck, Angled	Open
<b>17-6568C</b>	Straight-On Tilt Lock Chuck	Closed
<b>17-6568L</b>	14" Straight-On Tilt Lock Chuck	Closed
<b>17-6568FT</b>	Straight-On Tilt Lock Chuck	Open
<b>17-6569</b>	Dual-Foot Chuck, Straight-On	Closed



### EASY LOCK AIR CHUCK SEALS EASY & LOCKS TIGHT THE FIRST TRY!

- Easy on/off application, custom coupler lock with slide release
- Automatic locking-design chuck
- Hardened steel pins for increased service life
- Improves seal on 17-579 (DS-1) double seal valve caps
- Extended reach for dual wheels
- Available open or closed
- Made in USA



"EASY LOCK" AIR CHUCKS		
Part Number	Description	
<b>17-6301</b>	12" Extended Air Chuck with 180° Reverse Angle	Open
<b>17-6306</b>	12" Extended Air Chuck, Straight	Open
<b>17-6308</b>	8" Chuck with 15° Reverse Angle	Open







Maximum Operating Pressure = 150 psi

BALL FOOT AIR CHUCKS		
Part Number	Description	Type
<b>17-501</b>	Ball Foot Chuck	Closed
<b>17-501N</b>	Nitrogen Ball Foot Chuck	Closed
<b>17-503</b>	Ball Foot Chuck with Clip	Closed
<b>17-503FT</b>	Ball Foot Chuck with Clip	Open
<b>17-5565</b>	Brass Ball Foot Chuck	Closed
<b>17-5567</b>	Brass Ball Foot Chuck with Clip	Closed
<b>17-506</b>	Replacement Clip for Ball Foot Chucks	



EURO STYLE AIR CHUCKS		
Part Number	Description	Type
<b>17-504</b>	Euro Style Chuck with Hose Barb	Open
<b>17-504C</b>	Euro Style Chuck with Hose Barb	Closed
<b>17-504F</b>	Euro Style Chuck with 1/4" NPT	Open
<b>17-504FC</b>	Euro Style Chuck with 1/4" NPT	Closed



LOCK-ON AIR CHUCKS		
Part Number	Description	Type
<b>17-505</b>	Lock-On Chuck	Closed
<b>17-505F</b>	Lock-On Chuck	Open



### Air Chuck Repair Kits

AIR CHUCK REPAIR KITS		
Part Number	Description	Type
<b>17-5565RK</b>	Repair Kit for Ball Foot Chuck	
<b>17-5565RS</b>	Replacement Seal for Ball Foot Chucks	
<b>17-6566RK</b>	Repair Kit for 17-6566C	
<b>17-6568BRK</b>	Repair Kit for 17-6568B	
<b>17-6568RK</b>	Repair Kit for 17-6568C/17-6569	
<b>17-6568RS</b>	Replacement Seal for Dual-Foot Chucks	



AIR BLOW GUNS		
Part Number	Description	Type
<b>17-907</b>	Lever-Type Air Blow Gun with Rubber Tip	
<b>17-907M</b>	Lever-Type Air Blow Gun with Metal Tip	
<b>17-907R</b>	Rubber Tip for 17-907 Blow Gun	

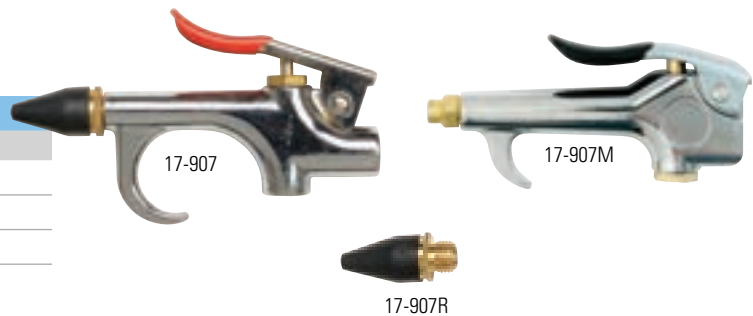

## AIR GAUGES

### PENCIL AIR GAUGES

Part Number	Description	Range
<b>17-900</b>	Air Gauge Counter-Top Display Contains: 5 - 17-909C, 30 - 17-910C, 15 - 17-911C	
<b>17-908C</b>	Air / Liquid Gauge	5 - 45 psi
<b>17-909C</b>	Low Pressure Gauge	1 - 20 psi
<b>17-910C</b>	Standard Gauge	10 - 50 psi
<b>17-910S</b>	Standard Gauge, Straight-On	10 - 50 psi
<b>17-911C</b>	High Pressure Gauge	20 - 120 psi
<b>17-911S</b>	High Pressure Gauge, Straight-On	20 - 120 psi
<b>17-912C</b>	SUV/Light Truck Gauge	10 - 75 psi



17-900

17-910S and  
17-911S

17-908C to  
17-912C

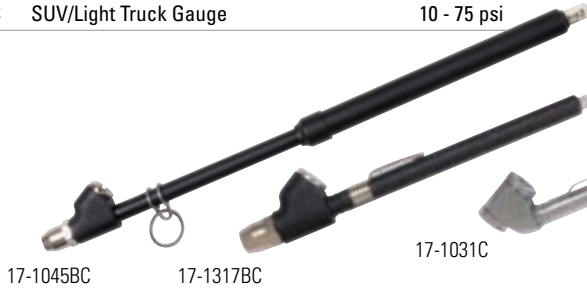

17-1045BC

17-1317BC

17-1031C

### PREMIUM DUAL-FOOT AIR GAUGES

Part Number	Description	Range
<b>17-1045BC</b>	Premium Straight-On, 2-Sided Nylon Bar	10 - 150 psi
<b>17-1317BC</b>	Premium Dual-Foot Gauge, Straight-On	20 - 120 psi



17-1045C

17-1045RCL

17-1047

17-1075

17-1085

17-1313C

17-1317C

### DUAL-FOOT AIR GAUGES

Part Number	Description	Range
<b>17-1031C</b>	Dual-Foot Pocket Gauge, Angled	20 - 120 psi
<b>17-1045C</b>	Straight-On, 2-Sided Metal Bar	10 - 150 psi
<b>17-1045RCL</b>	Recalibratable Gauge, Straight-On, 2-Sided Metal Bar	10 - 150 psi
<b>17-1047</b>	Straight-On, 4-Sided Metal Bar	10 - 150 psi
<b>17-1075</b>	Master Test Gauge, 2-Sided Nylon Bar	10 - 150 psi
<b>17-1085</b>	Straight-On 180° Reverse, 2-Sided Metal Bar	10 - 150 psi
<b>17-1313C</b>	Angled, 2-Sided Metal Bar	10 - 150 psi
<b>17-1317C</b>	Dual-Foot Pocket Gauge, Straight-On	20 - 120 psi

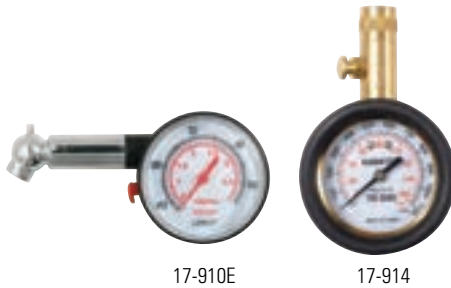

17-910E

17-914

### DIAL AIR GAUGES

Part Number	Description	Range
<b>17-910E</b>	Economy Dial Gauge	0 - 55 psi
<b>17-914</b>	Dial Gauge, Straight-On	0 - 160 psi
<b>17-916</b>	Dial Gauge with 18" Whip Hose	0 - 170 psi
<b>17-917</b>	Dial Gauge with 12" Whip Hose	0 - 160 psi



17-916

17-917

INFLATOR GAUGES		
Part Number	Description	Range
17-920	Inflator Gauge (Sight Glass) with 12" Hose	20 - 120 psi
17-920H	Replacement Hose for 17-920 & 17-922	
17-921	Inflator Gauge (Sight Glass) with 9' Hose	20 - 120 psi
17-922	Inflator Gauge (Nylon Bar) with 12" Hose	20 - 120 psi
17-926	Premium Inflator Gauge with 20" Hose	0 - 138 psi
17-927	Premium Safety Inflator Gauge with 9' Hose	0 - 138 psi
17-935	Digital Inflator Gauge, Rubber Encased	0 - 174 psi
17-935H	Replacement Hose for 17-935	
17-936	Digital Inflator Gauge	0 - 174 psi
17-936H	Replacement Hose for 17-936	

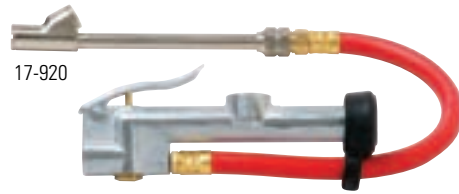

17-920

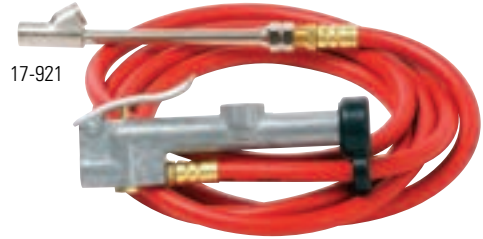

17-921

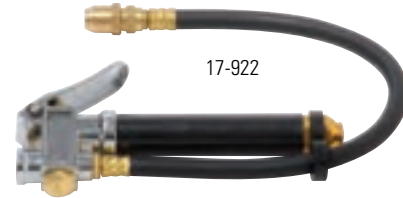

17-922

### 17-926 Premium Inflator Gauge

- 0-138PSI, 1/4" NPT Inlet
- Die-Cast Rugged Body
- 20" Hose with Dual Lock-On Chuck



17-926

### 17-927 Premium Safety Inflator Gauge

- 0-138PSI, 1/4" NPT Inlet
- Die-Cast Rugged Body
- 9' Hose with Lock-On Chuck



17-927

### 17-935 and 17-936 Key Features

- Inflates and deflates
- High inflation and deflation rates
- Clear and easy-to-read digital display with backlight
- PSI, KPA, BAR, KGF units can be selected by the user
- Long-life battery with low battery warning light



17-935

17-936

GAUGES FOR TIRE CHANGERS	
Part Number	Description
17-991	Air Gauge for Coats Rim Clamp Tire Changers, Flange Mount
17-992	Air Gauge for FMC/John Bean and Snap-On
17-993	Replacement Lens for 17-991 and 17-992



17-991



17-992



17-993



## AIR HOSES & ACCESSORIES

### HYBRID AIR HOSE

300 psi max. operating pressure

Part Number	Description	Thread Size
17-941	Professional Grade 50' x 3/8" Hybrid Air Hose Taco Shell Package	1/4" NPT
17-942	50' x 3/8" Hybrid Air Hose	1/4" NPT
17-942T	50' x 3/8" Hybrid Air Hose Taco Shell Package	1/4" NPT



17-941

17-942

17-942T

### RUBBER AIR HOSE

300 psi max. operating pressure

Part Number	Description	Thread Size
17-944	25' x 3/8" Rubber Air Hose	1/4" NPT
17-945	50' x 3/8" Rubber Air Hose	1/4" NPT



17-944

17-945

### RUBBER AIR HOSE - PROFESSIONAL GRADE

300 psi max. operating pressure

Part Number	Description	Thread Size
17-944USA	25' x 3/8" Rubber Air Hose	1/4" NPT
17-944-3/8USA	25' x 3/8" Rubber Air Hose	3/8" NPT
17-945USA	50' x 3/8" Rubber Air Hose	1/4" NPT
17-945-3/8USA	50' x 3/8" Rubber Air Hose	3/8" NPT
17-946USA	25' x 1/2" Rubber Air Hose	3/8" NPT
17-947USA	25' x 1/2" Rubber Air Hose	1/2" NPT
17-948USA	50' x 1/2" Rubber Air Hose	3/8" NPT
17-949USA	50' x 1/2" Rubber Air Hose	1/2" NPT



17-945USA

### PVC AIR HOSE

300 psi max. operating pressure

Part Number	Description	Thread Size
17-966	25' x 3/8" PVC Air Hose	1/4" NPT
17-967	50' x 3/8" PVC Air Hose	1/4" NPT
17-967N	50' x 3/8" Nitrogen PVC Hose	1/4" NPT
17-968	300' x 3/8" Bulk PVC Air Hose	
17-969	50' x 1/2" PVC Air Hose	1/2" NPT
17-970	50' x 1/2" PVC Air Hose	3/8" NPT



17-967

17-967N

17-966

### RECOIL AIR HOSE

200 psi max. operating pressure

Part Number	Description	Thread Size
17-763	12' x 1/4" Recoil Air Hose	1/4" NPT
17-764	25' x 1/4" Recoil Air Hose	1/4" NPT
17-765	50' x 1/4" Recoil Air Hose	1/4" NPT
17-774	25' x 3/8" Recoil Air Hose	1/4" NPT
17-774-3/8	25' x 3/8" Recoil Air Hose	3/8" NPT
17-775	50' x 3/8" Recoil Air Hose	1/4" NPT
17-775-3/8	50' x 3/8" Recoil Air Hose	3/8" NPT
17-775N	50' x 3/8" Nitrogen Recoil Air Hose	1/4" NPT

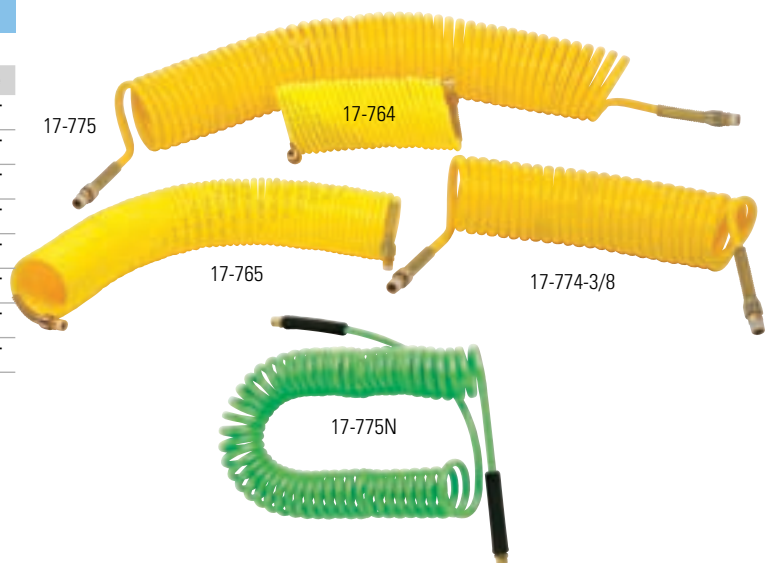

17-775

17-764

17-765

17-774-3/8

17-775N



**REPLACEMENT AIR HOSE FOR TIRE CHANGERS**

*300 psi max. operating pressure*

Part Number	Description
<b>17-990</b>	Coats Hose, 1/4" x 56" (open chuck)
<b>17-990F</b>	FMC Hose, 1/4" x 56" (open chuck)



**17-952  
Hose Reel**

- Heavy-duty all-steel construction hose reel features a corrosion resistant powder coat finish for longer life and durability
- Premium grade 3/8-inch x 50-foot rubber air hose included
- Permits wall, ceiling, or floor mounting
- 4-roller guide arm adjusts to (9) different potential positions



**FERRULES**

Part Number	Description	I.D.	Bag Qty
<b>17-971</b>	Ferrule for 1/4" PVC Hose	0.520"	10
<b>17-972</b>	Ferrule for 3/8" PVC Hose	0.650"	10
<b>17-972R</b>	Ferrule for 3/8" Rubber Hose	0.750"	10
<b>17-977</b>	Ferrule for 1/2" PVC Hose	0.775"	10
<b>17-977R</b>	Ferrule for 1/2" Rubber Hose	0.900"	10



**HOSE BARBS**

Part Number	Description	Bag Qty
<b>17-9735</b>	1/4" Hose Barb, 1/4" Female	10
<b>17-973</b>	1/4" Hose Barb, 1/4" Male	10
<b>17-9731</b>	5/16" Hose Barb, 1/4" Male	10
<b>17-974</b>	3/8" Hose Barb, 1/4" Male	10
<b>17-9743</b>	3/8" Hose Barb, 3/8" Male	10
<b>17-9784</b>	1/2" Hose Barb, 1/4" Male	10
<b>17-978A</b>	1/2" Hose Barb, 3/8" Male	10
<b>17-978</b>	1/2" Hose Barb, 1/2" Male	10



**HOSE SPLICER**

Part Number	Description	Bag Qty
<b>17-975</b>	1/4" Hose Splicer	10
<b>17-9751</b>	5/16" Hose Splicer	10
<b>17-976</b>	3/8" Hose Splicer	10



17-979  
Crimping Die Sizes – .63", .58", .53", .48", .68"

**AIR HOSE CRIMPING TOOL**

Part Number	Description
<b>17-979</b>	Air Hose Crimping Tool

# PREMIUM BRASS COUPLERS



THESE POINTS APPLY TO OUR 1/4" BRASS COUPLERS

### Solid Brass Construction

Purchased from pure grade raw bar-stock and machined to provide consistent quality and the optimum blend of strength, durability, sealing and corrosion resistance.

### 6-Ball Design

Heat treated carbon steel locking balls for superior life and stronger connection strength.

### Nitrile (BunaN) Seal

Superior resistance to oil and temperature changes providing optimal sealing for longer life.

### Stainless Steel Spring

Superior life and corrosion resistance. High tension strength reduces accidental disconnection and increases life under extreme use.

### Disconnection Protection Ring

Machined into body to prevent accidental disconnection under pressure for greater safety and reliability.

## High Flow Couplers

Allow more than twice the amount of airflow to your tool, ensuring your tools will give their maximum torque, maximum RPM, and the bottom line best performance your air system can provide.

- High flow 70CFM (when used with high flow plug)
- Extremely light weight (50% lighter than brass or steel)
- Push-to-connect six ball design
- Heavy-duty T6 aluminum for durability
- Anodized aluminum for extreme corrosion resistance
- Stainless steel balls, springs and valve
- Laser etched for easy identification
- Compatible with other 1/4" Industrial style plugs



**15-7170**  
High Flow Coupler  
PUSH-TO-CONNECT  
1/4" BODY  
1/4" NPT F



**15-7171**  
High Flow Coupler  
PUSH-TO-CONNECT  
1/4" BODY  
1/4" NPT M



**15-7180**  
High Flow Plug  
1/4" BODY  
1/4" NPT F



**15-7181**  
High Flow Plug  
1/4" BODY  
1/4" NPT M

**Industrial Style** is also referred to as MILTON style. It is by far the most popular style used in North America, as was adopted by the US military as their standard pneumatic style per US Military Specification – Mil-C-4109.

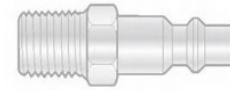

- Usually designated by two thin rings on the sleeve of the coupler.
- Also identified by "I/M" stamped in the hex body.

**6-Ball Design**



1/4" INDUSTRIAL SERIES											
COUPLER						TYPE D	PLUG				
31 Inc. Part Number	Thread Type	Thread Size	Metal Type	Max PSI			31 Inc. Part Number	Thread Type	Thread Size	Metal Type	Max PSI
17-322	Female	1/4"	Brass	300		17-232	Female	1/4"	Steel	300	
17-323	Female	3/8"	Brass	300		17-233	Female	3/8"	Steel	300	
17-332	Male	1/4"	Brass	300		17-222	Male	1/4"	Steel	300	
17-333	Male	3/8"	Brass	300		17-223	Male	3/8"	Steel	300	
17-3222	Female	1/4"	Steel	300							
17-3322	Male	1/4"	Steel	300							



1/4" INDUSTRIAL RECAPPER SERIES											
COUPLER						TYPE D	PLUG				
31 Inc. Part Number	Thread Type	Thread Size	Metal Type	Max PSI			31 Inc. Part Number	Thread Type	Thread Size	Metal Type	Max PSI
17-320	Female	1/4"	Brass	2000		17-246	Female	0.305-32"	Steel	300	



1/4" INDUSTRIAL PUSH-TO-CONNECT SERIES											
COUPLER						TYPE D	PLUG				
31 Inc. Part Number	Thread Type	Thread Size	Metal Type	Max PSI			31 Inc. Part Number	Thread Type	Thread Size	Metal Type	Max PSI
17-322P	Female	1/4"	Steel	300							
17-332P	Male	1/4"	Steel	300							



3/8" INDUSTRIAL SERIES											
COUPLER						TYPE E	PLUG				
31 Inc. Part Number	Thread Type	Thread Size	Metal Type	Max PSI			31 Inc. Part Number	Thread Type	Thread Size	Metal Type	Max PSI
17-324	Female	1/4"	Steel	1000		17-254	Female	1/4"	Steel	300	
17-325	Female	3/8"	Steel	300		17-255	Female	3/8"	Steel	300	
17-334	Male	1/4"	Brass	300		17-256	Male	1/4"	Steel	300	
17-335	Male	3/8"	Steel	300		17-253	Male	3/8"	Steel	300	

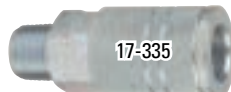

1/2" INDUSTRIAL SERIES											
COUPLER						TYPE H	PLUG				
31 Inc. Part Number	Thread Type	Thread Size	Metal Type	Max PSI			31 Inc. Part Number	Thread Type	Thread Size	Metal Type	Max PSI
17-355	Female	3/8"	Steel	500		17-252	Female	1/2"	Steel	300	
17-356	Female	1/2"	Steel	300							
						17-251	Male	1/2"	Steel	300	

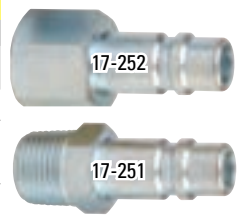

**Automotive Style** also referred to as TRU-FLATE style is the second most popular style, and is preferred in certain areas of North America.

- More popular style for 3/8" body couplers.
- Usually designated by one thin ring on the sleeve of the coupler.
- Also Identified by "T" stamped in the hex body.



1/4" AUTOMOTIVE SERIES										
COUPLER					TYPE C	PLUG				
31 Inc. Part Number	Thread Type	Thread Size	Metal Type	Max PSI		31 Inc. Part Number	Thread Type	Thread Size	Metal Type	Max PSI
17-326	Female	1/4"	Brass	300		17-234	Female	1/4"	Steel	300
17-336	Male	1/4"	Brass	300		17-224	Male	1/4"	Steel	300
17-3262	Male	1/4"	Steel	300						



1/4" RECAPPER SERIES (AUTOMOTIVE SERIES)										
COUPLER					TYPE C	PLUG				
31 Inc. Part Number	Thread Type	Thread Size	Metal Type	Max PSI		31 Inc. Part Number	Thread Type	Thread Size	Metal Type	Max PSI
17-340	Female	1/4"	Steel	300		17-241	Female	0.305-32"	Steel	300
						17-242	Male	1/4" *	Steel	300



\* Has 0.305-32" internal threads

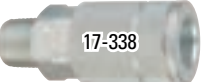
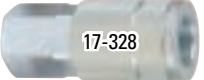
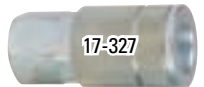

3/8" AUTOMOTIVE SERIES										
COUPLER					TYPE G	PLUG				
31 Inc. Part Number	Thread Type	Thread Size	Metal Type	Max PSI		31 Inc. Part Number	Thread Type	Thread Size	Metal Type	Max PSI
17-327	Female	1/4"	Steel	300		17-235	Female	1/4"	Steel	300
17-328	Female	3/8"	Steel	300		17-236	Female	3/8"	Steel	300
17-337	Male	1/4"	Steel	300	17-225	Male	1/4"	Steel	300	
17-338	Male	3/8"	Steel	300	17-226	Male	3/8"	Steel	300	



1/2" AUTOMOTIVE SERIES										
COUPLER					TYPE F	PLUG				
31 Inc. Part Number	Thread Type	Thread Size	Metal Type	Max PSI		31 Inc. Part Number	Thread Type	Thread Size	Metal Type	Max PSI
17-361	Female	3/8"	Steel	300		17-262	Female	3/8"	Steel	300
17-363	Female	1/2"	Steel	300		17-264	Female	1/2"	Steel	300
17-364	Male	1/2"	Steel	300	17-261	Male	3/8"	Steel	300	
					17-263	Male	1/2"	Steel	300	

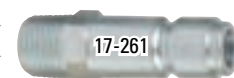



**ARO Style** is the third most popular style, and is preferred in certain areas of North America and Canada.

- Usually designated by one thick ring on the sleeve of the coupler.
- Also identified by "A" stamped in the hex body.

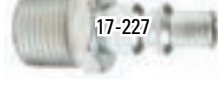

1/4" ARO SERIES										
COUPLER					TYPE B	PLUG				
31 Inc. Part Number	Thread Type	Thread Size	Metal Type	Max PSI		31 Inc. Part Number	Thread Type	Thread Size	Metal Type	Max PSI
17-342	Female	1/4"	Brass	300		17-231	Female	1/4"	Steel	300
17-343	Female	3/8"	Brass	150		17-237	Female	3/8"	Steel	300
17-347	Male	1/4"	Brass	300		17-221	Male	1/4"	Steel	300
17-348	Male	3/8"	Brass	150		17-227	Male	3/8"	Steel	300
17-3421	Female	1/4"	Steel	300						
17-3471	Male	1/4"	Steel	300						



3/8" ARO SERIES										
COUPLER					TYPE B	PLUG				
31 Inc. Part Number	Thread Type	Thread Size	Metal Type	Max PSI		31 Inc. Part Number	Thread Type	Thread Size	Metal Type	Max PSI
17-345	Female	3/8"	Steel	250		17-239	Female	3/8"	Steel	300
17-349	Male	3/8"	Steel	250		17-228	Male	1/4"	Steel	300
						17-229	Male	3/8"	Steel	300



**Lincoln Style** is the fourth most popular style, and is preferred in certain areas of North America and Canada.

- Easily identified by its long, slender body and also identified by one thick ring and one thin ring on the sleeve.



1/4" LINCOLN SERIES										
COUPLER					TYPE A	PLUG				
31 Inc. Part Number	Thread Type	Thread Size	Metal Type	Max PSI		31 Inc. Part Number	Thread Type	Thread Size	Metal Type	Max PSI
17-312	Female	1/4"	Steel	300		17-213	Female	1/4"	Steel	300
17-313	Male	1/4"	Steel	300		17-212	Male	1/4"	Steel	300



**Universal Couplers** can attach to the three most popular style plugs in the North American Market – Industrial, Automotive and ARO.

- Sometimes called 3-Way couplers.
- Also feature "Push-to-Connect" style – meaning user does not have to pull back sleeve to engage.
- Identified by three thin rings in the sleeve and a "U" stamped in the hex body.

1/4" UNIVERSAL SERIES										
COUPLER					Works with 1/4" Aro, Automotive and Industrial Interchange (Types B, C and D) Nipples (Plugs).	PLUG				
31 Inc. Part Number	Thread Type	Thread Size	Metal Type	Max PSI		31 Inc. Part Number	Thread Type	Thread Size	Metal Type	Max PSI
17-452	Female	1/4"	Brass	150						
17-454	Male	1/4"	Brass	150						
17-4521	Female	1/4"	Steel	150						

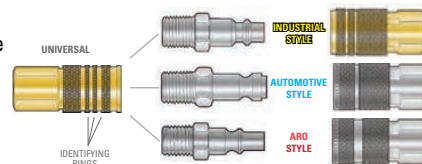
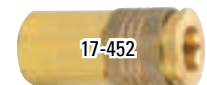

## COUPLER & PLUG CROSSOVER

31 Inc. Part No.	31 Inc. Carded	Amflo Part No.	Camel Part No.	Dill Part No.	Haltec Part No.	Hansen Part No.	Milton Part No.	NAPA Part No.	Rema Part No.	Schrader Part No.	Tech Part No.	Tru-Flate Part No.
17-212	15-7461	CP27	61-550	126	NI-702		791	90-648	2235	3531	VHC91	12-424
17-213	15-7465	CP28	61-551	125	NI-704		792	90-650	2236	3532	VHC92	12-434
17-221	15-7521	CP37	61-528	8891	NI-502	2608	777	90-618	2231	3529	VHC77	12-324
17-222	15-7122	CP21	61-578	110	NI-202	10	727	90-674	2239	5138-11	VHC27	12-224
17-223		CP21-03	61-535			14	733	90-677		5263-11		12-226
17-224	15-7324	CP1	61-538	D-2C	NI-102	21AP25M	783	90-624	2221	3506	VHC83	12-124
17-225	15-7325	CP7	61-480	D-0E		31AP25M	1809	90-685		3519	VHC809	12-602
17-226	15-7326	CP5	61-558	D-2E	NI-108	31AP37M	1807	90-658	2261	3517	VHC807	12-604
17-227		CP37-03				20AP37M		90-619				
17-228						22239						
17-229		CP35	61-162			3804	1877	90-598				
17-231	15-7531	CP38	61-529	8889	NI-504	2609	778	90-620	2232	3530	VHC78	12-334
17-232	15-7132	CP20	61-579	109	NI-204	11	728	90-676	2240	5139-11	VHC28	12-234
17-233		CP20-23	61-107			15	732					12-236
17-234	15-7334	CP2	61-539	D-3C	NI-104	21AP25F	784	90-626	2222	3507	VHC84	12-134
17-235	15-7335	CP8	61-481			31AP25F	1810	90-687		3520	VHC810	12-610
17-236	15-7336	CP6	61-559	D-3E	NI-110	31AP37F	1808	90-660	2262	3518	VHC808	12-612
17-237		CP38-23				20AP37F		90-621				
17-239		CP36				3806	1878	90-599				
17-241		CP12	61-544	D-6C	NI-106		779		2226	3508		
17-242								90-636		3533		
17-246		CP22	61-023				731					
17-251	15-7151	CP17	61-134			54	1857	90-578				12-752
17-252	15-7152	CP18	61-137			55	1858	90-588				12-762
17-253	15-7153	CP25	61-484	122	NI-206	42	1837	90-683		3542		12-526
17-254	15-7154											
17-255	15-7155	CP26	61-485	121	NI-208	43	1838	90-681		3543		12-536
17-256		CP25-02	61-117			40	1839	90-605				12-525
17-261	15-7340	CP9-03	61-474	D-0F			1819		2257	3537		12-702
17-262		CP10-23	61-475				1820	90-691				12-710
17-263	15-7341	CP9	61-568	D-2F	NI-112		1817	90-666	2255	3513	VHC817	12-704
17-264	15-7342	CP10	61-569	D-3F	NI-113		1818	90-668	2256	3514	VHC818	12-712
17-312	15-7430	C28	61-548	123	CO-701		790	90-644	2136	3528	VHC90	13-434
17-313	15-7472	C27	61-486				794	90-645	2135	3527		13-424
17-320						1000						
17-322	15-7150BR	C20	61-573	102	CO-201		715	90-670	2140	5142-12	VHC15	13-234
17-3222	15-7150	C20	61-573	102	CO-201		715	90-670	2140	5142-12	VHC15	13-234
17-322P		C40	61-013		CO-301		755	90-615		5138-12		13-753
17-323		C20-23	61-103			1200	718	90-667		5263-12		13-236
17-324		C26-22	61-112			400	1833	90-632				
17-325	15-7125	C26	61-482	117	CO-204	420	1835	90-680		3541		13-536
17-326	15-7320BR	C2	61-523	D-13	CO-103		785	90-600	2122	3504	VHC85	13-134
17-3262	15-7320	C2	61-523	D-13	CO-103		785	90-600	2122	3504	VHC85	13-134
17-327	15-7327	C8	61-476	D-15C		400	1803	90-686		3521	VHC803	13-610
17-328	15-7328	C6	61-553	D-15	CO-109	420	1805	90-654	2162	3516	VHC805	13-612
17-332	15-7130BR	C21	61-574	103		1100	716	90-672	2139	5141-12		13-224

Continued on next page.

31 Inc. Part No.	31 Inc. Carded	Amflo Part No.	Camel Part No.	Dill Part No.	Haltec Part No.	Hansen Part No.	Milton Part No.	NAPA Part No.	Rema Part No.	Schrader Part No.	Tech Part No.	Tru-Flate Part No.
17-3322	15-7130	C21	61-574	103		1100	716	90-672	2139	5141-12		13-224
17-332P		C41	61-011		CO-303		756	90-617		5139-12		13-754
17-333		C21-03	61-101			1300	719	90-657		5140-12		13-226
17-334		C25-02	61-110			410	1834	90-625				13-525L
17-335	15-7126	C25	61-483	118		430	1836	90-682				13-526
17-336	15-7321BR	C1	61-524	D-12	CO-101		786	90-610	2121	3503		13-124
17-337		C7	61-478			410	1804	90-684				13-602
17-338	15-7338	C5	61-554		CO-107	430	1806	90-656	2161	3515		13-604
17-340		C2R	61-487	D-13R	CO-105		787	90-609	2124	3505		13-136
17-342	15-7510BR	C38	61-526	8888	CO-501		775	90-612	2132	3526	VHC75	13-334
17-3421	15-7510	C38	61-526	8888	CO-501		775	90-612	2132	3526	VHC75	13-334
17-343		C38-23	61-961			B23AS37F		90-603				
17-345		C36	61-161			310	1875	90-597				
17-347	15-7511BR	C37	61-527				776	90-614	2131	3525		13-324
17-3471	15-7511	C37	61-527				776	90-614	2131	3525		13-324
17-348		C37-03				B23AS37M		90-601				
17-349		C35	61-160			310313		90-596				
17-355	15-7157	C10-23				500	1813					
17-356	15-7156	C10	61-563			520	1815	90-662				13-712
17-361		C10-23	61-472				1813	90-690		3516		13-710
17-363	15-7329	C10	61-563	D-17	CO-111		1815	90-662	2156	3512	VHC815	13-712
17-364	15-7339	C9	61-564	D-16	CO-112		1816	90-664	2155	3511		13-705
17-452	15-7052BR	C60	61-488		CO-800	B23AS25F	745	90-639			VHCEZ14	13-511
17-4521	15-7052	C60	61-488		CO-800	B23AS25F	745	90-639			VHCEZ14	13-511
17-454	15-7054BR	C61	61-491		CO-801	B23AS25M	746	90-946				13-509

# Xtra seal<sup>®</sup>

## RETAIL TIRE REPAIR AND SUPPLIES



---

TIRE REPAIR

---

TOOLS

---

AIR ACCESSORIES

---

TPMS

---

VALVE HARDWARE

---

COUPLERS & PLUGS

---



# WE CAN DESIGN THE SET

*that's right for you!*



**We are your  
complete source!**

- Tire Repair
- Tire Gauges
- Valve Hardware
- Air Accessories
- Commercial Tire  
Repair & Supplies



*Let our experienced,  
retail/commercial  
experts design the set  
that's right for you!*



**X<sup>o</sup>tra  
seal<sup>®</sup>**

QUALITY YOU DEPEND ON!  
**THE NAME YOU TRUST!**

## RETAIL DISPLAYS

**Xtra  
seal****15-9825****Floor Spinner Display**

- Prominently display tire repair kits and air accessories
- High impulse activity generates profitable sales
- Contains the fastest moving items in both retail and commercial tire repair and accessories
- Durable display rack is made of high quality steel with ball bearing swivel base
- Comes with peg hooks with flip-scan label holders and header card
- Rack dimensions: 63" x 14.5" x 14.5" (with peg hooks & header card 71.5" x 21" x 21")

*See page 140 for complete listing of contents*

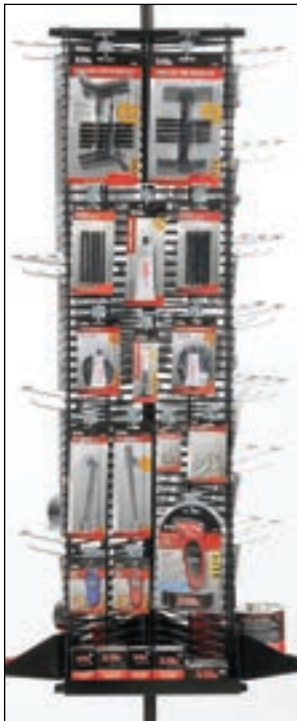

Panel 1



Panel 2



Panel 3

QUALITY YOU DEPEND ON!  
**THE NAME YOU TRUST!**



## REPAIR KITS & PATCHES



**15-012**  
Cold Patch Repair Kit  
3 - 1" x 1" PATCHES  
1 - 1 3/4" x 3" PATCH STRIP



**15-018**  
Bike Patch Kit  
2 MINI ROUND PATCHED  
2 SMALL ROUND PATCHES



**15-019**  
Radial Tire Repair Kit  
2 MEDIUM ROUND PATCHES  
2 SMALL OVAL PATCHES



**15-020**  
All Purpose Patch Kit  
1 MEDIUM ROUND PATCH  
2 MINI ROUND  
2 SMALL ROUND PATCHES



**15-0383**  
Plug-Patch Kit  
PROFESSIONAL SERIES  
1 SMALL & 1 MEDIUM  
COMBINATION REPAIR UNIT



**15-0472**  
Agricultural Tire Repair  
BIAS-PLY TIRE REPAIR  
1 EACH - 4 1/2" & 5 1/2"



**15-0474**  
Agricultural Tire Repair  
BIAS-PLY TIRE REPAIR  
1 EACH - 6 1/2" & 7 1/2"

## REPAIR CHEMICALS



**14-008-1**  
Vulcanizing Cement  
with Hang Tab  
FOR RUBBER REPAIRS  
8 oz. FLAMMABLE



**15-026**  
1 oz. Rubber Cement  
FOR RUBBER REPAIRS  
1 oz. FLAMMABLE



**15-0708**  
Tire Sealant  
SEALS PUNCTURES  
8 oz.



**15-0716**  
Tire Sealant  
SEALS PUNCTURES  
16 oz.



**15-0732**  
Tire Sealant  
SEALS PUNCTURES  
32 oz.

REPAIR KITS & INSERTS



**15-001**  
Tubeless Tire  
Repair Kit  
7 PIECE KIT  
WITH PISTOL-GRIP HANDLES



**15-003**  
Tubeless Tire  
Repair Kit  
7 PIECE KIT  
WITH T-HANDLES



**15-004**  
Truck Tubeless Tire  
Repair Kit  
7 PIECE KIT  
WITH PISTOL-GRIP HANDLES



**15-005**  
Tubeless Tire  
Repair Kit  
7 PIECE KIT  
WITH PISTOL-GRIP HANDLES



**15-011**  
Tubeless Tire  
Repair Kit  
7 PIECE KIT WITH  
SCREWDRIVER-STYLE HANDLES



**15-014**  
Tire Repair Kit  
6 PIECE KIT WITH  
CLOSED-EYE  
INSERTION NEEDLE



**15-016**  
Tire Repair Kit  
5 SAWTOOTH INSERT PLUGS  
WITH SCREWDRIVER-STYLE  
INSERTION NEEDLE



**15-390**  
Premium 4"  
Tire Repair Inserts  
FOR TUBELESS RADIAL  
& BIAS-PLY TIRES  
BULK PACK - 30 INSERTS



**15-394**  
Premium 4"  
Tire Repair Inserts  
FOR TUBELESS RADIAL  
& BIAS-PLY TIRES  
5 INSERTS



**15-045**  
Tire Repair  
Service Case  
PLASTIC CASE



**15-050**  
Deluxe Tire Repair  
Service Kit  
PLASTIC CASE & BONUS TIRE GAUGE



# REPAIR TOOLS & MISCELLANEOUS



**Rasp**



**Split-Eye**



**Closed-Eye**



**Open-Eye**



**15-0211**  
Professional Tire Repair Probe  
2 STAGE KNURLED PROBE WITH PISTOL GRIP



**15-0212**  
Professional Open-Eye Insertion Tool  
PISTOL GRIP

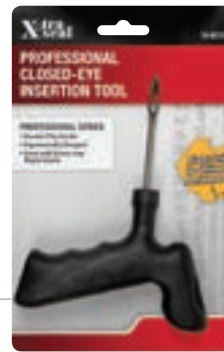

**15-0213**  
Professional Closed-Eye Insertion Tool  
PISTOL GRIP



**15-0216**  
Professional Split-Eye Insertion Tool  
PISTOL GRIP



**15-0308**  
Buffer Sticker  
BUFFING HANDLE/PATCH STITCHER



**15-0314**  
Patch Sticker  
WOOD HANDLE  
BALL BEARING ROLLER



**15-0317**  
Professional Split-Eye Insertion Tool  
HEAVY-DUTY  
CHROME METAL HANDLE



**15-552**  
Yellow Tire Marker  
MARKS TIRES  
FOR ROTATION  
AND REPAIR



**15-553**  
White Tire Marker  
MARKS TIRES  
FOR ROTATION  
AND REPAIR



**15-0320**  
Buffing Wheel  
2 1/2" DIAMETER  
ARBOR HOLE 3/8"



**15-0324**  
Adapter  
3/8" - 24 THREADS  
ADAPTER FOR JACOBS STYLE TOOLS



**15-0378**  
Cotton Tire Swab  
11" LONG

## AIR GAUGES – STANDARD



**15-905**  
Tire Gauge  
STANDARD 2-SIDED BAR  
5-50 PSI



**15-908**  
Tire Gauge  
TRACTOR, FOR LIQUID  
OR AIR FILLED TIRES  
5-45 PSI



**15-909**  
Tire Gauge  
LOW PRESSURE  
1-20 PSI



**15-910**  
Tire Gauge  
DELUXE  
10-50 PSI



**15-9105**  
Tire Gauge  
STANDARD  
STRAIGHT-ON  
10-50 PSI



**15-911**  
Tire Gauge  
HIGH PRESSURE  
20-120 PSI



**15-1031**  
Tire Gauge  
POCKET  
DUAL FOOT  
20-120 PSI



**15-905CD**  
Tire Gauge  
Counter Display  
STANDARD 5-50 PSI



**15-1045**  
Truck Tire  
Gauge  
DUAL FOOT  
STRAIGHT-ON  
10-150 PSI



**15-1045B**  
Premium  
Truck Tire Gauge  
BLACK DUAL FOOT  
STRAIGHT-ON  
10-150 PSI



**15-1313**  
Truck Tire  
Gauge  
DUAL FOOT  
10-150 PSI



**15-1313B**  
Premium  
Truck Tire Gauge  
DUAL FOOT  
10-150 PSI

# AIR GAUGES – DIGITAL & DIAL



**15-1021**  
Digital Tire Gauge  
0-100 PSI



**15-1022**  
Digital Tire Gauge  
SPORT MODEL  
0-100 PSI



**15-1023**  
Digital Tire Gauge  
KEYCHAIN – RED AND BLUE  
MIXED COLORS/PACK  
0-100 PSI



**15-1027**  
Heavy-Duty  
Digital Truck Tire Gauge  
DUAL FOOT  
3-180 PSI



**15-906**  
Dial Tire Gauge  
FOR LARGE AND STANDARD BORE  
WITH BLEEDER  
5-60 PSI



**15-9061**  
Dial Tire Gauge  
FOR STANDARD BORE WITH BLEEDER  
5-60 PSI



**15-951**  
Mini Dial Gauge  
0-60 PSI



**15-952**  
Low Pressure  
Dial Tire Gauge  
0-20 PSI



**15-955**  
Mini Dial Gauge  
5-60 PSI



**15-1075**  
Dial Tire Gauge  
DUAL FOOT  
5-75 PSI



**15-1078**  
Dial Tire Gauge  
HIGH PRESSURE, DUAL FOOT  
0-160 PSI



**AIR GAUGES – INFLATOR**



**15-5920**  
Inflator Gauge  
DUAL FOOT WITH 12" HOSE  
1/4" NPT  
20-120 PSI



**15-5922**  
Inflator Gauge  
12" HOSE  
1/4" NPT  
20-120 PSI



**15-5923**  
Pistol Tire Inflator with Gauge  
12" HOSE DIAL GAUGE  
1/4" NPT  
10-160 PSI



**15-501**  
Air Chuck  
BALL FOOT  
1/4" NPT



**15-503**  
Air Chuck  
LOCK-ON CLOSED  
1/4" NPT

**AIR CHUCKS**



**15-7566**  
Air Chuck  
DUAL FOOT  
CLOSED TYPE  
1/4" NPT



**15-7568**  
Air Chuck  
DUAL FOOT  
STRAIGHT-ON TILT LOCK  
CLOSED TYPE  
1/4" NPT



**15-7568B**  
Air Chuck  
PREMIUM  
STRAIGHT-ON TILT LOCK  
DUAL FOOT CHUCK  
CLOSED TYPE  
1/4" NPT



**15-7569**  
Air Chuck  
DUAL FOOT  
STRAIGHT-ON  
AUTO SHUT OFF  
CLOSED TYPE  
1/4" NPT



**15-5504**  
Air Chuck  
EURO STYLE  
FLOW THRU DESIGN



**15-5505**  
Air Chuck  
LOCK-ON CLOSED  
1/4" NPT



# AIR BLOW GUNS & ACCESSORIES



**15-507**  
Inflator Needles



**15-5601**  
Deluxe Blow Gun Kit  
WITH ASSORTED TIPS

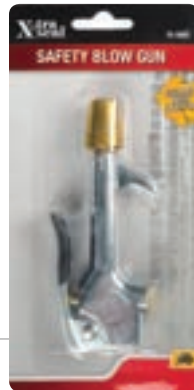

**15-5602**  
Safety Blow Gun  
SAFETY TIP



**15-5603**  
Siphon Blow Gun  
8' PLASTIC TUBING, EXTRACTS FLUIDS  
FROM HARD TO REACH AREAS



**15-5605**  
High Flow Blowgun  
High Flow & RUBBER TIP  
1/4" NPT



**15-5606**  
Blow Gun  
INDUSTRIAL STYLE  
POCKET BLOW GUN



**15-5607**  
Blow Gun  
RUBBER TIP



**15-5608**  
Blow Gun  
4" PISTOL GRIP



**15-5610**  
Blow Gun  
Accessory Kit  
6 PIECE ASSORTED KIT



**15-5611**  
Blow Gun  
AUTOMOTIVE STYLE  
POCKET BLOW GUN



**15-5612**  
Blow Gun  
ARO STYLE  
POCKET BLOW GUN

# AIR BLOW GUNS & ACCESSORIES



**15-5613**  
Clip-on Blow Gun  
CLIPS ON STANDARD AIR CHUCK



**15-5620**  
17 Piece Air Accessory Kit  
COMPATIBLE WITH 1/4" INDUSTRIAL STYLE ACCESSORIES



**15-5318**  
Lead-In Hose  
24" x 3/8" PVC  
SWIVEL LEAD HOSE

# AIR TANK ACCESSORIES



**15-593**  
Tank Valve  
1/8" NPT



**15-594**  
Tank Valve  
1/4" NPT



# AIR HOSE



**15-5324**  
PREMIUM  
Hybrid Whip Hose  
24" LENGTH



**15-5336**  
PREMIUM  
Hybrid Whip Hose  
36" LENGTH

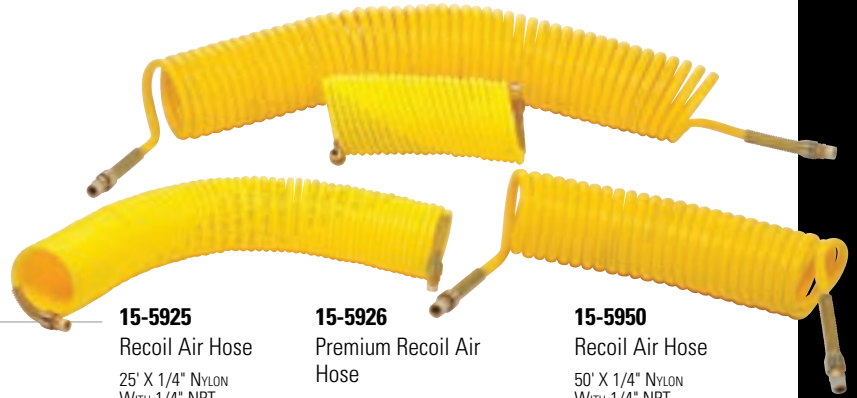

**15-5925**  
Recoil Air Hose  
25' X 1/4" NYLON  
With 1/4" NPT

**15-5926**  
Premium Recoil Air  
Hose  
25' X 1/4" POLYURETHANE  
With 1/4" NPT

**15-5950**  
Recoil Air Hose  
50' X 1/4" NYLON  
With 1/4" NPT

**15-5925-3**  
Recoil Air Hose  
25' x 3/8" NYLON  
With 1/4" NPT

**15-5950-3**  
Recoil Air Hose  
50' X 3/8" NYLON  
With 1/4" NPT



**17-941**  
Hybrid Air Hose  
50' x 3/8"  
PREMIUM HYBRID, 1/4" NPT



**17-942**  
Hybrid Air Hose  
50' x 3/8"  
HYBRID, 1/4" NPT



**17-942T**  
Hybrid Air Hose  
50' x 3/8"  
HYBRID, 1/4" NPT



**17-944**  
Rubber Air Hose  
25' x 3/8"  
1/4" NPT



**17-945**  
Rubber Air Hose  
50' x 3/8"  
1/4" NPT



**17-966**  
PVC Air Hose  
25' x 3/8"  
1/4" NPT



**17-967**  
PVC Air Hose  
50' x 3/8"  
1/4" NPT



# AIR HOSE ACCESSORIES



**15-5730**  
Hose Clamps  
GENERAL PURPOSE



**15-5733**  
Hose Barb  
1/4" BARB  
1/4" NPT F



**15-5734**  
Hose Barb  
1/4" BARB  
1/4" NPT M



**15-5735**  
Hose Barb  
5/16" BARB  
1/4" NPT M



**15-5743**  
Hose Barb  
3/8" BARB  
1/4" NPT F



**15-5744**  
Hose Barb  
3/8" BARB  
1/4" NPT M



**15-5745**  
Hose Barb  
1/2" BARB  
1/4" NPT M



**15-5746**  
Hose Barb  
3/8" BARB  
3/8" NPT M

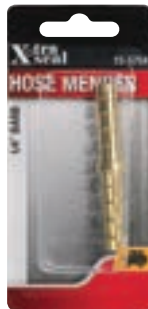

**15-5754**  
Hose Mender  
1/4" BARB



**15-5755**  
Hose Mender  
5/16" BARB

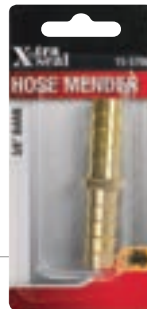

**15-5766**  
Hose Mender  
3/8" BARB

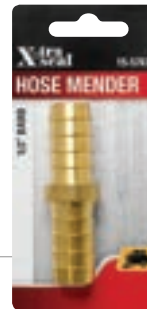

**15-5767**  
Hose Mender  
1/2" BARB







**15-5771**  
Hose Fitting  
REUSABLE FITTING  
1/4" NPT MALE  
(1/4" ID x 19/32" OD)



**15-5772**  
Hose Fitting  
REUSABLE FITTING  
1/4" NPT MALE  
(3/8" ID x 11/16" OD)



**15-5773**  
Hose Fitting  
REUSABLE FITTING  
1/4" NPT MALE  
(3/8" ID x 3/4" OD)



**15-5780**  
Hose Splicer  
REUSABLE  
HOSE SPLICER  
(1/4" ID, 5/8" OD Hose)



**15-5790**  
Swivel Connector



**15-5820**  
Coupling  
1/4" NPT MALE x  
1/4" NPT MALE



**15-5830**  
Coupling  
1/4" NPT FEMALE  
1/4" NPT FEMALE



**15-5840**  
Bushing  
1/4" NPT FEMALE  
3/8" NPT MALE



**15-5850**  
3-in-1 Air Manifold  
1/4" NPT



**15-5860**  
In-Line Regulator  
1/4" NPT



**15-5870**  
In-Line Lubricator  
1/4" NPT



**15-7020**  
Swivel Fitting  
1/4" NPT MALE  
1/4" NPT MALE



**15-7021**  
Swivel Fitting  
1/4" NPT MALE  
1/4" NPT FEMALE

# AIR FILTERS, REGULATORS & LUBRICATORS(FRL)



## REGULATORS, FILTERS & LUBRICATORS 1 per inner pack

Part Number	Description	Size
15-803	Filter and Regulator, Mini with Gauge	1/4" NPT
15-807	Filter and Regulator with Gauge	3/8" - 1/4" NPT
15-808	Filter and Regulator with Gauge	1/2" NPT
15-809	Filter and Regulator with Gauge	3/4" NPT
15-810	Regulator, Mini with Gauge	1/4" NPT
15-813	Regulator, Compact with Gauge	3/8" NPT
15-815	Regulator, Standard with Gauge	1/2" NPT
15-817	Regulator, Standard with Gauge	1" - 3/4" NPT
15-820	Filter, Mini, Manual	1/4" NPT
15-823	Filter, Compact, Manual	3/8" - 1/4" NPT
15-825	Filter, Standard, Manual	1/2" NPT
15-829	Filter, Standard, Manual	1" - 3/4" NPT
15-830	Lubricator, Mini	1/4" NPT
15-833	Lubricator, Compact	3/8" - 1/4" NPT
15-835	Lubricator, Standard	1/2" NPT
15-839	Lubricator, Hi-Flo	1" - 3/4" NPT



**15-803**  
Filter & Regulator  
1/4" NPT Mini w/GAUGE



**15-807**  
Filter & Regulator  
1/4" - 3/8" NPT w/GAUGE



**15-810**  
Regulator, Mini  
1/4" NPT w/GAUGE



**15-813**  
Regulator, Compact  
1/4" - 3/8" NPT w/GAUGE



**15-823**  
Filter, Compact  
1/4" - 3/8" NPT MANUAL



**15-833**  
Lubricator, Compact  
1/4" - 3/8" NPT

## AIR LINE GAUGES 1 per inner pack

Part Number	Description
15-841	Air Line Gauge 0-200 psi 1/8" NPT Back Mount
15-843	Air Line Gauge 0-150 psi 1/4" NPT Back Mount
15-844	Air Line Gauge 0-150 psi 1/4" NPT Bottom Mount
15-845	Air Line Gauge 0-300 psi 1/4" NPT Back Mount
15-846	Air Line Gauge 0-300 psi 1/4" NPT Bottom Mount
15-847	Air Line Gauge 0-60 psi 1/8" NPT Back Mount
15-848	Air Line Gauge 0-60 psi 1/4" NPT Bottom Mount



**15-843**  
Air Line Gauge  
0-150 PSI 1/4" NPT  
BACK MOUNT



**15-844**  
Air Line Gauge  
0-150 PSI 1/4" NPT  
BOTTOM MOUNT



**15-845**  
Airline Gauge  
0-300 PSI 1/4" NPT  
BACK MOUNT

## TPMS TOOLS & ACCESSORIES



### 15-2173 Valve Core Torque Tool

- Durable, precision torque tool with a torque specification of 4 in-lbs
- Use when installing TPMS valve cores to prevent over tightening which can damage the TPMS valve by stripping the valves internal threads or removing the nickel plating of the core resulting in corrosion

**15-2173**  
TPMS Core Tool  
VALVE CORE TORQUE TOOL  
4 IN-LBS



**15-20008**  
Replacement Parts Kit

See page 134 for a comprehensive glossary of TPMS terms



## TPMS VALVE CAPS & CORES



**15-4904**  
TPMS Valve Cores  
NICKEL PLATED ELECTROLESS  
HIGH TEMPERATURE VALVE



**15-4922**  
TPMS Valve Caps  
BLACK PLASTIC SEALING CAP



**15-4923**  
TPMS Valve Caps  
GREEN PLASTIC CAP WITH  
SILICONE SEAL



**15-4925**  
TPMS Valve Caps  
GRAY PLASTIC SEALING CAP



**15-4935**  
TPMS Valve Caps  
CHROMED PLASTIC CAP WITH  
SILICONE SEAL  
WITH GREEN TOP



**15-4932**  
TPMS Valve Caps  
CHROMED PLASTIC SEALING CAP



**15-4927**  
TPMS Valve Caps  
LONG SKIRTED BLACK  
PLASTIC SEALING CAP



**15-4933**  
TPMS Valve Caps  
CHROMED PLASTIC SLEEVES AND CAPS  
FOR 15-20008 VALVE



VALVE HARDWARE VALVES



**15-412**  
Tire Valves  
1" LONG  
FITS .453" RIM HOLE



**15-413**  
Tire Valves  
1 1/4" LONG  
FITS .453" RIM HOLE



**15-4134**  
Tire Valves  
1 1/4" LONG  
WITH CHROME SLEEVES  
FITS .453 RIM HOLE



**15-4142**  
Tire Valves  
1 1/2" LONG  
FITS .453" RIM HOLE



**15-4152**  
Tire Valves  
1 1/4" LONG  
FITS .625" RIM HOLE



**15-418**  
Tire Valves  
2" LONG  
FITS .453" RIM HOLE



**15-4184**  
Tire Valves  
2" TIRE VALVES  
WITH CHROME SLEEVES



**15-4232**  
Tire Valves  
2 1/2" TIRE VALVES



**15-4252**  
Tire Valves  
2" LONG  
FITS .625" RIM HOLE



**15-4600**  
Tire Valves  
1 1/4" HIGH PRESSURE  
FITS .453 RIM HOLE



**15-416**  
Tire Valves  
1 1/2" METAL BOLT-IN  
FITS .453 & .625 RIM HOLE



**15-4559-2**  
Tire Valves  
1" CHROME  
FITS .453 & .625 RIM HOLE



**15-5452**  
Truck Tire Valves  
HEAVY DUTY 3 1/2"  
W/60 DEGREE BEND  
FOR .625 RIM HOLE



**15-572**  
Truck Tire Valves  
HEAVY DUTY 3 3/4"  
FOR .625 RIM HOLE



**15-573**  
Truck Tire Valves  
HEAVY DUTY 4 3/8"  
FOR .625 RIM HOLE





# VALVE HARDWARE VALVE EXTENSIONS



**15-4580**  
Valve Extensions  
METAL BRAIDED DUAL WHEEL  
(2 PER CARD)



**15-496**  
Valve Extensions  
3/4" PLASTIC VALVE EXTENSIONS

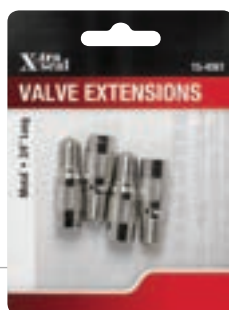

**15-4961**  
Valve Extensions  
3/4" METAL VALVE EXTENSIONS



**15-497**  
Valve Extensions  
1 1/4" PLASTIC VALVE EXTENSIONS



**15-4971**  
Valve Extensions  
1 1/4" METAL VALVE EXTENSIONS



**15-498**  
Valve Extensions  
1 1/2" PLASTIC VALVE EXTENSIONS



VALVE HARDWARE VALVE TOOLS & ACCESSORIES



**15-3174**  
Core Remover  
STANDARD BORE



**15-3602**  
Valve Tool 2-Way  
CORE REMOVER & DEFLATOR



**15-3605**  
Valve Fishing Tool  
CORE REMOVER, DEFLATOR  
VALVE STEM PULLER



**15-3606**  
Valve Installation Tool



**15-3607**  
Tread Depth Gauge  
CHECKS TREAD WEAR WITH CLIP



**15-4660**  
Air/Water Adaptor  
FILLS LIQUID TRACTOR TIRES



**15-4895**  
Valve Adaptor



**15-604**  
Valve Tool 4-Way  
CORE REMOVAL & THREAD REPAIR



**15-6045**  
Valve Core Kit  
4-WAY TOOL WITH CORES

# VALVE HARDWARE VALVE CAPS & CORES



**15-4901**  
Valve Cores  
HIGH TEMPERATURE

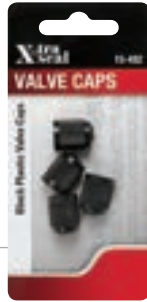

**15-492**  
Valve Caps  
BLACK PLASTIC



**15-4924**  
Valve Caps  
GREEN PLASTIC

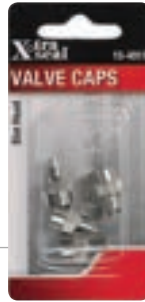

**15-4911**  
Valve Caps  
SLOT HEAD



**15-4915**  
Valve Caps  
HIGH HEAT DOME CAPS



**15-493**  
Valve Caps  
CHROME HEX CAPS



**15-4934**  
Valve Sleeves  
CHROME  
1 1/4" TO 1 1/2" LONG

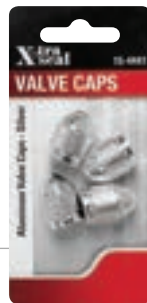

**15-4441**  
Valve Caps  
ALUMINIUM - SILVER

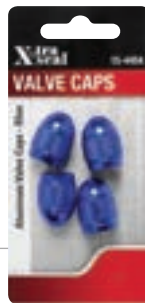

**15-4454**  
Valve Caps  
ALUMINIUM - BLUE



**15-4455**  
Valve Caps  
ALUMINIUM - RED



**15-4458**  
Valve Caps  
ALUMINIUM - BLACK



**15-4032**  
Indicator Valve Caps  
32 PSI



**15-4036**  
Indicator Valve Caps  
36 PSI



**15-4579**  
Heavy Duty Valve Caps  
DOUBLE SEAL HIGH PRESSURE VALVE CAPS





COUPLERS & PLUGS **INDUSTRIAL**



**MATCH STYLE AND TYPE**

Cards are color coded to help identify matching components.

STYLE	TYPE
LINCOLN	A GREEN
ARO	B RED
AUTOMOTIVE	C BLUE
INDUSTRIAL	D YELLOW

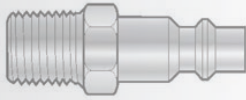

Industrial Style



**15-7110**  
Swivel Plug  
1/4" Body  
1/4" NPT M



**15-7111**  
Swivel Plug  
1/4" Body  
1/4" NPT F



**15-7120**  
Coupler Set  
1/4" Body



**15-7120BR**  
Coupler Set  
1/4" Body  
FML- Plug FML- Plug ML



**15-7122**  
Plug  
1/4" Body  
1/4" NPT M

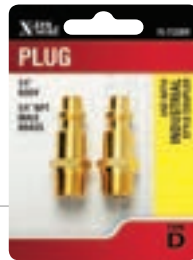

**15-7122BR**  
Plug  
1/4" Body  
1/4" NPT M - BRASS



**15-7124**  
Air Coupler  
1/4" Body  
3/8" NPT F



**15-7130**  
Air Coupler  
1/4" Body  
1/4" NPT M



**15-7130BR**  
Air Coupler  
1/4" Body  
1/4" NPT M - BRASS



**15-7132**  
Plug  
1/4" Body  
1/4" NPT F



**15-7132BR**  
Plug  
1/4" Body  
1/4" NPT F



**15-7150**  
Air Coupler  
1/4" Body  
1/4" NPT F



**15-7150BR**  
Air Coupler  
1/4" Body  
1/4" NPT F BRASS



**15-7125**  
Air Coupler  
3/8" Body  
3/8" NPT F



**15-7125BR**  
Air Coupler  
3/8" Body  
3/8" NPT F



**15-7126**  
Air Coupler  
3/8" Body  
3/8" NPT M



COUPLERS & PLUGS **INDUSTRIAL**



**15-7153**  
Plug  
3/8" Body  
3/8" NPT M



**15-7154**  
Plug  
3/8" Body  
1/4" NPT F



**15-7155**  
Plug  
3/8" Body  
3/8" NPT F



**15-7158**  
Plug  
3/8" Body  
1/4" NPT M



**15-7151**  
Plug  
1/2" Body  
1/2" NPT M



**15-7152**  
Plug  
1/2" Body  
1/2" NPT F



**15-7156**  
Air Coupler  
1/2" Body  
1/2" NPT F



**15-7157**  
Air Coupler  
1/2" Body  
3/8" NPT F

high flow



**15-7170**  
High Flow Coupler  
PUSH TO CONNECT  
1/4" Body  
1/4" NPT F



**15-7171**  
High Flow Coupler  
PUSH TO CONNECT  
1/4" Body  
1/4" NPT M



**15-7180**  
High Flow Plug  
1/4" Body  
1/4" NPT F



**15-7181**  
High Flow Plug  
1/4" Body  
1/4" NPT M

# COUPLERS & PLUGS AUTOMOTIVE



### MATCH STYLE AND TYPE

Cards are color coded to help identify matching components.

STYLE	TYPE
LINCOLN	A GREEN
ARO	B RED
AUTOMOTIVE	C BLUE
INDUSTRIAL	D YELLOW

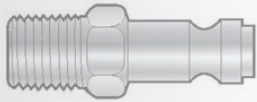

Automotive Style



**15-7306**  
Swivel Plug  
1/4" Body  
1/4" NPT M



**15-7307**  
Swivel Plug  
1/4" Body  
1/4" NPT F



**15-7310**  
Coupler Set  
1/4" Body  
1/4" NPT COUPLER FML -  
PLUG FML - PLUG ML



**15-7310BR**  
Coupler Set  
1/4" Body  
1/4" NPT COUPLER FML - BRASS  
PLUG FML - PLUG ML



**15-7320**  
Air Coupler  
1/4" Body  
1/4" NPT F



**15-7320BR**  
Air Coupler  
1/4" Body  
1/4" NPT F - BRASS



**15-7321**  
Air Coupler  
1/4" Body  
1/4" NPT M



**15-7321BR**  
Air Coupler  
1/4" Body  
1/4" NPT M - BR



**15-7324**  
Plug  
1/4" Body  
1/4" NPT M



**15-7324BR**  
Plug  
1/4" Body  
1/4" NPT M - BRASS



**15-7334**  
Plug  
1/4" Body  
1/4" NPT F



**15-7334BR**  
Plug  
1/4" Body  
1/4" NPT F - BRASS



**15-7325**  
Plug  
3/8" Body  
1/4" NPT M



**15-7326**  
Plug  
3/8" Body  
3/8" NPT M

# COUPLERS & PLUGS AUTOMOTIVE



**15-7327**  
Air Coupler  
3/8" Body  
1/4" NPT F



**15-7327BR**  
Air Coupler  
3/8" Body  
1/4" NPT F - BRASS



**15-7328**  
Air Coupler  
3/8" Body  
3/8" NPT F



**15-7328BR**  
Air Coupler  
3/8" Body  
3/8" NPT F - BRASS



**15-7335**  
Plug  
3/8" Body  
1/4" NPT F



**15-7336**  
Plug  
3/8" Body  
3/8" NPT F



**15-7338**  
Air Coupler  
3/8" Body  
3/8" NPT M



**15-7329**  
Air Coupler  
1/2" Body  
1/2" NPT F



**15-7339**  
Air Coupler  
1/2" Body  
3/8" NPT F



**15-7340**  
Plug  
1/2" Body  
3/8" NPT M



**15-7341**  
Plug  
1/2" Body  
1/2" NPT M



**15-7342**  
Plug  
1/2" Body  
1/2" NPT F

# COUPLERS & PLUGS LINCOLN



### MATCH STYLE AND TYPE

Cards are color coded to help identify matching components.

STYLE	TYPE
LINCOLN	A GREEN
ARO	B RED
AUTOMOTIVE	C BLUE
INDUSTRIAL	D YELLOW

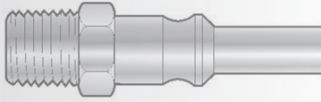

Lincoln Style



**15-7430**  
Air Coupler  
1/4" Body  
1/4" NPT F



**15-7430BR**  
Air Coupler  
1/4" Body  
1/4" NPT F - BRASS



**15-7440**  
Coupler Set  
1/4" Body  
COUPLER FML - PLUG FML -  
PLUG ML 1/4" NPT



**15-7461**  
Plug  
1/4" Body  
1/4" NPT M



**15-7465**  
Plug  
1/4" Body  
1/4" NPT F



**15-7472**  
Air Coupler  
1/4" Body  
1/4" NPT M





# COUPLERS & PLUGS ARO



### MATCH STYLE AND TYPE

Cards are color coded to help identify matching components.

STYLE	TYPE
LINCOLN	A GREEN
ARO	B RED
AUTOMOTIVE	C BLUE
INDUSTRIAL	D YELLOW

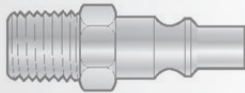

Aro Style



**15-7510**  
Air Coupler  
1/4" Body  
1/4" NPT F



**15-7510BR**  
Air Coupler  
1/4" Body  
1/4" NPT F - BRASS



**15-7511**  
Air Coupler  
1/4" Body  
1/4" NPT M



**15-7511BR**  
Air Coupler  
1/4" Body  
1/4" NPT M - BRASS



**15-7521**  
Plug  
1/4" Body  
1/4" NPT M



**15-7521BR**  
Nipple  
1/4" Body  
1/4" NPT M - BRASS



**15-7530**  
Coupler Set  
1/4" Body  
COUPLER FML- PLUG FML  
PLUG ML 1/4" NPT



**15-7531**  
Nipple  
1/4" Body  
1/4" NPT F



**15-7531BR**  
Nipple  
1/4" Body  
1/4" NPT F - BRASS

# COUPLERS & PLUGS UNIVERSAL

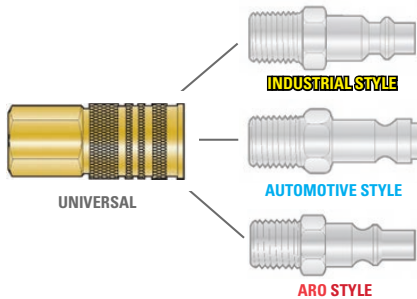

**15-7052**  
Coupler  
PUSH-TO-CONNECT  
1/4" NPT F



**15-7052BR**  
Coupler  
PUSH-TO-CONNECT  
1/4" NPT F - BRASS



**15-7054**  
Coupler  
PUSH-TO-CONNECT  
1/4" NPT M



**15-7054BR**  
Coupler  
PUSH-TO-CONNECT  
1/4" NPT M - BRASS

# COUPLERS & PLUGS INTERCHANGE TABLE



31 RETAIL	31 PRO.	AUTOMOTIVE	CAMEL	MILTON	ACME	NAPA	ITEM DESCRIPTION
<b>UNIVERSAL STYLE 1/4" BODY</b>							
15-7052BR	17-452	13-511					Coupler Push-Connect 1/4" NPT Female
15-7054BR	17-454	13-509	61-241				Coupler Push-Connect 1/4" NPT Male

<b>INDUSTRIAL STYLE</b>							
15-7110		12-229					Plug Swivel Plug, 1/4" Body 1/4" NPT Male
15-7111		12-239					Plug Swivel Plug, 1/4" Body 1/4" NPT Female
15-7120BR		13-201					Set Type D Set, Coupler Female – Plug Female – Plug Male
15-7122	17-222	12-225	61-578	727	A910N-SBL	90674	Coupler Type D, 1/4" Body 1/4" NPT Male
15-7124	17-323	13-236		718		90667	Coupler Type D, 1/4" Body 3/8" NPT Female
15-7125BR		13-537	61-482	1835	A940B-BL	90680	Coupler Type E, 3/8" Body 3/8" NPT Female
15-7126		13-527	61-483	1836		90682	Coupler Type E, 3/8" Body 3/8" NPT Male
15-7130BR	17-332	13-225	61-574	716	A938B-BL	90672	Coupler Type D, 1/4" Body 1/4" NPT Male
15-7132	17-232	12-235	61-579	726	A911N-SBL	90676	Plug Type D, 1/4" Body 1/4" NPT Female
15-7150BR	17-322	13-235	61-573	715	A937B-BL	90670	Coupler Type D, 1/4" Body 1/4" NPT Female
15-7151	17-251	12-752	61-134	1857		90578	Plug Type H, 1/2" Body 1/2" NPT Male
15-7152	17-252	12-762	61-137	1858		90588	Plug Type H, 1/2" Body 1/2" NPT Female
15-7153	17-253	12-527	61-484	1837	A940N-SBL	90683	Plug Type E, 3/8" Body 3/8" NPT Male
15-7154		12-535		1840		90606	Plug Type E Plug, 3/8" Body 1/4" NPT Female
15-7155	17-255	12-537	61-485	1836		90681	Plug Type E, 3/8" Body 3/8" NPT Female
15-7156	17-356	13-713	61-563	1815		90631	Coupler Type H, 1/2" Body 1/2" NPT Female
15-7157	17-355		61-472			90690	Coupler Type H, 1/2" Body 3/8" NPT Female

<b>AUTOMOTIVE STYLE</b>							
15-7306		12-127					Plug Swivel Plug, 1/4" Body 1/4" NPT Male
15-7307		12-137					Plug Swivel Plug, 1/4" Body 1/4" NPT Female
15-7310BR		13-101					Set Type C, Set, Coupler FML – Plug Female – Plug Male
15-7320BR	17-326	13-135	61-523	785	A925B-BL	90600	Coupler Type C, 1/4" Body 1/4" NPT Female
15-7321BR	17-336	13-125	61-524	786	A928N-SBL	90610	Coupler Type C, 1/4" Body 1/4" NPT Male
15-7324	17-224	12-125	61-538	783	A929N-SBL	90624	Plug Type C, 1/4" Body 1/4" NPT Male
15-7325	17-225	12-603	61-480	1809	A944N	90685	Plug Type G, 3/8" Body 1/4" NPT Male
15-7326	17-226	12-605	61-558	1807	A940N	90658	Plug Type G, 3/8" Body 3/8" NPT Male
15-7327BR		13-611	61-476	1803	A944B	90686	Coupler Type G, 3/8" Body 1/4" NPT Female
15-7328BR	17-328	13-613	61-553	1805	A940B	90654	Coupler Type G, 3/8" Body 3/8" NPT Female
15-7329	17-363	13-713	61-563	1815	A942B	90631	Coupler Type G, 1/2" Body 1/2" NPT Female
15-7334	17-234	12-135	61-539	784	A929N	90626	Plug Type C, 1/4" Body 1/4" NPT Female
15-7335	17-235	12-610	61-481	1810	A945N	90687	Plug Type G, 3/8" Body 1/4" NPT Female
15-7336	17-236	12-612	61-559	1808	A941N	90660	Plug Type G, 3/8" Body 3/8" NPT Female
15-7338	17-338	13-604	61-554	1806		90656	Coupler Type G, 3/8" Body 3/8" NPT Male
15-7339	17-364	13-705	61-564	1816		90627	Coupler Type F, 1/2" Body 1/2" NPT Male
15-7340	17-261	12-702	61-474	1819		90689	Plug Type G, 1/2" Body 3/8" NPT Male
15-7341	17-263	12-705	61-568	1817	A942N	90666	Plug Type F, 1/2" Body 1/2" NPT Male
15-7342	17-264	12-713	61-569	1818	A943N	90668	Plug Type F, 1/2" Body 1/2" NPT Female

<b>LINCOLN STYLE 1/4" BODY</b>							
15-7430	17-312	13-435	61-548	790	A935B-BL	90644	Coupler Type A, Long, 1/4" Body 1/4" NPT Female
15-7440		13-401					Set Type A, Long, 1/4" Set
15-7461	17-212	12-425	61-550	791	A933N-SBL	90648	Plug Type A, Long, 1/4" Body 1/4" NPT Male
15-7465	17-213	12-435	61-551	792	A934N-SBL	90650	Plug Type A, Long, 1/4" Body 1/4" NPT Female
15-7472	17-313	13-425	61-486	794	A935B-BL	90645	Coupler Type A, Long, 1/4" Body 1/4" NPT Male

<b>ARO STYLE 1/4" BODY</b>							
15-7510BR	17-342	13-335	61-526	775	A918B-BL	90612	Coupler Type B, 1/4" Body 1/4" NPT Female
15-7511BR	17-347	13-325	61-527	776	A919B-BL	90614	Coupler Type B, 1/4" Body 1/4" NPT Male
15-7521	17-221	12-325	61-528	777	A914N-SBL	90618	Plug Type B, 1/4" Body 1/4" NPT Male
15-7530BR		13-301					Set Type B, Set
15-7531	17-231	12-335	61-529	778	A916N-SBL	90620	Plug Type B, 1/4" Body 1/4" NPT Female

# Xtra Seal<sup>®</sup>

TIRE REPAIR





**Items manufactured by 31 Inc.**

XtraSeal tire repair materials are guaranteed for fitness and merchantability. No returns will be accepted for items that are defective due to misuse or improper storage of repair materials.

**Items distributed but not manufactured by 31 Inc.**

31 Incorporated, manufacturers of XtraSeal tire repair, makes no guarantee or other warranty, express or implied, of goods sold or distributed hereunder, or of their merchantability, fitness, or suitability for a particular purpose or condition. 31 Inc. warrants that it has made no alteration or other change to the product manufactured by others and distributed by 31 Inc., and that the original manufacturer's warranties, if any, are the only warranties applicable to the goods. 31 Inc. shall not be responsible or liable for any claim, loss, damage, liability, or expense of any kind or nature, including, but not limited to, special, incidental, or consequential damages or loss of profits, whether actual or anticipated, caused directly or indirectly by the goods sold.

**PRODUCT INFORMATION****Recommendations for Storage of Repair Materials**

XtraSeal tire repair materials should be stored in an area with a maximum ambient temperature of 80°F (27°C) and a maximum humidity of 75%. If these conditions are exceeded, use an air conditioned storage room at 65°F (18°C) for best results. All materials should be stored in a clean, dry area and surface contamination should be prevented. Always rotate stock so that the oldest materials are consumed first.

**Technical Data for XtraSeal Tire Repair Materials****REPAIR UNITS (PATCHES)****Physical Properties Face Gum (Gray, Blue, & Black):**

Tensile:	2800 psi
300% Modulus:	1100 psi
Elongation:	550%
Hardness, Shore A:	32
Shelf Life:	

**Rheometer @ 310°F (154°C):**

Max. Torque:	12.64 - 13.20
Min. Torque:	06.58 - 07.10
Scorch Time:	02.90 - 03.37
T-90:	10.00 - 10.62

24 months if stored at 65°F (18°C) and avoiding direct sunlight  
18 months if stored at "normal room temperatures" (Max. 80°F (27°C))

**VULCANIZING GUM AND PENNY PATCHES****Physical Properties:**

15' motor @ 280°F (138°C):	
Tensile:	3260 psi
300% Modulus:	780 psi
Elongation:	650%
Hardness, Shore A:	50

**Rheometer @ 300°F (149°C):**

30' motor, 100 range, 3° arc:	
Max. Torque:	41.40
Min. Torque:	07.90
Scorch T-2:	01.32
T-80:	08.60
T-90:	10.75

Shelf Life:  
6 months if stored at 65°F (18°C) and avoiding direct sunlight  
3 months if stored at "normal room temperatures" (Max. 80°F (27°C))

**CHEMICALS****Physical Properties:**

Cure Rates of Cements (Using Xtra Seal repair units):

Chemical Cure (Cold Cure):	72 - 96 hours @ 70°F (21°C)
Heat Cure:	20 minutes @ 300°F (149°C)

Two-Way Cure:

Chemical Cure:	36 - 48 hours @ 70°F (21°C) to 100°F (38°C)
Heat Cure:	20 minutes @ 300°F (149°C)

Shelf Life:

Cement and Bead Sealer:  
24 months if stored at 65°F (18°C) and avoiding direct sunlight  
18 months if stored at "normal room temperatures" (Max. 80°F (27°C))

Buffing Solution:  
36 months if stored at 65°F (18°C) and avoiding direct sunlight  
36 months if stored at "normal room temperatures" (Max. 80°F (27°C))

Inner Liner Sealer:  
24 months if stored at 65°F (18°C) and avoiding direct sunlight  
18 months if stored at "normal room temperatures" (Max. 80°F (27°C))



## Puncture Repair

An injury in the tread (crown) area only (see diagram below) caused by a small, sharp object penetrating the innerliner of the tire. The injury can be a maximum of 1/4" (6mm) in passenger tires and 3/8" (10mm) in light and medium truck tires. (See page 126 for puncture repair procedures.)

## Spot Repair

A rubber only repair that penetrates less than 25% of the body plies. An area to be spot repaired must not exhibit any cord damage except in the case of bias ply tires which may have up to 25% of the cord plies injured.

## Reinforcement Repair

An injury which penetrates between 25% and up to 75% of the body plies. A cord reinforced repair unit is required on the innerliner of the tire.

## Section Repair

An injury that penetrates 75% or more of the body plies and exceeds the puncture repair limits. (See page 129 for section repair procedures.)

## Non-Repairable Bead Area+

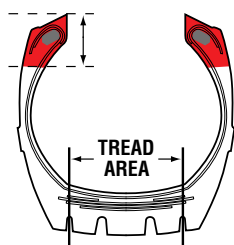

MEASURE FROM TOE OF BEAD DOWN INNERLINER.

+ Reprinted with permission of ITRA

## SECTION REPAIR LIMITS FOR RADIAL TIRES

TIRE SIZE	CROWN LIMITS	SIDEWALL LIMITS	
<b>PASSENGER</b>			
P195R and Smaller	1/2" (13mm)	3/8" (9mm)	x 2" (50mm) or
		3/4" (19mm)	x 1 1/2" (38mm)
P205R and Larger	3/4" (19mm)	3/8" (9mm)	x 2 3/4" (70mm) or
		3/4" (19mm)	x 2" (50mm)
<b>LIGHT TRUCK</b>			
	1" (25mm)	3/8" (9mm)	x 3 1/8" (80mm) or
		1" (25mm)	x 2" (50mm)
<b>TRUCK</b>			
8.25R - 14.00R	1 1/2" (38mm)	3/4" (19mm)	x 5 1/8" (130mm) or
		1 1/4" (32mm)	x 4" (102mm) or
		1 1/2" (38mm)	x 3 1/8" (80mm)

\* Wider repairs must be shorter in length

## SECTION REPAIR LIMITS FOR BIAS PLY TIRES

PLY RATING	CROWN LIMITS	SIDEWALL LIMITS
<b>HIGHWAY SERVICE DRIVE OR TRAILER APPLICATIONS</b>		
Up to 8	1" (25mm)	1" (25mm)
10-14	2" (51mm)	1" (25mm)
16-20	2 1/2" (64mm)	1 1/4" (32mm)
<b>LOCAL SERVICE TRAILER OR P&amp;D APPLICATIONS</b>		
Up to 8	2" (51mm)	1 1/2" (38mm)
10-14	3" (76mm)	1 1/2" (38mm)
16-20	3 1/2" (89mm)	1 3/4" (45mm)

## NON-REPAIRABLE BEAD AREA

TIRE TYPE (BIAS OR RADIAL)	TIRE CROSS SECTION	NON-REPAIRABLE BEAD AREA*
Passenger	All	1 1/2" (38mm)
Light & Medium Truck	Up to 7.5	3" (76mm)
Tube Type	8.25 and above	3 1/2" (89mm)
Light & Medium Truck	Up to 8.8	3" (76mm)
Tubeless	9 and above	3 1/2" (89mm)

\*Rubber and spot repair only in this area. Repair to body ply and/or bead structure in this area is not permitted.

# PUNCTURE REPAIR PROCEDURES INDUSTRY STANDARD PROCEDURES



## NON-REPAIRABLE CONDITIONS\*

Prior to repairing any tire, a careful inspection should be conducted using a grazing light method on both the inside and outside of the tire. According to the "Industry Standards for Tire Repairing", any tire exhibiting the following conditions should not be accepted for repair.

### EXTERNAL

- Exposed cords beyond repairable limits
- Separations beyond repairable limits
- Broken belts
- Excessive oxidation (weather checking) extending to the body plies
- Damage which exceeds the size of a repairable injury or requires the repairs to overlap in radial tires or that are in the same quadrant in bias tires
- Broken or kinked beads
- Damaged bead exposing bead wire
- Injuries beyond the repairable limits
- Tire with less than 2/32" (2mm) nonskid remaining unless retreading is planned. (Some states may require a thicker tread for a tire to remain in service.)
- Previously installed repairs found to be defective and unrepairable
- Radial tires with rust or corrosion beyond repairable limits

### INTERNAL

- Injuries beyond repairable limits
- Porous or loose liners
- Open liner splices beyond repairable limits
- Loose cords on the inside ply or evidence of having been run underinflated or overloaded
- Injury to the ply cord beyond repairable limits

+ Reprinted with permission of ITRA

## TIRE INSPECTION

### EXTERNAL EXAMINATION

1. Carefully remove the wheel from the vehicle following industry recommended practices.
2. Inflate the tire to the manufacturer's recommended operating pressure (found on the sidewall of the tire).
3. Immerse the tire in a test tank to find the damaging leak. In some cases there may be a high pressure leak (one which has its greatest effect when under the full load of the vehicle) and it may be necessary to use leak detector to find the damaging object. Be certain to inspect for the possibility of more than one leak.

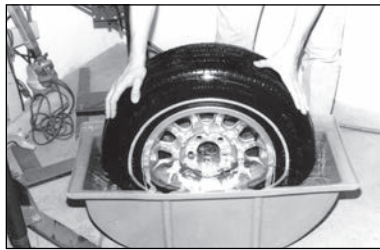

4. Review the non-repairable external conditions above. If the tire has been determined to be repairable, mark the location of the injury on the outside of the tire using a tire marking crayon. If you have any doubts as to the repairability of the tire, do not proceed with the repair.

### INTERNAL EXAMINATION

5. Demount the tire from the wheel and place it on the floor in front of you.
6. Review the non-repairable external conditions above. If the tire has been determined to be repairable, mark the location of the injury on the inside of the tire using a tire marking crayon.
7. Remove the object causing the injury and carefully probe the injury to make sure it is 1/4" or less in diameter in passenger tires and 3/8" or less in light and medium truck tires. If these limits are exceeded, take the tire to a full service repair facility to be considered for section repair.
8. Using a probe, push it into the injury from the outside of the tire until the probe extends 1/4" through the innerliner. Be careful not to create a new hole.
9. With the probe extending through the injury channel and the injury at the 12 o'clock position, place the Patch-Plug Gauge across the tread next to the probe, with the center of the gauge placed at the center point of the injury.
10. If the shaft of the probe is within the gray area (25° or less), a one-piece repair may be used (patch-plug combination unit).
11. If the shaft of the probe is within the red area (greater than 25°), a two-piece repair is required (separate repair unit and insert).
12. Place the tire on a spreader with the injury in the 4 or 8 o'clock position. Do NOT spread the beads too far, as this will distort the final repair.
13. For remaining **one-piece repair procedures** follow steps on page 127.  
For remaining **two-piece repair procedures** follow the steps beginning on page 128.

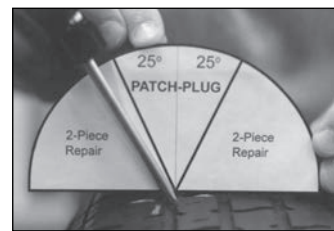
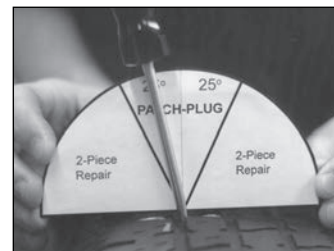

## ONE-PIECE REPAIR PROCEDURES

### INJURY PREPARATION

13. Once the size of the injury has been determined, select the appropriate repair material based on the size of the injury and the type of tire being repaired. Center the patch head over the injury on the inside of the tire and outline an area 1/4" larger than the patch to define the repair area.
14. Using pre-buff rubber cleaner and an innerliner scraper, thoroughly clean the outlined area, removing all mold lubricants, dirt and debris.
15. Using a low speed buffer operating at no more than 5,000 rpm, buff the outlined area to an even, velvety RMA #1 textured finish (see below). Be careful not to buff through the innerliner and expose the cord body plies and expose the cord body plies of the tire.
16. Using a 500 rpm low speed air drill and the appropriate carbide cutter, clear and prepare the injury channel by drilling it 3 times from the inside of the tire and then 3 times from the outside of the tire. This will clear away any damaged cables and prepares the injury channel to receive the vulcanizing insert (stem portion of the repair unit). Vacuum away any buffing debris.
17. Using a cement dipped probe, coat the wall of the injury channel with chemical vulcanizing cement. Using the brush applicator, apply cement to the prepared area of the innerliner in a stippling motion being careful not to puddle the cement. Allow the cement to dry thoroughly before installing the repair unit.

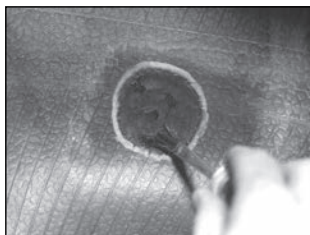
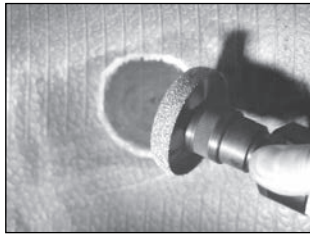
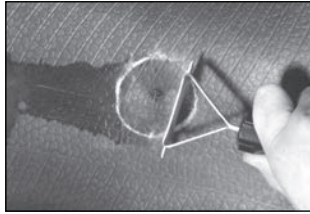

### REPAIR UNIT APPLICATION

18. Relax the tire beads to their normal position. Remove the protective covering from the patch head and stem portions of the repair unit being careful not to touch the gum surfaces of the patch or stem.
19. Place a drop of cement at the leading edge of the stem portion of the repair unit being careful not to puddle. This lubricates the repair unit as it is pulled through the injury channel.
20. Insert the lead wire into the injury channel from the inside of the tire and pull it from the outside of the tire with a pair of pliers. Pull the repair unit steadily from the outside of the tire until the patch head is seated. Do not dimple the patch head by pulling too far.

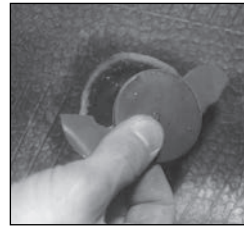

21. Using a roller sticher, stitch the patch down firmly to the innerliner by working from the center outward making sure to remove all trapped air.
22. Keeping the stem in a relaxed position, cut the stem about 1/8" above the tread surface of the tire. Do not pull the stem while cutting.

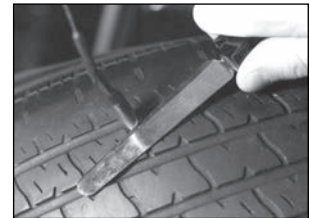

### FINISHING THE REPAIR

23. Remount and inflate the tire following industry recommended procedures.
24. Carefully inspect the repair for leaks and the tire for additional leaks or damage using the tire manufacturer or RMA guidelines. If all inspection criteria are met and no leaks are detected, the tire is ready to be put back into service.

### RMA BUFFING TEXTURES



RMA #1

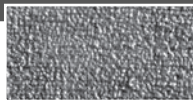

RMA #2



RMA #3

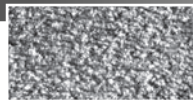

RMA #4



RMA #5

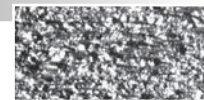

RMA #6



## TWO-PIECE REPAIR PROCEDURES

### INJURY PREPARATION

13. Once the size of the injury has been determined, select the appropriate repair material based on the size of the injury and the type of tire being repaired.
14. Using a 500 rpm low speed air drill and the appropriate carbide cutter, clear and prepare the injury channel by drilling it 3 times from the inside of the tire and then 3 times from the outside of the tire. This will clear away any damaged cables and prepares the injury channel to receive the vulcanizing insert. Vacuum away any buffing debris.
15. Using a cement dipped probe, coat the wall of the injury channel with chemical vulcanizing cement and allow the cement to dry thoroughly.

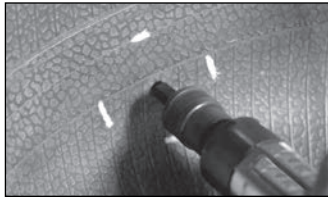

### INSTALLING THE VULCANIZING INSERT

16. Place a drop of cement on the leading edge of the lead wire insert.
17. Insert the lead-wire into the injury channel from the inside of the tire and pull it from the outside of the tire with a pair of pliers until the body of the insert is centered in the injury channel.
18. Using a flexible skiving knife, cut the insert just above the inner liner of the tire.

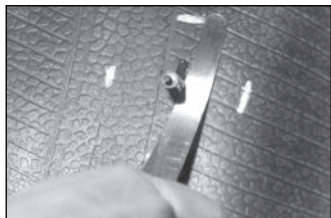
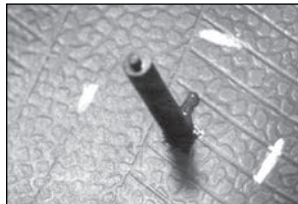

### INSTALLING THE REPAIR UNIT

19. Center the repair unit over the injury on the inside of the tire and outline an area 1/4" larger than the patch to define the repair area.



20. Using pre-buff rubber cleaner and an inner liner scraper, thoroughly clean the outlined area, removing all mold lubricants, dirt and debris.
21. Using a low speed buffer at no more than 5,000 rpm, buff the outlined area to an even, velvety RMA #1 textured finish (see bottom of page 127). Be careful not to buff through the innerliner and expose the cord body plies of the tire. Vacuum away any buffing debris.
22. Using the brush applicator in a stippling motion, apply chemical vulcanizing cement to the prepared area of the inner liner being careful not to puddle the cement. Allow the cement to dry thoroughly before installing the repair unit.
23. Relax the tire beads to their normal position. Remove the protective backing from the repair unit being careful not to touch the gum surface.
24. Place it on the inner liner centered over the insert.

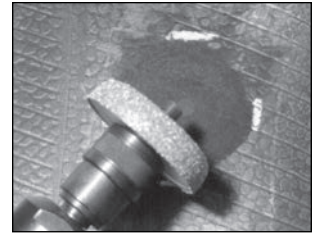
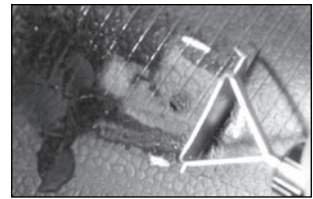

25. Using a roller stitcher, stitch the repair unit down firmly to the tire inner liner by working from the center outward making sure to remove all trapped air.

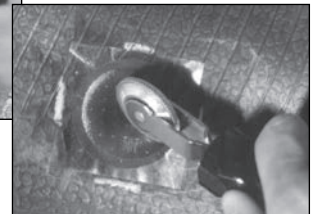
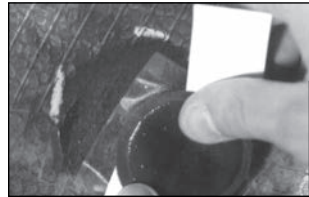

### FINISHING THE REPAIR

26. Keeping the lead-wire insert in a relaxed position, cut the stem about 1/8" above the tread surface of the tire. Do not pull the stem while cutting.
27. Remount and inflate the tire following industry recommended procedures.
28. Carefully inspect the repair for leaks and the tire for additional leaks or damage using the tire manufacturer or RMA guidelines. If all inspection criteria are met and no leaks are detected, the tire is ready to be put back into service.





## INDUSTRY STANDARD SECTION REPAIR PROCEDURES

### INITIAL TIRE INSPECTION

1. An injury that penetrates 75% or more of the body plies and exceeds puncture repair limits requires a section repair. DO NOT attempt to repair this type of damage with nail hole repair units. Demount the tire from the wheel and locate the injury.
2. Remove any injuring object and make a careful visual inspection to determine the size, angle, and extent of the injury. Use a probing awl to probe for unseen internal damage. Determine whether the injury is within repairable limits. (See page 125 for section repair limits and page 126 for non-repairable conditions.)

### FILLING THE INJURY AREA

#### Preparing the Outside of the Tire

3. Using a low speed buffer and a carbide cutter, begin removing all damaged rubber, both inside and outside the tire, and steel cord in the injury area. All broken cords and loose strands of cable must be removed leaving only solid, undamaged rubber at the sides of the opening. If in the tread area, use an appropriate buffing wheel to buff at a 45° angle down to the cord and 90° through the cord.
4. Using a high speed buffer with a pencil stone, polish the exposed cord ends being careful not to scorch the rubber. Clean away any rubber or steel dust left behind both inside and outside the tire. Using a low speed buffer and an appropriate buffing wheel, round over the edges of the prepared area.

#### Preparing the Inside of the Tire

5. Clean the inner liner around the injury area with a pre-buff chemical rubber cleaner. Using an inner liner scraper, remove dirt, mold lubricants, and other contaminants.
6. Using a low speed buffer with an appropriate buffing wheel, buff an area about 1" larger than the injury area to an RMA #1 texture (see bottom of page 129). As on the other side, round over the edges of the prepared area. Use a vacuum cleaner to remove buffing dust.
7. Measure the thickness of the tire at the injury area and note this measurement for future reference. Also measure and record the dimensions of the repair area.
8. Spread a generous coating of Black Retreader's Cement over the prepared injury area both inside and outside the tire.

#### Filling the Injury

9. Secure a backing plate on the inner liner. Fill the injury area with an appropriate filling material. Stitch and pack material so as to avoid creating any gaps or air pockets, working from the center outward, making sure to stitch rubber over the edges. Filling material should be about 1/8" (3mm) above the outside of the tire when finished packing. Remove the backing plate and cure the filling material following manufacturer's cure time recommendations.

### REPAIR UNIT APPLICATION

10. Select the appropriate repair unit and center it over the injury on the inner liner. Mark an area about 1/2" (13mm) larger than the selected repair unit. Clean the selected area completely with a pre-buff rubber cleaner. Using an inner liner scraper, remove all dirt, mold lubricants, and other contaminants.
11. Using a low speed buffer and an appropriate buffing wheel, buff the selected area to an RMA #1 texture (see bottom of page 127). Remove all buffing dust with a vacuum.
12. Using a chemical vulcanizing cement recommended by the repair manufacturer, apply a thin, even coating to the prepared and buffed surface. Allow cement to dry thoroughly!
13. While beads are in a relaxed position, remove backing from repair unit and center the repair over the injury. Stitch repair down thoroughly with a stitching tool, working from the center out, removing all trapped air and making sure to stitch the edges.
14. Once the repair unit has been stitched down, apply a generous coating of Inner Liner Sealer to the edges of the repair unit.

### FINISHING THE REPAIR

15. Using a low speed buffer and an appropriate buffing wheel, lightly buff the outside of the repaired area until the rubber is flush with the surrounding area, presenting a smooth finished appearance.
16. For tread area repairs, use a regroover to replace original tread design. For sidewall repairs, apply a Section ID Patch on the outside of the tire next to the repaired area to indicate the location of the section repair.



**Accelerator** – A chemical which affects the rate of vulcanization of the rubber compounds.

**Air Injection** – An inspection method using a high pressure air probe to detect separation.

**Awl** – A pointed round tool used to probe nail holes and other injuries.

**Backing** – A removable protective material used on the application side of retread rubber and repair materials to preserve cleanliness and tackiness.

**Band Ply** – The inner cord ply of a tire.

**Bead** – That anchoring part of the tire which is shaped to fit the rim. Made of high tensile steel wires wrapped and reinforced by the plies.

**Bead Centering Plate** – An alignment device used to reduce tire diameter and center the casing in the retread matrix.

**Bead to Bead Measurement** – The distance from the heel of one bead straight up at 90° to the bead over the crown and down the other side to a position on the heel of the other bead directly opposite the starting point.

**Belt Edge Separation** – Separation adjacent to any edge of the tire.

**Break** – A crack extending into or through the fabric. An impact break is usually in the shape of an X or star and can be seen from the inside of the tire. A flex or circumferential break runs parallel to the beads.

**Breaker Strip** – A band or strip of rubber coated bias cut tire cord placed circumferentially around the tire between the last ply of casing fabric and tread. Sometimes called the impact or shock ply.

**Broken Belts or Plies** – A break limited to one or more belts or plies of the tire.

**Buckled Tread** – Tire distortion caused by improper molding, evidenced by wrinkling on the inside of the casing.

**Buff Contour** – The specified shape of a buffed tire.

**Buff Line** – The dividing line in the cross section of a tire between the buffed surface of the original tire and the new retread rubber.

**Buffed Surface** – The specially prepared surface of a tire casing to provide proper adhesion between the previously vulcanized casing and the new rubber.

**Buffer** – A machine used to rasp the old tread from the tire.

**Buffing Template** – A machined device of a specified shape used to obtain the required buffed contour.

**Builder** – A machine used to apply tread rubber to a casing.

**Build-Up** – The application of retread or repair rubber.

**Buzz-Outs** – (See Skiving)

**Casing** – The tire structure, excepting tread and sidewall rubber.

**Cement** – An adhesive rubber compound dissolved in solvent used to provide building tack and cured adhesion. May be brushed or sprayed on the buffed surface.

**Centerline** – An inked line or indentation applied during extrusion to the center of the tread rubber to aid in positioning the tread.

**Chafer Fabric** – The layer of fabric covering the bead in the area between the bead and rim.

**Channeling** – Voids in the shoulder area between the tread and buffed surface.

**Check Valve** – A one way valve used to prevent pressure loss.

**Chemical Cleaning** – A rapid drying rubber solvent for removing mold lubricant, dirt, and other foreign material before mechanical buffing.

**Chemical Cure** – Vulcanization at room temperature activated by chemical agents without the application of heat from an outside source.

**Chemical Leak Detector** – A liquid capable of detecting air seepage not discernible by visual inspection.

**Chemical Vulcanizing Cement (Chemical Cement)** – Cement which when used with compatible materials will produce a chemical cure.

**Chunking** – Separation of tread from the casing in particles that may range from a very small size to several square inches in area.

**Cords** – The strands forming the plies in a tire.

**Corrosion** – Degradation of steel reinforcing members.

**Cross Section** – The maximum width of the tire.

**Crown Width** – The distance shoulder to shoulder measured along the buffed contour.

**Cure Time** – The time required at a reference temperature for a compound to reach optimum physical properties.

**Curing Rim** – The rim used to support the tire and keep the curing tube in place while curing.

**Curing Tube** – Special, heavy duty tube placed within the tire while curing.

**Cushion Gum** – A tacky rubber compound used for adhesion, undertread repair, and build-up. (Also See Precured Tread Cushion Gum).

**Cut-off Rib** – An indentation molded into a retreaded tire to produce a sharp ending at the edge of the new retread rubber.

**Debagger** – A device for inserting and removing curing tubes.

**Delugger** – A machine used to cut the lugs from tires prior to buffing.

**Detreader** – A machine that delugs and buffs a used tire.

**Die Size** – A coded description of the dimensions of tread rubber.

**Extruder** – A machine that shapes a rubber compound, by the process of extruding, into a usable form (i.e. strip or die size).

**Fabric Fatigue** – Fabric degradation and resultant tire cord breakdown due to repeated flexing.

**Filler Strip** – A free flowing rubber used under the tread when added thickness is needed.

**Flow Stop** – An indentation molded into a retreaded tire to produce a sharp ending at the edge of the new retread rubber.

**Full Capping** – Application of new rubber to the tread area and some distance down the sidewall of a used tire. Gives the appearance of a new tire.

**Groove** – Space between two adjacent tread ribs.

**Groove Cracking** – Cracking which occurs at the bottom of a tread groove.

**Heat Booster** – An electric heating unit, which, when placed between the airbag and the casing of the tire, provides internal heat and aids in the curing of the tire.

**Kettle Cure** – Cure method employing steam and air for the heat and pressure required in vulcanizing.

**Liner** – The tubeless tire inner surface used to retain the inflation media.

**Lug Tearing** - Rupture of the lug, sometimes resulting in removal, resulting from violent operation or mechanical interference.

**Mandrel** – A curved support inserted in a tire to prevent the casing from collapsing while building a repair.

**Matrix** – Aluminum or steel rings or segments which form the cavity in which the tire is actually cured and from which the tread design is formed.

**Matrix Skirt** – The sidewall flange of the matrix. In a short skirt matrix the flange extends from the shoulder to the flow stop and in a long skirt matrix it extends below the flow stop.

**Moisture Blows** – Ply separations caused by the presence of moisture in the carcass which, when subjected to heat, becomes steam and expands.

**Mold** – Equipment in which the new tread is cured to the worn tire. Mold includes the steam chamber, matrix, and adjusting devices.

**Mold Lubricant** – Material used as a mold release to facilitate removal of the tire from the mold after curing.

**Non-Fill** – Failure of the tread rubber to properly fill the matrix during cure, resulting in imperfectly formed tread elements and rounded lug edges.

**Open Splice** – A retreaded tire defect caused by failure of the rubber to knit together properly at the tread splice during cure.

**Optimum Cure** – That state of cure at which the rubber compound exhibits the most satisfactory physical properties. Usually expressed in minutes curing time at a specified temperature.

**Orbitread Machine** – A combined tuber-builder that applies tread rubber in ribbon form, and in a spiral configuration.

**Overall Diameter (O.D.)** – A measurement used to size a buffed tire. Usually made on an inflated tire using calipers or a diameter type rule.

**Overcure** – Vulcanizing longer than necessary. Can result in the deterioration of certain physical properties.

**Overflow** – Spew-out of tread compound at the mold parting line or at the edge of the matrix skirt which should be trimmed or buffed off the finished product.

**Padding Gum** – Heat resistant rubber used under tread rubber to build up its size for mold fit.

**Peaking** – A condition, usually in the cushion, resulting from local material starvation and excessive flow from adjacent areas.

**Ply** – A layer of rubber coated parallel cords.

**Ply Separation** – A parting of rubber compound between adjacent plies.

**Potentiometer** – A millivoltmeter calibrated to sense temperature in a desired range. (Usually direct reading.)

**Precured Tread** – Tread which is vulcanized with the tread configuration molded into it prior to being placed on the buffed casing.

**Precured Tread Cushion Gum** – A tacky rubber compound used to bond the precured tread to the buffed surface.

**Press (Loading)** – A machine designed to open and close a matrix, load and eject retreaded tires.

**Press Plate** – Ring shaped plates in molds which may be adjusted to alter the cross section of tires.

**Pyrometer** – An instrument to measure temperatures – usually by the generation of electric current by a thermocouple when acted on by direct heat. Commonly used to measure surface mold temperatures or (if a penetrating needle is used) tread rubber temperatures.

**Rasp** – A tool with raised points forming the cutting prominences, used for roughening rubber surfaces.

Reprinted with permission of the Rubber Manufacturers Association (RMA)



**Radial Cracking** – Cracking, usually in or near the rib area, resulting from under-inflation (or ozone exposure).

**Reducing Valve** – Pressure regulating device used for controlling steam or air pressure at desired level.

**Regrooving (Recutting)** – The cutting of a tread design into tread rubber where a design does not already exist or the cutting into an existing tread design to a depth greater than that provided by the new tire manufacturer or retreader.

**Reinforcement** – Any material, usually rubber and fabric, vulcanized to the tire to add strength to the cord body at an injury.

**Reinforcement Repair** – Repairs made to the casing when an injury has extended through more than 25% but less than 75% of the tire body requiring both hole-filling material and reinforcing patches.

**Relugging** – A method of retreading big type design tires using hand build-up and kettle cure.

**Repair Gum** – Material used for filling voids, or covering reinforcing material in a tire repair.

**Repaired Tire** – Any tire with punctures, cuts or other types of injuries that have been reconditioned as required to provide additional safe service life.

**Repair Patch** – The reinforcing material used to seal and/or reinforce the injury in a tire.

**Repair Plug** – The material that fills the cavity of an injury in a tire.

**Retread Tire** – A casing to which tread rubber has been affixed to extend the usable life of the tire.

**Reversion** – Excessive heating of a cured rubber compound leading to deterioration of its physical properties.

**Rim** – A metal support for a tire or a tire and tube assembly upon which the tire beads are seated.

**Rim Diameter** – The diameter (conventionalized) of the rim corresponding to the tire bead heel.

**Rim Flange** – That part of the rim that supports the bead heel and resists lateral internal pressure.

**Rust** – Advanced stage of corrosion (See Corrosion).

**Scorching of Rubber** – Excessive heat of processing equipment which detrimentally changes the surface of the rubber.

**Section Repair** – Repairs, other than nail hole type, made to the casing when an injury has extended through 75% or more of the actual plies, or completely through the casing in the tread or sidewall areas.

**Sectional Bag (Air-Steam)** – A rubberized fabric bag made in 1/4, 1/5, or 1/6 circle with valves at both ends. When inflated inside a tire in a sectional mold, it applies pressure in the vicinity of the injury.

**Self Vulcanization** – (See Chemical Cure).

**Separation** – A loosened area within the tire.

**Set-up** – Premature vulcanization of a rubber compound during processing or storage.

**Shaping** – Buffing the casing to shape it to properly fit the size and contour of the matrix cavity.

**Shelf-Life** – Refers to the accepted length of time that a perishable product may remain in stock before serious deterioration takes place.

**Shoulder Radius** – Small radius, (generally) that joins the primary tread radius to the shoulder contour.

**Sidewall** – That portion of a tire between the tread and bead.

**Sipe** – Any of the small often hooked shaped or bracket shaped grooves in the tread of an automobile tire for providing extra traction and preventing skids.

**Size Factor** – The size factor of a tire is the sum of its section width on its measuring rim and its outer diameter.

**Sizing** – Measuring the tire casing to determine proper matrix fit. Usually a combination of bead to bead or cross section and tire circumference is used.

**Skid Depth (Tread Depth)** – The distance measured near the centerline of the tire, from the base of the tread design to the top of the tread.

**Skiving** – The removal of damaged material prior to making a repair.

**Slab Stock** – Tread compound cut from a rubber mill in wide, thick strips.

**Spacer Ring** – A ring inserted between two halves of a matrix which enables the matrix to handle tires of the same diameter, but with greater tread widths and larger cross sections.

**Special Mileage Tire** – A tire manufactured with an extra layer of rubber between the cord body and the original tread design, which extra layer is designed for the purpose of recutting and regrooving, and which is specifically labeled as a special mileage commercial tire.

**Splice-Butt** – A 90° angle cut across the tread crown and through the gauge which permits full matching of the tread ends when they meet.

**Splice-Bevel** – A continuous and approximate 45° angle cut through the gauge which allows the tread ends to diagonally overlap themselves.



**Spot Repair** – The replacement of rubber in an injury that penetrates less than 25% of the body plies.

**Spotter** – A heat vulcanizing unit used in spot repairs, with a metal curing plate for either (or both) outside or inside tire surface.

**Spreader** – A multi-arm device that spreads a tire at the bead area.

**Standard Rim** – A rim that has been calibrated and found to meet the precise measurements specified by the Tire and Rim Association, Inc. or, where applicable, by European Tire and Rim Association.

**Steam Trap** – A drainable end of the steam supply line low pressure trap which helps avoid low pressure areas in the steam piping.

**Stitching** – A hard rolling method used to both remove trapped air and improve rubber contact for better adhesion.

**Stop Ring** – An indentation molded into a retreaded tire to produce a sharp ending at the edge of the new retread rubber.

**Strip Rubber** – Tread rubber in strip form most commonly used in cold feed extruders.

**Stripping Stock** – A rubber stock used to extend the wing of tread rubber.

**Tack** – A term used to describe tackiness.

**Template (Buffing Template)** – A pre-cut pattern, usually metal, used to determine the contour of a buffed tire in order for the tire to be compatible with the matrix.

**Thermocouple Test** – A heat study which utilizes special temperature wires and determines temperatures received at both the surface and base of the retread.

**Tire Paint** – A black paint, compatible to tire bodies, used to enhance the appearance of a tire.

**Toe** – The part of the bead which faces the inside portion of the tire.

**Top Cap (Top Treading)** – A retread which covers the crown, or top, of a tire.

**Tread** – That portion of a tire that comes in contact with the road.

**Tread Depth** – The distance, measured near the centerline of the tire, from the base of the tread design to the top of the tread.

**Tread Design** – The non-skid pattern (design) on the tread portion of the tire.

**Tread Rib** – A tread section running circumferentially around a tire.

**Tread Gum** – A rubber compound, used primarily to build up the tread when making a repair.

**Tread Radius** – A measure of tread surface curvature from shoulder to shoulder.

**Tread Roller** – A roller, either manual or power, used to help apply the tread rubber, remove trapped air and obtain adhesion.

**Tread Rubber** – Uncured rubber material which will replace the worn off tread portion of a tire.

**Tread Separation** – Pulling away of the tread from the tire casing.

**Tread Tearing** – A tearing away of a portion of the tread design due usually to an in-shop condition.

**Tube Plate** – A heated metal plate with a smooth surface and is used in making repairs.

**Tulip Type Segmented Mold** – Shoulder to shoulder segments which come together on a single cone.

**Undercure** – A condition which describes less than acceptable vulcanization, or curing.

**Undertread** – The rubber between the base of the tread and the tire body.

**Valley Die** – A tube die size configuration, which from a cross view, shows that either shoulder is higher than the center portion.

**Vent Hole** – Small circular holes in the tread area of the matrix which allows the rubber to flow and fill out the tread design.

**Venting** – The act of perforating a tire above the beads which allows the internal pressure in the cords to escape safely and without loss of tire air retention ability.

**Voids** – A situation whereby the tread rubber flow fills the tread design but does not completely fill the space between the tire casing and matrix, thereby leaving portions of the base in an unfilled condition.

**Vulcanization** – A chemical condition which takes place under appropriate curing time, temperature and pressure and develops usable (tire) characteristics.

**Vulcanizing Cement** – A cement containing additives to provide building tackiness and to cure under heat.

**Weather Checking** – A visual sidewall condition which appears as cracking of the rubber.

**Wicking** – A capillary act of air escapement from the tire casing through the use of a piece of cord.

**WSW Protective Paint** – A special and washable paint, usually colored, used to protect the white sidewall from excess dirt, stains or blemishes while the tire is in inventory.

## GLOSSARY OF TPMS TERMS

**ABS** – Anti-lock braking system.

**Activation Tool** – Electronic tool used to activate, trigger or wake-up a TPMS sensor once it has entered the Sleep Mode. Typically, the tool sends a 125kHz LF signal to the TPMS sensor forcing it to wake-up and transmit data. Activation tools may be needed to aid in the relearn processes.

**Banded Sensor** – Sensor mounted in the drop center of the wheel using a metal band. The sensor is typically mounted 180° from the valve stem. The sensor is attached to the metal band using a cradle and secured to the cradle with a plastic clip. Ford is the only vehicle manufacturer that uses banded sensors, as original equipment, on their vehicles.

**Clamp-in Style Sensor** – Sensor mounted to the wheel through the rim hole using a special sealing nut to secure it into the wheel. These sensors can usually be identified by their aluminum valve stem.

**Cradle** – The carrier that holds the banded sensor to the band.

**Continuous Wave Sensors** – Sensors designed to trigger when they are exposed to a continuous electronic signal for 4-7 seconds.

**Copy (Clone)** – Process of duplicating a sensor whereby a vehicle relearn may be avoided.

**Decimal** – Sensor ID format consisting of all numeric (numbers) characters.

**Direct TPMS** – System that uses wheel mounted sensors or transmitters to transmit information to the vehicles ECU. This system meets current federal regulations.

**Drive Mode** – When a vehicle reaches a certain velocity, for a specified period, the sensor enters drive mode and transmits data at regular intervals.

**Driver Information Center (DIC)** - Appears on display to show driver the individual pressure of each tire.

**Electronic Control Unit (ECU)** – Device that decodes the TPMS data and converts the data into information that can be used by the vehicle systems.

**FCC** – Federal Communications Commission

**FMVSS 138** – The Federal Motor Vehicle Safety Standard adopted by the NHTSA, as required by legislation known as the TREAD Act, mandating that TPMS be installed on all new vehicles having a GVWR of 10,000 lbs. or less except motorcycles and those vehicles with dual wheels on an axle.

**Galvanic Corrosion** – Corrosion caused by two dissimilar metals in contact with each other.

**Gross Vehicle Weight (GVW)** – The total weight of a loaded vehicle including the chassis, body and payload.

**Hexadecimal** – Sensor ID format that may consist of all numeric (numbers) characters or a combination of numeric and alpha (A, B, C, D, E, F) characters.

**Hi-Line** – Vehicle displays “Pressure by Location” (each individual tire pressure).

**ID** – Identification

**Indirect TPMS** – System based on the use of a vehicle's ABS. This type of system does not require the use of sensors or transmitters. Indirect systems were once popular, but those systems did not meet current federal regulations.

**Learn Mode** – Mode in which the vehicle's receiver stores the sensor's ID, within its memory, for future identification purposes.

**LF** – Low Frequency (Trigger Frequency) 125kHz

**Low-Line** – Vehicle displays on the MIL (Malfunction Indicator Lamp)

**Magnetically Triggered Sensors** – Sensor designed to trigger when exposed to a powerful magnetic wave

**Malfunction Indicator Lamp (MIL)** - Light that appears on the dash to warn that the TPMS is not operational.

**NHTSA** – National Highway Traffic Safety Administration. The U.S. federal agency that develops and administers educational, engineering and enforcement programs for safe vehicle use and cost-effective highway travel.

**Normal Mode** – Also referred to as Park Mode, is the state the TPMS sensor is in during normal driving operations.

**OBDII** – On-Board Diagnostic systems were introduced as an electronic means to control engine functions and diagnose engine problems. OBDII, introduced in the mid-90's, provides almost complete engine control and also monitors parts of the chassis, body and accessory devices, as well as the diagnostic control network of the car.

**OEM** – Original Equipment Manufacturer.

**Off Mode** – Also referred to as Ship Mode is the TPMS sensor state where no transmission occurs and pressure sampling occurs once every 30 seconds. Mainly used for shipment and storage, sensors will remain in this condition until activated into another mode. Sensors being shipped from overseas are often shipped in Off Mode because the FCC will not allow any electronic devices to transmit any type of signal that may interfere with radio air waves. It is important to note that not all sensors are shipped in this mode.

**Park Mode** – Also referred to as Normal Mode, is the state the TPMS sensor is in during normal driving operations.

**Pulse Modulated Sensors** – Sensors designed to trigger when they are exposed to a 125kHz signal with a specific and exclusive OEM electronic pattern.

**Pressure by Location** – Vehicle will display each tire's pressure on the dash.

**Protocol** – The specific internal programming that runs the TPMS sensor.

**Receiver** – Device that decodes the TPMS sensor data and converts it into information used by the vehicles onboard computer system.

**Relearn** – Many TPMS systems require retraining each time the tires/wheel are rotated or a sensor is replaced. Retraining is necessary for the system to learn the sensor(s) new position(s). A relearn procedure may need to be followed in order to retrain the system. Relearn procedures differ by vehicle makes and are sometimes found in the vehicles Owner's Manual. In those instances where the relearn procedure is not found in the Owner's Manual a TPMS service guide may need to be referenced to find the relearn procedure.

**Auto-Relearn** – Sensors are learned automatically, to the vehicle's ECU, usually by driving the vehicle at a specified speed continuously for a specified amount of time.

**Stationary Relearn** – Sensors are relearned to the vehicle via an RF signal (typically by a TPMS tool) that is sent from each sensor after the vehicle has been put into learn mode.

**OBD Relearn** – Sensors are read by an OBD capable TPMS tool and then relearned to the vehicle by connecting directly to the ECU via the OBD connector.

**RF** – Radio Frequency (Transmitted Frequency)

**Sensor ID** – The identification number assigned to a TPMS sensor that is unique to that sensor only. The ID is stored in the vehicle's ECU.

**Service Kit** – Kit of components needed to properly service TPMS sensors. This kit can include replacement valves, cores, caps, grommets, locking nuts, and washers. The OEM recommends replacing the EPDM grommet, valve cap, valve core and locking nut every time a TPMS sensor is removed from the wheel or the wheel is serviced.

**Ship Mode** – Also referred to as **Off Mode** is the TPMS sensor state where no transmission occurs and pressure sampling occurs once every 30 seconds. Mainly used for shipment and storage, sensors will remain in this condition until activated into another mode. Sensors being shipped from overseas are often shipped in **Off Mode** because the FCC will not allow any electronic devices to transmit any type of signal that may interfere with radio air waves. It is important to note that not all sensors are shipped in this mode.

**Sleep Mode** – TPMS sensor state that occurs in between the time the sensor transmits and measures data.

**Snap-In Style Sensor** – Sensor mounted to the wheel through the rim hole using a special rubber snap-in valve that is attached to the sensor module using a special T-10 TORX head screw. To identify a Snap-in TPMS sensor, look for a long valve cap or an extended brass shoulder.

**Test Mode** – Sometimes referred to as **Factory Test Mode**, is the state in which the sensor transmits at the most frequent transmission rate possible. This mode is used by vehicle assembly plant tests.

**TPM** – Tire Pressure Monitoring.

**TPMS Sensor** – Also referred to as sensors, are wheel based electronic sensors used to transmit information/data in TPMS systems.

**TPMS** – Tire Pressure Monitoring System. A warning system that notifies the driver when a tire is significantly under-inflated.

**TPMS Grommet** – Many stem mounted sensors use a special rubber grommet for sealing. The OEM recommends replacing the grommet whenever the sensor is removed from the wheel. The rubber grommet provides the air seal in the valve stem opening, and a new one should be used to ensure a fresh seal after each service.

**TPMS Nut** – Many TPMS sensors are attached to the wheel using a specially designed sealing nut. The OEM recommends replacing these nuts whenever it is removed. These nuts are either 11mm or 12mm. Each manufacture has its own recommended torque specification for the TPMS nuts.

**TPMS Valve Cap** – TPMS sensors with an aluminum valve stem require a specially designed sealing cap. Sensors with an aluminum stem cannot use a standard (non-TPMS) valve cap. These special valve caps are designed for use with TPMS sensors and protect against the corrosion that forms when dissimilar metals come in contact.

**TPMS Valve Core** – Many TPMS sensors have an aluminum valve stem with a specially designed valve core. The OEM recommends replacing this valve core whenever it is removed. Sensors with an aluminum valve stem cannot use a standard brass valve core; instead, they require a special nickel-plated valve core to protect against the corrosion that forms when dissimilar metals come in contact. The Tire and Rim Association (TRA) recommends a torque specification of 2 – 5 inch pounds for TR C1 valve cores. Sensors with a rubber valve stem may use a standard brass valve core for replacement.

**TRA** – Tire and Rim Association. The standardizing body for the tire, rim, valve and allied parts industry for the United States.

**TREAD Act** – Transportation Recall Enforcement Accountability Documentation Act. The law that mandates, beginning September 1, 2007, all new vehicles sold in the U.S. under a GVW of 10,000 lbs., excluding motorcycles and light duty trucks with dual wheels on an axle, are required to be equipped with a tire pressure monitoring system (TPMS) to warn drivers when one or more of a vehicles tires are under-inflated by 25% or more.

**TSS** – Tire Safety System

**UHF** – Ultra High Frequency 315MHz and 433.92 (sometimes referred to as 434) MHz.

## TPMS SERVICE PROCEDURE

### INITIAL INSPECTION

- A.** Before performing wheel service on any vehicle, check to see if the wheels are equipped with TPMS sensors.
- B.** Following the diagnostic tool manufacturer's instructions, check each sensor to ensure each is working properly and note the state of each on the service ticket.
- C.** If a sensor is not working properly, inform the vehicle owner that it will need to be replaced.

### SENSOR IDENTIFICATION

- D.** Identify which type TPMS sensor is on the vehicle as seen below. Then follow the steps to the right for that type of sensor.  
Complete service by following Step F.

#### CLAMP-IN SENSORS

have an aluminum valve stem mounted directly to the wheel through the valve hole using a special aluminum nut.



#### SNAP-IN SENSORS

have a rubber snap-in valve stem mounted directly to the wheel through the valve hole. Typically identified by the long, black plastic cap and/or the extended brass shoulder.



#### BANDED SENSORS

mounted in the center of the wheel using a metal band typically 180° from the valve stem. Ford is the only vehicle manufacturer using banded sensors as original equipment.



### E. SERVICING –

#### CLAMP-IN SENSORS

1. Remove the tire from the vehicle following industry recommended procedures.
2. Deflate the tire by removing the valve core using a valve core removal tool and releasing the air completely.
3. Remove the sensor nut and push the sensor inside the tire.
4. Break the tire beads at 90° and 270° from the valve stem and remove the sensor from the wheel.
5. Dispose of the valve cap, core, nut and rubber grommet.
6. Using the appropriate new service kit, replace the valve core and grommet.
7. Reinstall the sensor through the rim hole with the flat side of the sensor facing the rim.
8. Install the new nut using a torque wrench and tighten to the proper torque specification.
9. Install the new sealing valve cap.
10. Service the tire/wheel as required following all industry and tire manufacturer guidelines.
11. Mount the tire onto the wheel taking special care not to damage the TPMS sensor.
12. Inflate the tire to the recommended placard pressure.

#### SNAP-IN SENSORS

1. Remove the tire from the vehicle following industry recommended procedures.
2. Deflate the tire by removing the valve core using a valve core removal tool and releasing the air completely.
3. Break the tire beads at 90° and 270° from the valve stem and remove the sensor from the wheel.
4. Remove the screw from the base of the sensor using a T-10 torque screwdriver tool and carefully remove the sensor from the valve stem.
5. Dispose of the old screw.
6. Remove the rubber snap-in valve from the wheel as normal.
7. Attach the sensor to the rubber snap-in valve using a new T-10 TORX screw, then torque the screw to 11.5 in-lbs (1.3 N.m.)
8. Apply mounting lube to the rubber snap-in valve stem.
9. Align the sensor with the rim hole and attach a standard valve installation tool.
10. Pull the valve stem straight into the valve hole until it is properly seated.
11. Service the tire / wheel as required following all industry and tire manufacturer guidelines.
12. Mount the tire onto the wheel taking special care not to damage the TPMS sensor.
13. Inflate the tire to the recommended placard pressure and install the new sealing valve cap.

#### BANDED SENSORS

1. Remove the tire from the vehicle following industry recommended procedures.
2. Deflate the tire by removing the valve core using a valve core removal tool and releasing the air completely.
3. Break the tire beads at 90° and 270° from the valve stem and remove the sensor from the wheel.
4. Remove the mounting clip to release the sensor from the mounting bracket.
5. Gently pry the sensor from the open end of the bracket and discard the mounting clip.
6. If the mounting band and/or mounting bracket show signs of wear or corrosion, replace with a new band and/or mounting bracket.
7. Install a new sensor using a new retaining clip.
8. Service the tire/wheel as required following all industry and tire manufacturer guidelines.
9. Mount the tire onto the wheel taking special care not to damage the TPMS sensor.
10. Inflate the tire to the recommended placard pressure.

### F. SERVICE COMPLETION

1. Using your TPMS sensor activation tool, check all sensors making sure each is working properly.
2. Refer to your Motor TPMS Guide or vehicle owner's manual to determine if a TPMS relearn is necessary. A TPMS relearn tool may be required to reset the system.
3. If necessary, follow the instructions for resetting the vehicles TPMS system.



## 14-603 WALL CABINET PUNCTURE REPAIR SYSTEM

1	14-600	Wall Cabinet
1		RMA Wallchart
1		X-tra Seal Catalog
<b>TIRE REPAIR MATERIALS AND CHEMICALS</b>		
1	11-002	2-1/4" Tube Patch
1	11-321	1-3/4" Round Uni
1	11-322	2-1/4" Round Uni
1	13-621	3/16" Injury Lead Wire Stem
1	13-620	1/4" Injury Lead Wire Stem
1	13-672	3/16" Injury Lead Wire Combination Repair
2	13-673	1/4" Injury Lead Wire Combination Repair
1	14-008	Vulcanizing Cement
1	14-100	Rubber Prep
1	14-101	Bead Sealer
1	14-128A	Inner liner Sealer
<b>TOOLS</b>		
1	14-399-1	Spiff Vacuum (vacuum only)
1	14-921	XLIGHT
1	14-802	Safety Glasses
1	14-319DX	Deluxe Low Speed Buffer Kit
1	14-345	3/16" Injury Carbide Cutter
1	14-346	1/4" Injury Carbide Cutter
1	14-333	QC Adapter for 345 Carbide
1	14-334	QC Adapter for 346 Carbide
1	14-330	QC Adapter for BS-1
1	14-320	BS-1 Buffing Wheel
1	14-314	Patch Stitcher
1	14-315H	Inner Liner Scraper
1	14-553	White Paint Stick
1	14-301	Brass Brush
1	14-310	Power Awl
1	14-218	Spiral Cement Tool
1	14-318R	Inline Air Regulator

## 14-605 TRUCK TIRE PUNCTURE CABINET REPAIR SYSTEM

1	14-600	Wall Cabinet
1		X-tra Seal Cabinet Decal
1		X-tra Seal Catalog
1		Puncture Repair Procedure Guide
1		RMA Truck Puncture Wall Chart
<b>TIRE REPAIR MATERIALS AND CHEMICALS</b>		
1	11-311	2-1/4" Square Euro-style Universal Patch
1	11-712	Radial 12 - Reinforced Patch
1	13-620	1/4" Injury Lead-Wire Stem
1	13-623	3/8" Injury Lead-Wire Stem
2	13-673	1/4" Injury Combination Repair
2	13-675	3/8" Injury Combination Repair
2	14-008	Vulcanizing Cement
2	14-100	Rubber Prep
1	14-128A	Inner Liner Sealer
<b>TOOLS</b>		
1	14-802	Safety Glasses
1	14-204	Spiral Cement Tool
1	14-301	Brass Brush
1	14-305	Flex Skiving Knife
1	14-314	Patch Stitcher
1	14-315H	Inner Liner Scraper
1	14-359	2" Dome 60 Grit Buffing Wheel
1	14-319DX	Deluxe Low Speed Buffer Kit
1	14-326K	Low Speed Reversible Drill
1	14-331	Long QC Adapter for Buffing Wheel
1	14-346	1/4" Injury Carbide Cutter
1	14-348	3/8" Injury Carbide Cutter
1	14-399	Spiff Vacuum
1	14-554	Markal Paint Stick
1	14-803	Work Gloves

## 14-604 WALL CABINET PUNCTURE REPAIR SYSTEM

1	14-600	Wall Cabinet
1		X-tra Seal Cabinet Decal
1		X-tra Seal Catalog
1		Puncture Repair Procedure Guide
1		RMA Wall Chart
<b>TIRE REPAIR MATERIALS AND CHEMICALS</b>		
1	11-311	2-1/4" Square Euro-style Universal Patch
1	13-621	3/16" Injury Lead Wire Insert
1	13-620	1/4" Injury Lead Wire Insert
2	13-672	3/16" Injury Combination Repair
2	13-673	1/4" Injury Combination Repair
2	14-008	Vulcanizing Cement
2	14-100	Rubber Prep
1	14-128A	Inner Liner Sealer
1	14-101	Bead Sealer
<b>TOOLS</b>		
1	14-204	Spiral Cement Tool
1	14-301	Brass Brush
1	14-305	Flex Skiving Knife
1	14-314	Patch Stitcher
1	14-315H	Inner Liner Scraper
1	14-319DX	Deluxe Low-Speed Buffer kit
1	14-359	2" Dome Buffing Wheel
1	14-326K	Deluxe Low-Speed Reversible Drill
1	14-331	Long QC Adapter for BS-1
1	14-333	QC Adapter for 345 Carbide
1	14-345	Carbide Cutter - 3/16" Injury
1	14-334	QC Adapter for 346 carbide
1	14-346	Carbide Cutter - 1/4" Injury
1	14-399	Spiff Vacuum
1	14-554	Markal Paint Stick
1	14-803	Work Gloves
1	14-802	Safety Glasses
1	14-921	XLIGHT

## 14-613 SERVICE CART PUNCTURE REPAIR SYSTEM

1	14-614	HD Service Cart
1		X-tra Seal Decal
1		X-tra Seal Catalog
1		Puncture Repair Procedure Guide
1		RMA Wall Chart
<b>TIRE REPAIR MATERIALS AND CHEMICALS</b>		
1	11-309	2" Square Universal Patch
1	13-621	3/16" Injury Lead Wire Insert
1	13-620	1/4" Injury Lead Wire Insert
1	13-672	3/16" Injury Combination Repair
2	13-673	1/4" Injury Combination Repair
1	14-008	Vulcanizing Cement
1	14-100	Rubber Prep
1	14-128A	Inner Liner Sealer
1	14-101	Bead Sealer
<b>TOOLS</b>		
1	14-204	Spiral Cement Probe
1	14-301	Brass Brush
1	14-305	Flex Skiving Knife
1	14-314	Patch Stitcher
1	14-315H	Inner Liner Scraper
1	14-319DX	Deluxe Low Speed Buffer Kit
1	14-318R	Inline Air Regulator
1	14-359	2" Dome Buffing Wheel
1	14-330	QC Adapter - Buffing Wheel
1	14-333	QC Adapter - 345 Carbide
1	14-334	QC Adapter - 346 Carbide
1	14-345	3/16" Injury - Carbide Cutter
1	14-346	1/4" Injury - Carbide Cutter
1 PC	14-553	White Paint Stick
1	14-802	Safety Glasses
1	14-803	Work Gloves
1	14-399-1	Spiff Vacuum (vacuum only)



**14-650 TRUCK TIRE PUNCTURE TOOLBOX REPAIR SYSTEM**

- 1 14-652BOX Toolbox
- 1 X-tra Seal Catalog
- 1 RMA Truck Puncture Wall Chart
- 1 Puncture Repair Procedure Guide
- TIRE REPAIR MATERIALS AND CHEMICALS**
- 20 11-311 2-1/4" Square Euro-Style Universal Patch
- 1 11-491 4 1/4" Bias Ply Patches
- 1 11-655 Medum Round Euro Tube Repair
- 1 11-712 Radial 12 - Reinforced Patch
- 6 13-674 5/16" Lead-Wire Combination Unit
- 1 13-622 5/16" Lead-Wire Insert
- 2 14-511 HD Blue Vulcanizing Cement
- 1 14-100 Rubber Prep
- 1 14-128A Inner Liner Sealer
- TOOLS**
- 1 14-802 Safety Glasses
- 1 14-204 Spiral Cement Tool
- 1 14-305 Flex Skiving Knife
- 1 14-314 Patch Stitcher
- 1 14-315 Inner Liner Scraper
- 1 14-319LST Low-Speed Buffer Kit
- 2 14-553 White Paint Stick
- 1 14-803 Work Gloves
- 1 14-324 Arbor Adapter
- 1 14-347 5/16" Carbide Cutter
- 1 14-365 2 1/2" Carbide Buffing Wheel

**14-651 QUILLED UNIT PUNCTURE TOOLBOX REPAIR SYSTEM**

- 1 14-652BOX Toolbox
- 1 X-tra Seal Catalog
- 1 RMA Wall Chart
- 1 14-803 Mechanics Gloves
- 1 Puncture Repair Procedure Guide
- 1 Quilled Unit Wall Poster
- TIRE REPAIR MATERIALS AND CHEMICALS**
- 2 13-382 Large Quilled Combination Repair
- 2 13-381 Small Quilled Combination Repair
- 1 14-008 Vulcanizing Cement
- 1 14-100 Rubber Prep
- 1 14-128A Inner Liner Sealer
- 1 14-101 Bead Sealer
- TOOLS**
- 1 14-802 Safety Glasses
- 1 14-399-1 Spiff Vacuum (vacuum only)
- 1 14-319DX Deluxe Low Speed Buffer Kit
- 1 14-318R In-Line Air Regulator
- 1 14-330 QC Adapter
- 1 14-320 BS-1 Buffing Wheel
- 1 14-314 Patch Stitcher
- 1 14-315H Inner Liner Scraper
- 1 14-553 White Paint Stick
- 1 14-301 Brass Brush
- 1 14-310 Power Awl
- 1 14-218 Spiral Cement Tool
- 1 14-303S Stickle Back Probe, Small
- 1 14-303P Stickle Back Probe, Large

**14-652 TIRE REPAIR MATERIALS TOOLBOX SYSTEM**

- 1 14-652BOX Toolbox
- 1 X-tra Seal Catalog
- 1 RMA Wall Chart
- 1 Puncture Repair Procedure Guide
- TIRE REPAIR MATERIALS AND CHEMICALS**
- 1 11-322 2-1/4" Round Universal Patch
- 1 13-621 3/16" Injury Lead Wire Stem
- 1 13-620 1/4" Injury Lead Wire Stem
- 1 13-672 3/16" Injury Combination Repair
- 1 13-673 1/4" Injury Combination Repair
- 1 14-008 Vulcanizing Cement
- 1 14-100 Rubber Prep
- 1 14-128A Inner Liner Sealer
- 1 14-101 Bead Sealer
- 1 14-803 Mechanics Gloves

**14-653 PUNCTURE REPAIR TOOLBOX SYSTEM**

- 1 14-652BOX Toolbox
- 1 X-tra Seal Catalog
- 1 RMA Wall Chart
- 1 Puncture Repair Procedure Guide
- TIRE REPAIR MATERIALS AND CHEMICALS**
- 1 11-311 2-1/4" Square Uni-Euro Patch
- 1 13-621 3/16" Injury Lead Wire Stem
- 1 13-620 1/4" Injury Lead Wire Stem
- 1 13-672 3/16" Injury Combination Repair
- 2 13-673 1/4" Injury Combination Repair
- 1 14-008 Vulcanizing Cement
- 1 14-100 Rubber Prep
- 1 14-128A Inner Liner Sealer
- 1 14-101 Bead Sealer
- TOOLS**
- 1 14-802 Safety Glasses
- 1 14-399-1 Spiff Vacuum (vacuum only)
- 1 14-921 XLIGHT
- 1 14-319DX Deluxe Low Speed Buffer Kit
- 1 14-318R In-Line Air Regulator
- 1 14-345 3/16" Injury Carbide Cutter
- 1 14-346 1/4" Injury Carbide Cutter
- 1 14-333 QC Adapter for 345 Carbide
- 1 14-334 QC Adapter for 346 Carbide
- 1 14-330 QC Adapter
- 1 14-359 60 Grit 2" Dome Buffing Wheel
- 1 14-314 Patch Stitcher
- 1 14-315H Inner Liner Scraper
- 1 14-553 White Paint Stick
- 1 14-301 Brass Brush
- 1 14-310 Power Awl
- 1 14-218 Spiral Cement Tool
- 1 14-803 Mechanics Gloves

## 14-657 TRUCKTIRE PUNCTURE REPAIR SYSTEM

- 1 14-652BOX Toolbox
- 1 X-tra Seal Catalog
- 1 RMA Truck Puncture Wall Chart
- 1 Puncture Repair Procedure Guide

### TIRE REPAIR MATERIALS AND CHEMICALS

- 1 11-311 2-1/4" Square Euro-Style Universal Patch
- 1 11-712 Radial 12, Reinforced Patch
- 1 13-620 1/4" Injury Lead-Wire Stem
- 1 13-623 3/8" Injury Lead-Wire Stem
- 2 13-673 1/4" Injury Combination Repair
- 1 13-675 3/8" Injury Combination Repair
- 1 14-008 Vulcanizing Cement
- 1 14-100 Rubber Prep
- 1 14-128A Inner Liner Sealer

### TOOLS

- 1 14-802 Safety Glasses
- 1 14-204 Spiral Cement Tool
- 1 14-301 Brass Brush
- 1 14-305 Flex Skiving Knife
- 1 14-314 Patch Stitcher
- 1 14-315H Inner Liner Scraper
- 1 14-359 2" Dome 60 Grit Buffing Wheel
- 1 14-319DX Deluxe Low-Speed Buffer Kit
- 1 14-326K Low-Speed Reversible Drill
- 1 14-331 Long QC Adapter for Buffing Wheel
- 1 14-346 1/4" Injury Carbide Cutter
- 1 14-348 3/8" Injury Carbide Cutter
- 1 14-399 Spiff Vacuum
- 1 14-554 Markal Paint Stick
- 1 14-803 Work Gloves



# FLOOR SPINNER CONTENTS



*Let our experienced experts  
design the spinner that's right for you!*

## 15-9825 FLOOR SPINNER DISPLAY

*This is an example of a parts listing for a spinner*



- 3 14-008 Rubber Cement 8 oz., Flammable
- 1 14-100 32 oz. (945ml) Buffing Solution, Flammable
- 1 14-101 32 oz. (945ml) Bead Sealer, Flammable
- 2 11-321 1 3/4" (45mm) Small Round
- 2 11-322 2 1/4" (57mm) Medium Round
- 1 11-323 3 1/8" (79mm) Large Round
- 2 12-361 4" (102mm) Fat, Brown String
- 1 12-362 8" (204mm) Fat, Brown String

### DIY TIRE REPAIR

- 3 15-005 Tubeless Tire Repair Kit
- 3 15-011 Tubeless Tire Repair Kit
- 4 15-019 Radial Tire Patch Kit
- 4 15-020 Chemical Tire and Tube Patch Kit
- 4 15-026 1 oz. Rubber Cement, Flammable
- 2 15-390 4" Refill – 30 Pack
- 6 15-394 4" Refill – 5 Pack

### TIRE GAUGES

- 2 15-9061 Dial Gauge with Bleeder
- 4 15-908 Tractor Tire Gauge
- 4 15-909 Low-Pressure Tire Gauge
- 6 15-910 Deluxe Tire Gauge
- 4 15-911 High-Pressure Gauge
- 2 15-951 Mini Dial with Bleeder 0-60 psi
- 2 15-952 Low-Pressure Mini Dial 1-20 psi
- 4 15-1023 Mini Digital Tire Gauge
- 4 15-1021 Digital Tire Gauge
- 2 15-1027 Digital Truck Tire Gauge
- 2 15-1075 SUV Dial Gauge
- 4 15-1031 Pocket Dual-Foot Gauge
- 3 15-1045 Truck Gauge Straight-On
- 2 15-1078 High-Pressure Dial Gauge
- 3 15-1313 Truck Gauge

### VALVE HARDWARE

- 4 15-3607 Tread Depth Gauge
- 4 15-20008 Rubber Snap-in TPMS Valve for GM
- 4 15-412 1" Tire Valves
- 4 15-413 1 1/4" Tire Valves
- 2 15-4134 1 1/4" Tire Valves with Chrome Sleeve
- 4 15-4142 1 1/2" Tire Valves
- 4 15-4152 1 1/2" Tire Valves for 0.625" Rim Hole
- 4 15-418 2" Tire Valves
- 2 15-4184 2" Tire Valves with Chrome Sleeves
- 2 15-4252 2" Tire Valves for 0.625" Rim Hole
- 4 15-4559-2 1" Chrome Valve
- 4 15-4600 1 1/4" High Pressure Valves (TR600HP)
- 4 15-4904 TPMS Valve Cores, Red
- 4 15-4911 Slot Head Valve Caps
- 6 15-4922 Black Cap with Grommet
- 4 15-4923 Green Cap with Grommet
- 4 15-4932 Chrome Cap with Grommet
- 4 15-4933 Chrome Cap & Sleeves with Grommet
- 4 15-4927 Black Cap with Grommet for 15-20008
- 4 15-4925 Gray TPMS Cap with Grommet
- 4 15-604 4-Way Valve Tool

### AIR ACCESSORIES

- 4 15-501 Ball Foot Air Chuck
- 2 15-503 Ball Foot Air Chuck with Clip
- 4 15-5754 1/4" Hose Mender
- 4 15-5766 3/8" Hose Mender
- 4 15-5767 1/2" Hose Mender
- 4 15-5733 1/4" Barb 1/4" FNPT
- 4 15-5743 3/8" Barb 1/4" FNPT
- 4 15-5745 1/2" Barb 1/4" MNPT
- 4 15-7150BR Industrial Style, Type D, Coupler Female
- 4 15-7150 Industrial Style, Type D, Coupler Female
- 4 15-7122 Industrial Style, Type D, Plug Male
- 4 15-7132 Industrial Style, Type D, Plug Female
- 4 15-7320BR Automotive Style, Type C, 1/4" Bdy, 1/4" NPT F Coupler
- 4 15-7320 Automotive Style, Type C, 1/4" Bdy, 1/4" NPT F Coupler
- 4 15-7324 Automotive Style, Type C, Bdy 1/4" NPT M
- 4 15-7334 Automotive Style, Type C, 1/4" Bdy 1/4" NPT F
- 4 15-7566 Dual Foot Chuck, Angled
- 4 15-7568 Dual Foot Chuck, Straight-On Tilt Lock

QUALITY YOU DEPEND ON!  
THE NAME YOU TRUST!



# NUMERICAL INDEX



PART NUMBER	PAGE NUMBER	PART NUMBER	PAGE NUMBER	PART NUMBER	PAGE NUMBER	PART NUMBER	PAGE NUMBER	PART NUMBER	PAGE NUMBER
11-000	10	11-455	17	11-672	10	11-882	16	12-219-5.25	31
11-001	10	11-456	17	11-673	10	11-884	16	12-219-7.50	31
11-002	10	11-457	17	11-674	10	11-886	16	12-220	31
11-003	10	11-458	17	11-675	10	11-950	20	12-221	31
11-004	10	11-459	17	11-676	10	11-950KSC	20	12-222	31
11-005	10	11-460	17	11-679	10	11-950U	20	12-224	31
11-006	10	11-461	17	11-690	10	11-951	20	12-226	31
11-007	10	11-462	17	11-708	9, 13	11-9510	20	12-234	32
11-008	10	11-463	17	11-710	9, 13	11-9510U	20	12-239	32
11-032	10	11-464	17	11-712	9, 13	11-951KSC	20	12-241	32
11-038	10	11-465	17	11-712A	9, 13	11-951U	20	12-311	32
11-045	10	11-466	17	11-714	13	11-952	20	12-312	32
11-055	10	11-467	17	11-720	13	11-95206KSC	20	12-331	32
11-079	10	11-470	18	11-722	13	11-95227KSC	20	12-332	32
11-115	8	11-471	18	11-724	13	11-95238KSC	20	12-333	32
11-115 SB	8	11-472	18	11-725	13	11-952KSC	20	12-335	32
11-115B	8	11-473	18	11-726	13	11-952U	20	12-350	33
11-116	8	11-474	18	11-728	13	11-953	20	12-351	33
11-116 SB	8	11-475	18	11-735	13	11-953KSC	20	12-353	34
11-116B	8	11-476	18	11-740	13	11-953U	20	12-354	34
11-306	8	11-477	18	11-742	13	11-954	20	12-355	34
11-307	8	11-478	18	11-744	13	11-954KSC	20	12-356	34
11-308	8	11-479	18	11-745	13	11-954U	20	12-357	34
11-309	8	11-480	17	11-780	16	11-955	20	12-358	34
11-309 LB	8	11-481	17	11-782	16	11-955KSC	20	12-360	33
11-309 SB	8	11-482	17	11-784	16	11-955U	20	12-360/60	33
11-310	8	11-483	17	11-786	16	11-956	20	12-360JPN	33
11-311	8	11-484	17	11-808	9, 14	11-956KSC	20	12-361	33
11-311 LB	8	11-485	17	11-810	9, 14	11-956U	20	12-361KIT	35
11-311 SB	8	11-488	17	11-812	9, 14	11-957	20	12-361TOTE	35
11-312	8	11-489	17	11-813	9, 14	11-957KSC	20	12-362	33
11-313	8	11-490	17	11-814	14	11-957U	20	12-362KIT	35
11-321	8	11-491	17	11-820	14	11-958	20	12-362TOTE	35
11-321 LB	8	11-492	17	11-820AJL	20	11-958U	20	12-370	33
11-321 SB	8	11-493	17	11-822	14	11-959	20	12-371	33
11-322	8	11-494	17	11-822AJL	20	11-959U	20	12-390	33
11-322 LB	8	11-495	17	11-824	14	12-100	30	12-390/60	33
11-322 SB	8	11-496	17	11-824AJL	20	12-101	30	12-391	33
11-323	8	11-497	17	11-825	14	12-103	30	12-392	33
11-324	8	11-498	17	11-826	14	12-107	30	12-394	33
11-325	8	11-499	17	11-826AJL	20	12-107L	30	12-395	33
11-326	8	11-503	18	11-828	14	12-203	31	12-395/50	33
11-333	21	11-507	18	11-835	14	12-205	31	12-412	7, 14, 30
11-341	21	11-509	18	11-840	14	12-206	31	12-412C	7, 14, 30
11-386	17	11-511	18	11-840AJL	20	12-207	31	12-413	7, 14, 30
11-387	17	11-513	18	11-842	14	12-209	31	12-413C	7, 14, 30
11-388	17	11-515	18	11-844	14	12-210	32	12-414	7, 14, 30
11-413	9	11-517	18	11-844AJL	20	12-213	32	12-414C	7, 14, 30
11-414	9	11-6115	10	11-845	14	12-214	32	12-415	7, 14, 30
11-415	9	11-632	10	11-848AJL	20	12-218	31	12-415C	7, 14, 30
11-4510	17	11-638	10	11-849AJL	20	12-218-5.25	31	12-922	32
11-453	17	11-645	10	11-850AJL	20	12-218-7.50	31	12-923	32
11-454	17	11-655	10	11-880	16	12-219	31	13-201	10

# NUMERICAL INDEX



PART NUMBER	PAGE NUMBER	PART NUMBER	PAGE NUMBER	PART NUMBER	PAGE NUMBER	PART NUMBER	PAGE NUMBER	PART NUMBER	PAGE NUMBER
13-208	10	14-104	27	14-303	40	14-326K	42	14-380	26
13-209	10	14-104A	27	14-303B	40	14-327	43	14-381B	26
13-375	7	14-128A	26	14-303L	40	14-328	43	14-382	45
13-376	7	14-154	27	14-303P	40	14-329	42	14-383	45
13-377	7	14-156	27	14-303R	40	14-330	43	14-383A	45
13-381	7	14-200	30	14-303S	40	14-331	43	14-384	45
13-381SQ	7	14-204	40	14-304T	40	14-332	43	14-384A	45
13-382	7	14-204S	40	14-305	39	14-332W	43	14-385	45
13-382SQ	7	14-211	40	14-306	39	14-333	43	14-385A	45
13-383	7	14-211R	40	14-306A	39	14-334	43	14-386	45
13-620	7, 14, 30	14-212	41	14-307	41	14-335	43	14-386A	45
13-620C	7, 14, 30	14-212R	41	14-307R	41	14-335-38	43	14-390	45
13-621	7, 14, 30	14-213	41	14-307TR	41	14-336	44	14-390A	45
13-621C	7, 14, 30	14-213R	41	14-308	39	14-337	44	14-393	45
13-622	7, 14, 30	14-216	41	14-309	39	14-339	43	14-393A	45
13-622C	7, 14, 30	14-217	41	14-309R	39	14-340	43	14-394	45
13-623	7, 14, 30	14-217H	41	14-310	40	14-341	43	14-394A	45
13-623C	7, 14, 30	14-217R	41	14-310A	40	14-342	43	14-396	45
13-632	30	14-217S	41	14-312T	41	14-343	43	14-396A	45
13-633	30	14-217TR	41	14-313T	41	14-344	43	14-397	45
13-634	30	14-218	40	14-314	39	14-345	43	14-397A	45
13-635	30	14-218H	40	14-314A	39	14-34549	54	14-398	45
13-636	30	14-218R	40	14-314T	39	14-346	43	14-398A	45
13-637	30	14-219	41	14-314W	39	14-347	43	14-399	42
13-638	30	14-220	40	14-315	39	14-348	43	14-401	45
13-670	6	14-221	40	14-315B	39	14-349	43	14-402	45
13-672	6, 12	14-238	41	14-315H	39	14-353	44	14-404	45
13-672C	6, 12	14-251	46	14-317	41	14-353B	44	14-405	45
13-672G	6, 12	14-252	46	14-317P	40	14-354	44	14-408	45
13-673	6, 12	14-2600	59	14-317R	41	14-35440	54	14-411	45
13-673C	6, 12	14-2601	59	14-317S	40	14-354B	44	14-412	45
13-673G	6, 12	14-2602	59	14-317TR	41	14-355	44	14-421	22
13-674	6, 12	14-2603	59	14-318	42	14-355B	44	14-422	22
13-674C	6, 12	14-2605	59	14-318H	42	14-356	44	14-423	22
13-674G	6, 12	14-2609	59	14-318R	42	14-356B	44	14-430	21
13-675	6, 12	14-2610	59	14-318S	42	14-359	43	14-434	21
13-675C	6, 12	14-2617	59	14-319	42	14-360	43	14-435	21
13-675G	6, 12	14-2621	59	14-319DX	42	14-364	44	14-438	22
13-774C	12	14-2650	59	14-319LS	42	14-365	44	14-449	21
13-775C	12	14-2651	59	14-319LSQ	42	14-367	44	14-450	21
13-788	18	14-2652	59	14-319LST	42	14-368	44	14-451	21
14-004	26	14-2653	59	14-320	43	14-371	44	14-452	21
14-008	26	14-2655	59	14-320S	43	14-373	44	14-453	21
14-008-1	99	14-2659	59	14-321	44	14-374	44	14-454	21
14-032	26	14-2660	59	14-321S	44	14-374A	44	14-461	22
14-100	27	14-2667	59	14-312THD	41	14-375	44	14-462	22
14-100GAL	27	14-2671	59	14-322	44	14-375A	44	14-463	22
14-101	27	14-298	38	14-323	44	14-376	44	14-464	22
14-101A	27	14-300	39	14-324	43	14-376A	44	14-465	22
14-101B	27	14-301	39	14-324C	43	14-377	44	14-466	22
14-101GAL	27	14-301A	39	14-324L	43	14-377A	44	14-470	24
14-102	27	14-302	39	14-324S	43	14-378	29	14-470-1	25
14-103	27	14-302R	39	14-325	42	14-378L	29	14-470-2	25

PART NUMBER	PAGE NUMBER	PART NUMBER	PAGE NUMBER	PART NUMBER	PAGE NUMBER	PART NUMBER	PAGE NUMBER	PART NUMBER	PAGE NUMBER
14-470-3	25	14-653	5	14-822	46	14-861B	65	14-919	63
14-470-4	25	14-657	11	14-823	46	14-862 1/2	64	14-921	37
14-470-5	25	14-699	28	14-824	46	14-862 12/1.25	64	14-921-3	37
14-470-6	25	14-700	28	14-825	46	14-862 12/1.50	64	14-921-4	37
14-470-7	25	14-700E	28	14-830	50	14-863A	65	14-921-5	37
14-470-8	25	14-701	28	14-835	50	14-863 14/1.50	64	14-921-6	37
14-470B	25	14-701E	28	14-840	50	14-863 14/2.00	64	14-924	37
14-470H	25	14-705	28	14-840A	50	14-863 9/16	64	14-931	62
14-4700TR	24	14-706	28	14-845	46	14-864 12/1.50	64	14-932	62
14-470T	24	14-708	28	14-845A	46	14-864 12/1.75	64	14-936	57
14-470TB	25	14-708E	28	14-846	46	14-864 14/1.50	64	14-939	57
14-470TH	25	14-711	29	14-846A	46	14-864 14/2.00	64	14-941	61
14-471	25	14-712	29	14-847	46	14-864 9/16	64	14-942	61
14-471H	25	14-713	29	14-847A	46	14-865 1/2	64	14-943	61
14-471S	25	14-720	29	14-848	46	14-865 12/1.25	64	14-944	61
14-472	25	14-721	29	14-850 1/2	64	14-865 12/1.50	64	14-945	61
14-472H	25	14-725	28	14-850 12/1.25	64	14-865 14/1.50	64	14-94725-40	57
14-472S	25	14-725E	28	14-850 12/1.50	64	14-865A	65	14-94730-40	57
14-473	25	14-740	28	14-850 12/1.75	64	14-865B	65	14-94735-40	57
14-473H	25	14-748	29	14-850 14/1.50	64	14-890 1/2	65	14-94750-40	57
14-473S	25	14-748E	29	14-850 14/2.00	64	14-890 12/1.25	65	14-955	29
14-474	25	14-749	29	14-850 7/16	64	14-890 12/1.50	65	14-956	29
14-474S	25	14-749E	29	14-850 9/16	64	14-890 14/1.50	65	14-958	62
14-475	25	14-751	28	14-854 1/2	65	14-890 7/16	65	14-959	62
14-475S	25	14-752	28	14-854 12/1.25	65	14-891 1/2	65	14-960	62
14-476S	25	14-753	28	14-854 12/1.50	65	14-891 12/1.50	65	14-9682	60
14-478	24	14-753PM	28	14-854 14/1.50	65	14-891 12/1.75	65	14-969	60
14-490	27	14-754	27	14-854 7/16	65	14-891 14/1.50	65	14-9691	60
14-511	26	14-754GAL	27	14-857 1/2	64	14-891 14/2.00	65	14-969Y	60
14-512	26	14-755	29	14-857 12/1.25	64	14-892 1/2	65	14-970	60
14-513	26	14-756	27	14-857 12/1.50	64	14-892 12/1.50	65	14-9702	60
14-514	26	14-757	27	14-857 12/1.75	64	14-892 12/1.75	65	14-970G	60
14-515	26	14-758	27	14-857 14/1.50	64	14-892 14/1.50	65	14-971	60
14-516	26	14-758GAL	27	14-857 7/16	64	14-892 14/2.00	65	14-9711	61
14-550	27	14-760	27, 42	14-858 1/2	64	14-893 12/1.75	65	14-972	61
14-551	39	14-765	27	14-858 12/1.50	64	14-893 14/1.50	65	14-972R	61
14-552	39	14-767	27	14-858 12/1.75	64	14-893 14/2.00	65	14-972W	61
14-553	39	14-771	26	14-858 14/1.50	64	14-900	57	14-973	61
14-554	39	14-772	26	14-858 14/2.00	64	14-900-1	57	14-973-2	61
14-555	39	14-802	43	14-858 9/16	64	14-901	57	14-974	61
14-556	39	14-810	46	14-859 12/1.50	64	14-901-1	57	14-975	61
14-557	39	14-811	46	14-859 12/1.75	64	14-901-2	57	14-976	61
14-600	51	14-812	46	14-859 14/1.50	64	14-902	57	14-977	61
14-603	4	14-813	46	14-859 14/2.00	64	14-902-1	57	14-978	62
14-604	4	14-814	46	14-859 9/16	64	14-902-2	57	14-979	62
14-605	11	14-815	46	14-860 12/1.75	64	14-904	57	14-980	56
14-607	51	14-816	46	14-860 14/1.50	64	14-905	57	14-982	62
14-613	4	14-817	46	14-860 14/2.00	64	14-906	57	14-983	62
14-614	51	14-818	46	14-861 1/2	64	14-907	57	14-986	56
14-650	11	14-819	46	14-861 12/1.25	64	14-907R	57	14-987	36
14-651	5	14-819Q	46	14-861 12/1.50	64	14-909	57	14-987-1	36
14-652	5	14-820	46	14-861 12/1.75	64	14-916	54	14-987-4	36, 37
14-652BOX	51	14-821	46	14-861A	65	14-918	63	14-988	36

PART NUMBER	PAGE NUMBER	PART NUMBER	PAGE NUMBER	PART NUMBER	PAGE NUMBER	PART NUMBER	PAGE NUMBER	PART NUMBER	PAGE NUMBER
14-989	36	15-019	99	15-4441	115	15-572	112	15-7130	116
14-989A	36	15-020	99	15-4454	115	15-573	112	15-7130BR	116
14-990	55	15-0211	101	15-4455	115	15-5730	108	15-7132	116
14-991	55	15-0212	101	15-4458	115	15-5733	108	15-7132BR	116
14-992	55	15-0213	101	15-4559-2	112	15-5734	108	15-7150	116
14-993	55	15-0216	101	15-4579	115	15-5735	108	15-7150BR	116
14-994	55	15-026	99	15-4580	113	15-5743	108	15-7151	117
14-995	55	15-0308	101	15-4600	112	15-5744	108	15-7152	117
14-996	55	15-0314	101	15-4660	114	15-5745	108	15-7153	117
14-997	55	15-0317	101	15-4895	114	15-5746	108	15-7154	117
14-998	55	15-0320	101	15-4901	115	15-5754	108	15-7155	117
14-999	55	15-0324	101	15-4904	111	15-5755	108	15-7156	117
14-CH5	56	15-0378	101	15-4911	115	15-5766	108	15-7157	117
14-LMC1000	23	15-0383	99	15-4915	115	15-5767	108	15-7158	117
14-LMC200	23	15-045	100	15-492	115	15-5771	109	15-7170	90, 117
14-LMC2000	23	15-0472	99	15-4922	111	15-5772	109	15-7171	90, 117
14-LMC400B	23	15-0474	99	15-4923	111	15-5773	109	15-7180	90, 117
14-T11E	52	15-050	100	15-4924	115	15-5780	109	15-7181	90, 117
14-T11EH	52	15-0708	99	15-4925	111	15-5790	109	15-7306	118
14-T19	53	15-0716	99	15-4927	111	15-5820	109	15-7307	118
14-T19A	53	15-0732	99	15-493	115	15-5830	109	15-7310	118
14-T20	53	15-1021	103	15-4932	111	15-5840	109	15-7310BR	118
14-T20A	53	15-1022	103	15-4933	111	15-5850	109	15-7320	118
14-T21F	53	15-1023	103	15-4934	115	15-5860	109	15-7320BR	118
14-T21R	53	15-1027	103	15-4935	111	15-5870	109	15-7321	118
14-T24B	52	15-1031	102	15-496	113	15-5920	104	15-7321BR	118
14-T26B	52	15-1045	102	15-4961	113	15-5922	104	15-7324	118
14-T2X	53	15-1045B	102	15-497	113	15-5923	104	15-7324BR	118
14-T34RH	52	15-1075	103	15-4971	113	15-5925	107	15-7325	118
14-T45A	53	15-1078	103	15-498	113	15-5925-3	107	15-7326	118
14-T45A-2000K	53	15-1313	102	15-501	104	15-5926	107	15-7327	119
14-T45HF	53	15-1313B	102	15-503	104	15-593	106	15-7327BR	119
14-T46A	53	15-20008	111	15-507	105	15-594	106	15-7328	119
14-T48A	53	15-2173	111	15-5318	106	15-5950	107	15-7328BR	119
14-T57	52	15-3174	114	15-5324	42, 107	15-5950-3	107	15-7329	119
14-T68	53	15-3602	114	15-5336	42, 107	15-604	114	15-7334	118
14-T6A	53	15-3605	114	15-5452	112	15-6045	114	15-7334BR	118
14-T95	52	15-3606	114	15-5504	104	15-7020	109	15-7335	119
14-T9A	53	15-3607	114	15-5505	104	15-7021	109	15-7336	119
14-TG11D	52	15-390	100	15-552	101	15-7052	121	15-7338	119
14-TG11E	52	15-394	100	15-553	101	15-7052BR	121	15-7339	119
14-TG11EH	52	15-4032	115	15-5601	105	15-7054	121	15-7340	119
14-TG35	52	15-4036	115	15-5602	105	15-7054BR	121	15-7341	119
14-TX9	52	15-412	112	15-5603	105	15-7110	116	15-7342	119
15-001	100	15-413	112	15-5605	105	15-7111	116	15-7430	120
15-003	100	15-4134	112	15-5606	105	15-7120	116	15-7430BR	120
15-004	100	15-4142	112	15-5607	105	15-7120BR	116	15-7440	120
15-005	100	15-4152	112	15-5608	105	15-7122	116	15-7461	120
15-011	100	15-416	112	15-5610	105	15-7122BR	116	15-7465	120
15-012	99	15-418	112	15-5611	105	15-7124	116	15-7472	120
15-014	100	15-4184	112	15-5612	105	15-7125	116	15-7510	121
15-016	100	15-4232	112	15-5613	106	15-7125BR	116	15-7510BR	121
15-018	99	15-4252	112	15-5620	106	15-7126	116	15-7511	121



PART NUMBER	PAGE NUMBER	PART NUMBER	PAGE NUMBER	PART NUMBER	PAGE NUMBER	PART NUMBER	PAGE NUMBER	PART NUMBER	PAGE NUMBER
15-7511BR.....	121	16-1329T.....	55	17-1317BC.....	86	17-20217AK.....	69	17-3262.....	92
15-7521.....	121	16-1332T.....	55	17-1317C.....	86	17-20221AK.....	69	17-327.....	92
15-7521BR.....	121	16-1333T.....	55	17-144.....	66	17-20223AK.....	69	17-328.....	92
15-7530.....	121	16-1335T.....	55	17-144-2.....	66	17-20720AK.....	69	17-332.....	91
15-7531.....	121	16-1345T.....	55	17-144-4.....	66	17-20725AK.....	69	17-3322.....	91
15-7531BR.....	121	16-1349T.....	55	17-161A.....	72	17-21101.....	73	17-332P.....	91
15-7566.....	104	16-1451T.....	55	17-167A.....	72	17-21102.....	73	17-333.....	91
15-7568.....	104	16-1457T.....	55	17-168.....	72	17-21103.....	73	17-334.....	91
15-7568B.....	104	16-225.....	55	17-169.....	72	17-212.....	93	17-335.....	91
15-7569.....	104	16-229.....	55	17-169T.....	77	17-213.....	93	17-336.....	92
15-803.....	110	16-233.....	55	17-170.....	72	17-21303.....	68	17-337.....	92
15-807.....	110	16-235.....	55	17-171.....	83	17-21305.....	68	17-338.....	92
15-808.....	110	16-239.....	55	17-172.....	83	17-21306.....	68	17-340.....	92
15-809.....	110	16-245.....	55	17-173.....	72, 83	17-221.....	93	17-342.....	93
15-810.....	110	16-249.....	55	17-174.....	83	17-222.....	91	17-3421.....	93
15-813.....	110	16-251.....	55	17-175.....	83	17-223.....	91	17-343.....	93
15-815.....	110	16-257.....	55	17-176.....	83	17-224.....	92	17-345.....	93
15-817.....	110	16-263.....	55	17-177.....	83	17-225.....	92	17-347.....	93
15-820.....	110	16-295.....	58	17-178.....	83	17-226.....	92	17-3471.....	93
15-823.....	110	16-299.....	58	17-181.....	83	17-227.....	93	17-348.....	93
15-825.....	110	16-301.....	58	17-20005AK.....	69	17-228.....	93	17-349.....	93
15-829.....	110	16-302.....	58	17-20006AK.....	69	17-229.....	93	17-355.....	91
15-830.....	110	16-303.....	58	17-20007AK.....	69	17-231.....	93	17-356.....	91
15-833.....	110	16-304.....	58	17-20008.....	69	17-232.....	91	17-361.....	92
15-835.....	110	16-305.....	58	17-20008-50.....	69	17-233.....	91	17-363.....	92
15-839.....	110	16-306.....	58	17-20008C.....	69	17-234.....	92	17-364.....	92
15-841.....	110	16-308.....	58	17-20009AK.....	69	17-235.....	92	17-412-1-50.....	74
15-843.....	110	16-310.....	58	17-20010AK.....	69	17-236.....	92	17-412-50.....	74
15-844.....	110	16-312.....	58	17-20011AK.....	69	17-237.....	93	17-413-1-50.....	74
15-845.....	110	16-314.....	58	17-20012AK.....	69	17-239.....	93	17-413-50.....	74
15-846.....	110	16-316.....	58	17-20013AK.....	69	17-241.....	92	17-414-1-50.....	74
15-847.....	110	16-401.....	63	17-20014AK.....	69	17-242.....	92	17-414-50.....	74
15-848.....	110	16-402.....	63	17-20015AK.....	69	17-246.....	91	17-415-50.....	74
15-905.....	102	16-403.....	63	17-20016AK.....	69	17-251.....	91	17-416.....	75
15-905CD.....	102	16-412.....	63	17-20018.....	69	17-252.....	91	17-416L.....	75
15-906.....	103	16-413.....	63	17-20020.....	69	17-253.....	91	17-417.....	75
15-9061.....	103	16-414.....	63	17-20020AK.....	69	17-254.....	91	17-418-1-50.....	74
15-908.....	102	16-416.....	63	17-20028AK.....	69	17-255.....	91	17-418-50.....	74
15-909.....	102	16-422.....	63	17-20035AK.....	69	17-256.....	91	17-41MS-00.....	77
15-910.....	102	16-428.....	63	17-20036AK.....	69	17-261.....	92	17-423-50.....	74
15-9105.....	102	16-441.....	63	17-20045.....	69	17-262.....	92	17-425-50.....	74
15-911.....	102	16-445.....	63	17-20046.....	69	17-263.....	92	17-428.....	75
15-951.....	103	17-1031C.....	86	17-20096AK.....	69	17-264.....	92	17-429.....	75
15-952.....	103	17-1045BC.....	86	17-20107AK.....	69	17-312.....	93	17-430.....	75
15-955.....	103	17-1045C.....	86	17-20198AK.....	69	17-313.....	93	17-43001.....	66
15-9825.....	98	17-1045RCL.....	86	17-20201AK.....	69	17-320.....	91	17-43006.....	66
16-120JM.....	55	17-1047.....	86	17-20202AK.....	69	17-322.....	91	17-43011.....	66
16-1220TG.....	55	17-1075.....	86	17-20203AK.....	69	17-3222.....	91	17-43012.....	66
16-1224TG.....	55	17-1085.....	86	17-20204AK.....	69	17-322P.....	91	17-43013.....	66
16-122JM.....	55	17-113.....	74	17-20206AK.....	69	17-323.....	91	17-43014.....	66
16-124JM.....	55	17-115.....	74	17-20207AK.....	69	17-324.....	91	17-43016.....	66
16-125T.....	55	17-115MS-27.....	77	17-20211AK.....	69	17-325.....	91	17-43017.....	66
16-1325T.....	55	17-1313C.....	86	17-20216AK.....	69	17-326.....	92	17-43018.....	66

PART NUMBER	PAGE NUMBER	PART NUMBER	PAGE NUMBER	PART NUMBER	PAGE NUMBER	PART NUMBER	PAGE NUMBER	PART NUMBER	PAGE NUMBER
17-43019	66	17-50342	69	17-553V	78	17-580-14	82	17-60MS-27	77
17-43020	66	17-50344	69	17-554	75	17-581	82	17-610	83
17-43024	66	17-50346	69	17-554C	78	17-581A	82	17-6301	84
17-452	93	17-50390	69	17-554D	78	17-581BP	82	17-6306	84
17-4521	93	17-50391	69	17-554V	78	17-581P	82	17-6308	84
17-454	93	17-50395	69	17-555	75	17-582	82	17-645-4	80
17-489	73, 81	17-50396	69	17-555C	78	17-582-AS1	82	17-645-4 1/2	80
17-490	81	17-50397	69	17-555D	78	17-582-AS2	82	17-645-6	80
17-490HT	81	17-50399	69	17-555E	78	17-582P	82	17-645-9	80
17-490L	81	17-503FT	85	17-555V	78	17-583	82	17-650	80
17-490T	73, 81	17-504	85	17-556-36	78	17-583P	82	17-650C	80
17-490TY	73, 81	17-504C	85	17-5565	85	17-584	79	17-651	80
17-491D	81	17-504F	85	17-5565RK	85	17-584B	79	17-653	80
17-491E	81	17-504FC	85	17-5565RS	85	17-585	79	17-6566BC	84
17-491S	81	17-505	85	17-5567	85	17-585/110	79	17-6566C	84
17-491T	81	17-505F	85	17-556D	78	17-586	79	17-6566FT	84
17-492	81	17-506	85	17-556E	78	17-586-10	79	17-6566RK	85
17-492-1	73, 81	17-509	77	17-556V	78	17-586A	79	17-6568BC	84
17-492B-1	81	17-510	77	17-557	82	17-586B	79	17-6568BL	84
17-492G	81	17-511	77	17-557D	78	17-586C	79	17-6568BRK	85
17-492G-1	73, 81	17-520	76	17-558	77	17-586S	79	17-6568C	84
17-492L-1	73, 81	17-521	76	17-559	75	17-587	79	17-6568FT	84
17-492LG-1	73, 81	17-522	76	17-560	75	17-587A	79	17-6568L	84
17-492T-1	73, 81	17-542	78	17-560A	75	17-587S	79	17-6568RK	85
17-493	81	17-543	78	17-560L	75	17-588	79	17-6568RS	85
17-493B	81	17-543C	78	17-561	75	17-589	80	17-6569	84
17-493BP	81	17-543D	78	17-562	75	17-590	79	17-658	80
17-493G	81	17-543E	78	17-563	82	17-591	79	17-660	79
17-493N	81	17-543T-U	76	17-564	82	17-591C	79	17-662	80
17-493NP	73, 81	17-544	78	17-565	82	17-593	79	17-670	80
17-493NPB	81	17-544C	78	17-570C	76	17-593L	79	17-670C	80
17-493P	73, 81	17-544D	78	17-570T	76	17-594	79	17-685	80
17-494	75	17-545	78	17-571T	76	17-595	79	17-687	80
17-494T	73	17-545D	78	17-572-B19	76	17-600HP-50	74	17-688	80
17-495	75	17-545E	78	17-572-D12	76	17-601	73	17-694	80
17-495L	75	17-546	75	17-572-F19	76	17-602	83	17-697	80
17-496	82	17-546-36	78	17-572T	76	17-602HP-50	74	17-698	80
17-496B	82	17-546D	78	17-572T-U	76	17-604	83	17-70MS-27	77
17-497	82	17-546E	78	17-573A	77	17-604B	83	17-763	88
17-497B	82	17-546V	78	17-573T	76	17-605	83	17-764	88
17-498	82	17-547	77	17-574-C26	76	17-605-24	83	17-765	88
17-499	82	17-547A	77	17-574-E16	76	17-605C	83	17-774	88
17-500A	76	17-547D	78	17-574-E28	76	17-606	83	17-774-3/8	88
17-500AL	76	17-548	77	17-574T	76	17-606P	83	17-775	88
17-500B	76	17-549	77	17-575T	76	17-606R	83	17-775-3/8	88
17-500T	76	17-550	75	17-576	77	17-606T	83	17-775N	88
17-501	85	17-551	77	17-576A	77	17-607	39	17-801HP-50	74
17-501N	85	17-552	79	17-577	77	17-607C	39	17-802HP-50	74
17-501-OV	76	17-552V	78	17-577G	77	17-607D	39	17-80MS-27	77
17-501T	76	17-553	75	17-577H	77	17-607T	39	17-840	80
17-502	84	17-553C	78	17-578	77	17-608	83	17-850	80
17-503	85	17-553D	78	17-579	81	17-609	83	17-856	80
17-50340	69	17-553E	78	17-580	82	17-609P	83	17-859	80

PART NUMBER	PAGE NUMBER	PART NUMBER	PAGE NUMBER	PART NUMBER	PAGE NUMBER	PART NUMBER	PAGE NUMBER
17-860	80	17-974	89	18-363	47	18-667	47
17-900	86	17-9743	89	18-364	47	18-669	47
17-907	85	17-975	89	18-365	47	18-670	47
17-907M	85	17-9751	89	18-366	47	18-733	49
17-907R	85	17-976	89	18-367	47	18-766SQ	49
17-908C	86	17-977	89	18-368	47	18-771	49
17-909C	86	17-977R	89	18-369	47	18-773	49
17-90MS-27	77	17-978	89	18-370	47	18-777	49
17-910C	86	17-978A	89	18-371	47	18-803	50
17-910E	86	17-9784	89	18-373	47	18-804	50
17-910S	86	17-979	89	18-410	49	18-805	50
17-911C	86	17-990	89	18-411	49	18-833	50
17-911S	86	17-990F	89	18-412	49	18-866SQ	50
17-912C	86	17-991	87	18-413	49	18-869	50
17-914	86	17-992	87	18-414	49	18-872	50
17-916	86	17-993	87	18-415	49	18-881	50
17-917	86	17-996	29	18-416	49	19-122	67
17-920	87	17-997	29	18-417	48, 49	19-130	73
17-920H	87	18-031	47	18-418	49	19-231	56
17-921	87	18-032	48	18-419	48, 49	19-260	83
17-922	87	18-033	48	18-421	48, 49		
17-926	87	18-034	48	18-422	48, 49		
17-927	87	18-035	49	18-423	48		
17-935	87	18-036	49	18-426	49		
17-935H	87	18-037	47	18-427	49		
17-936	87	18-038	47	18-460	48		
17-936H	87	18-061	49	18-461	48		
17-941	88, 107	18-081	50	18-462	48		
17-942	88, 107	18-101	48, 49, 50	18-463	48		
17-942T	88, 107	18-102	50	18-464	48		
17-944	88, 107	18-120	50	18-465	48		
17-944 USA	88	18-130	50	18-466	48		
17-944-3/8 USA	88	18-131	50	18-467	48		
17-945	88, 107	18-132	50	18-468	48		
17-945 USA	88	18-140	50	18-469	48		
17-945-3/8 USA	88	18-141	50	18-470	48		
17-946 USA	88	18-310	48	18-471	48		
17-947 USA	88	18-311	48	18-473	48		
17-948 USA	88	18-312	48	18-517	49		
17-949 USA	88	18-313	48	18-519	49		
17-952	89	18-314	48	18-521	49		
17-966	88, 107	18-315	48	18-522	49		
17-967	88, 107	18-316	48	18-523	49		
17-967N	88	18-317	48	18-565	49		
17-968	88	18-318	48	18-566	49		
17-969	88	18-319	48	18-567	49		
17-970	88	18-321	48	18-568	49		
17-971	89	18-322	48	18-569	49		
17-972	89	18-326	48	18-570	49		
17-972R	89	18-327	48	18-617	47		
17-973	89	18-360	47	18-619	47		
17-9731	89	18-361	47	18-621	47		
17-9735	89	18-362	47	18-666	47		

Distributed by:



**U.S. Plant and International Headquarters**

100 Enterprise Drive  
Newcomerstown, Ohio 43832 U.S.A.

Phone (740) 498-8324 | 800-438-3302

Fax (740) 498-8325

[www.31inc.com](http://www.31inc.com) | email: [info@31inc.com](mailto:info@31inc.com)



[www.31inc.com](http://www.31inc.com)



[www.tpmsnetwork.com](http://www.tpmsnetwork.com)



[www.smartsensorupdate.com](http://www.smartsensorupdate.com)