

Lisle®



The Innovator in Specialty Tools

807 East Main Street • P.O. Box 89 • Clarinda, IA 51632

712-542-5101 • Fax 712-542-6591

www.lislecorp.com



10000 10400 10500 BRAKE HONES

10000 3-Stone, Range 27/32" to 2".

10400 3-Stone Disc Brake Hone, Range 1-1/2" to 3-1/8".

10500 2-Stone Hone, Range 11/16" to 2-1/2".

Controlled pressure makes it possible to polish or hone with just one stone grit. Square ends of stones hone to the end in step-cut and blind-end cylinders. 220 grit stones are 1-1/8" long on 10000 & 10500; 400 grit 10400 stones are 1". Flexible driver provides good stability.

10000 Three-Stone Brake Cylinder Hone. Skin-Packed. Shipping wt. 3 oz.

10050 Set Replacement Stones for 10000. Skin-Packed. Shipping wt. 1 oz.

10400 Disc Brake Hone. Skin-Packed. Shipping wt. 3 oz.

10490 Set Replacement Stones for 10400. Skin-Packed. Shipping wt. 1 oz.

10500 Two-Stone Brake Cylinder Hone. Skin-Packed. Shipping wt. 3 oz.

10550 Set Replacement Stones for 10500. Skin-Packed. Shipping wt. 1 oz.

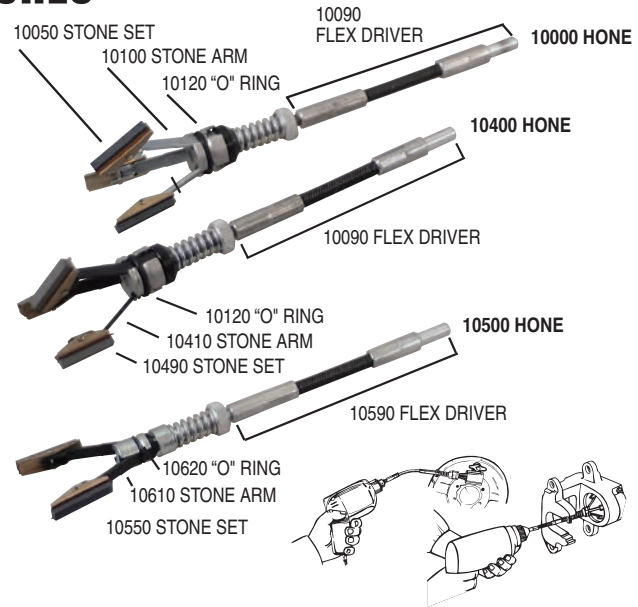

24300 SPEEDY BRAKE PAD SPREADER

25750 DUAL PISTON BRAKE PAD SPREADER

29100 QUICK QUAD PAD SPREADER

Compresses Brake Pistons in Seconds.

Compress disc brake pistons easily. Squeeze the handle and the fast acting plunger to compresses disc brake pistons in seconds. 25750 Dual Piston Brake Pad Spreader compresses both pistons simultaneously. 29100 Quick Quad Pad Spreader simultaneously compresses all pistons on four piston brake calipers. Can be used while four piston caliper is still attached to the vehicle hub. Makes brake pad replacement a quick and easy job.

24300 Speedy Brake Pad Spreader. Hang Card. Shipping wt. 1 lb. 11 oz.

25750 Dual Piston Brake Pad Spreader. Hang Card. Shipping wt. 2 lbs. 3 oz.

29100 Quick Quad Pad Spreader. Hang Card. Shipping wt. 2 lbs. 13 oz.



24300 & 29100:
U.S. Pat No. 6,874,217
25750:
U.S. Pat No. 7,076,850
29100:
U.S. Pat No. 8,393,063

24400 DISC BRAKE PAD SPREADER

For Installing Pads on Most Domestic and Import Cars and Light Trucks.

Makes changing pads an easy job. Tool compresses disc brake piston for easy pad installation.

24400 Disc Brake Pad Spreader. Skin-Packed. Shipping wt. 11 oz.

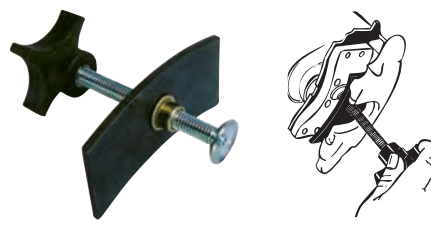

29120 11 PT. TRUCK BRAKE CALIPER SOCKET

11 Point Socket for Air Disc Brake Caliper Adjustment.

Works on Bendix ADB 22X, ADB 225, SN6, SN7, SK7 air disc brake calipers.

29120 11pt Truck Brake Caliper Socket. Hang Tag. Shipping wt. 2 oz.



29350 COMBINATION DISC BRAKE KIT

One Tool Helps Make Installing New Pads on Front and Rear Brakes Quick and Easy.

Designed to work on single piston disc brakes that require the piston to be rotated back into the caliper as well as pistons that are pushed. Includes two, double-sided two pin adapters along with a pinless pushing adapter. Magnets and pins on back of pushing adapter allow use of other two pin adapters. Shaft may be rotated both directions depending on the vehicle application. Turn with 9/16" wrench or socket.

29350 Combination Disc Brake Kit. Molded Case. Shipping wt. 2 lb. 3 oz.

25080 1-1/2" Adapter

25110 1-5/8" Adapter

29410 Pinless Adapter

Applications:

Adapter 1A - 1-1/2" (narrow pins) most Hondas, Mazdas, Dodge, Mitsubishi and 1-1/2" GMs
 Adapter 1B - 1-1/2" (wide pins) most Fords, Toyotas and some Pontiac
 Adapter 2A - 1-5/8" most Nissans/Datsuns and Subaru
 Adapter 2B - 1-5/8" Mazda 3, some Jaguar and some Mini Cooper
 Pinless Adapter - Front brakes that do not require the piston to be rotated back into the caliper



YouTube



U.S. Pat No. 9,683,620

25000 UNIVERSAL DISC BRAKE CALIPER TOOL

For Rotating the Brake Piston Back Into the Caliper to Provide Clearance for New Pads. New Second Side on Adapter 2B 1-5/8" Has Narrow Pins to Fit Mazda 3 Applications.

Includes 5 adapters (available individually) for use in both 2 and 4-wheel disc brake assemblies of most domestic and import cars. Tool may be used "on" or "off" the car. A real time saver that makes this tough job easy. Helps prevent damage to the piston and boot.

NOTE: Some pistons turn clockwise while others turn counter-clockwise; consult your shop manual for the car you are servicing. For the counter-clockwise rotation the 1" Hex Nut must be turned at a faster rate of rotation in order to keep the adapter engaged with the piston.

25000 Universal Disc Brake Caliper Tool. Molded Case. Shipping wt. 5 lbs.

25040 Backing Plate.

25080 1-1/2" Adapter.

25110 1-5/8" Adapter.

25130 1-7/8" Adapter.

25150 2-1/8" Adapter.

25170 2-1/2" Adapter.



25110 - SIDE (2B) FITS MAZDA 3, SOME MINI COOPER AND SOME JAGUAR APPLICATIONS

28600 DISC BRAKE PISTON TOOL

Rotates Piston Back Into the Caliper When Replacing Pads.

A sixth side has been added and one side has been modified. This tool now fits more applications. Used on vehicles with four wheel disc brakes. Fits most domestic and some import applications. Push and turn tool to rotate piston into caliper. Use with 3/8" drive ratchet and extension.

28600 Disc Brake Piston Tool. Skin-Packed. Shipping wt. 4 oz.

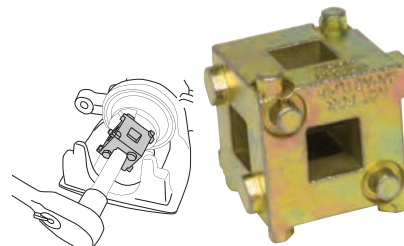

6 DIFFERENT PISTON CONFIGURATIONS

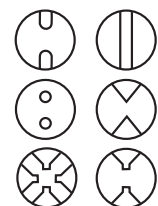

12550 BRAKE CALIPER BIT SET

For Servicing Disc Brakes.

Three 3/8" square drive sockets with hex bits to remove and replace floating caliper mounting bolts. 3/8" and 8mm hex bits for GM and 1/4" hex bit for Ford. Also available individually.

12550 Brake Caliper Socket Set. Skin-Packed. Shipping wt. 7 oz.

12450 1/4" Brake Caliper Socket. Skin-Packed. Shipping wt. 2 oz.

12560 8mm Brake Caliper Socket. Skin-Packed. Shipping wt. 2 oz.

12570 3/8" Brake Caliper Socket. Skin-Packed. Shipping wt. 2 oz.



12570



12560



12450

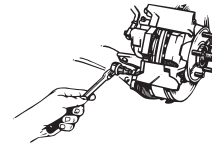

33900 33960 33920 7MM, 9MM, 10MM HEX BRAKE CALIPER BITS

For Removing and Installing Disc Brake Calipers.

Hex bits remove and install floating caliper mounting bolts. 7mm hex is used for some Chrysler, Audi, Ford, Jeep, Lincoln and Volkswagen applications. 9mm hex fits Ford Expedition '06-'08, Ford Escape '06, Mercedes ML320 CDI and other vehicles. 10mm hex is used for some Chevrolet and GMC van and truck applications. Use with 3/8" drive.

33900 7mm Hex Brake Caliper Bit. Skin-Packed. Shipping wt. 2 oz.

33920 10mm Hex Brake Caliper Bit. Skin-Packed. Shipping wt. 2 oz.

33960 9mm Hex Brake Caliper Bit. Skin-Packed. Shipping wt. 2 oz.

7mm
ACTUAL SIZE



9mm



10mm



33900



33960



33920



27740 BRAKE CALIPER TORX® BIT SET

T-40, T-45, T-50 Sizes for Servicing Disc Brakes.

Three 3/8" square drive Torx bits to fit GM and Ford brake caliper Torx bolts. Also available individually.

27740 Brake Caliper Torx Bit Set. Skin-Packed. Shipping wt. 5 oz.

26620 T-40 Torx Bit. Skin-Packed. Shipping wt. 2 oz.

26630 T-45 Torx Bit. Skin-Packed. Shipping wt. 2 oz.

26640 T-50 Torx Bit. Skin-Packed. Shipping wt. 2 oz.



26620



26630



26640

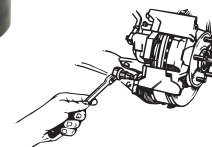

11260 BRAKE SPRING PLIERS

Double Ended Tool for Removing and Installing Brake Springs.

Use plier tips to stretch brake spring. Handle ends remove and install spring over anchor post.

11260 Brake Spring Pliers. Skin-Packed. Shipping wt. 16 oz.



45100 BRAKE SPRING TOOL

Designed for Import Car Brake Return Springs.

This tool removes and installs import brake return springs. Also works on domestic brakes that don't use an anchor pin. Engage brake spring in tool head. Turn handle to lock on spring. Expand spring to install or remove.

45100 Brake Spring Tool. Skin-Packed. Shipping wt. 4 oz.

45140 Tip

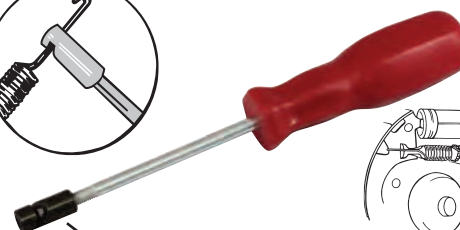
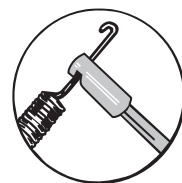

45140 TIP

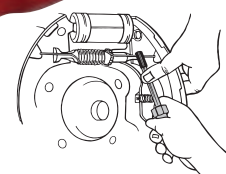

50600 SINGLE-SPRING BRAKE TOOL

Modified Bracket Now Fits 2007 Silverado/Sierra Applications.

Releases Tension on Both Large and Small GM Single Spring Brakes During Servicing. Many GM brakes use a heavy single spring. The 50600 engages the spring and quickly releases the spring tension. The brake can then be disassembled to replace brake shoes, emergency brake cable or service the brake cylinder. Also works on older C & H body vehicles with single brake springs.

50600 Single-Spring Brake Tool. Clam Shell. Shipping wt. 1 lb. 8 oz.

50150 Bracket - Updated Requires 2

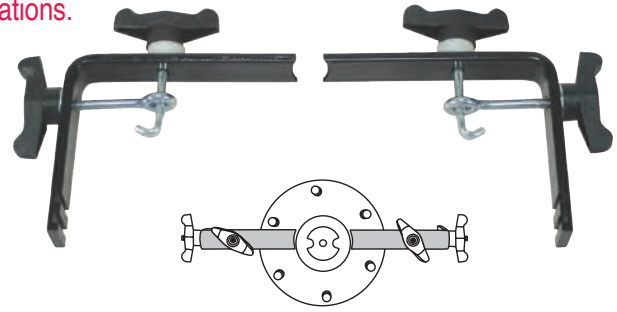

2007 SILVERADO HUB

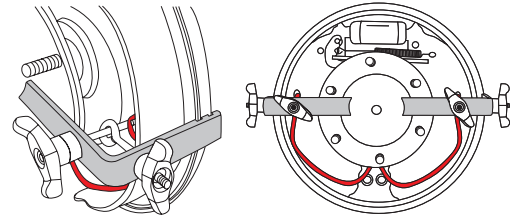

U.S. Pat No. 7,032,280

Applications

Smaller Spring

1991 to current GM H Body
Bonneville, LaSabre
Delta, 88

1995 to current Chevrolet Lumina & Monte Carlo

1992 to current GM C & H Body
Buick Electra
Olds 88
Cadillac Fleetwood
Cadillac DeVille
Chevrolet Lumina APV
Pontiac Trans Sport
Olds Silhouette

Larger Spring

2005 to current Chevrolet Silverado
2004 to current Chevrolet Colorado
Includes 2007 Models

49100 T-HANDLE SINGLE SPRING BRAKE TOOL

Quickly and Easily Releases Tension on Large and Small Single Spring Brakes on GM Vehicles.

The tool design uses the hook to grab onto the spring while the tool tip is used as a fulcrum to pry the spring free. The tool can also be used to re-install the spring.

49100 T-Handle Single Spring Brake Tool. Skin-Packed. Shipping wt. 16 oz.

49140 Replacement Hook and Bolts



YouTube

BRAKE

47400 BRAKE SPRING WASHER TOOL

Fits Both Large and Small Washers.

Troublesome brake shoe retaining spring washers can now be easily removed and then reinstalled. Wide "window" allows better visibility to align the nail and washer slot.

47400 Brake Spring Washer Tool. Skin-Packed. Shipping wt. 4 oz.

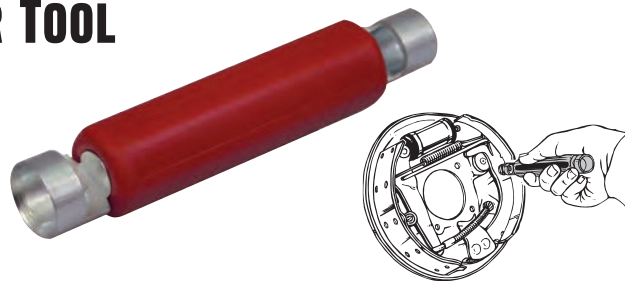

48400 IMPORT CAR BRAKE CLIP TOOL

Designed for Import Cars with Brake Shoe Hold-down Clips.

Removes and installs the brake clip and nail on brake shoes in seconds. Set tool head in the brake clip groove. Push tool to depress brake clip. Turn handle 1/4 turn to disengage clip from nail. Reverse to install.

48400 Import Car Brake Clip Tool. Skin-Packed. Shipping wt. 5 oz.

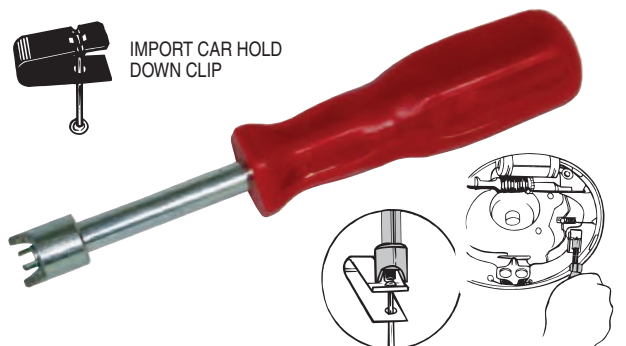

19200 BRAKE BLEEDING KIT

Simple to Use.

Everything needed to quickly bleed brakes with no mess. Plastic bottle collects discharged fluid. Three separate adapters fit the common bleeder screws.

19200 Brake Bleeder. Skin-Packed. Shipping wt. 5 oz.

73090 No. 1 Adapter

73100 No. 2 Adapter

73110 No. 3 Adapter

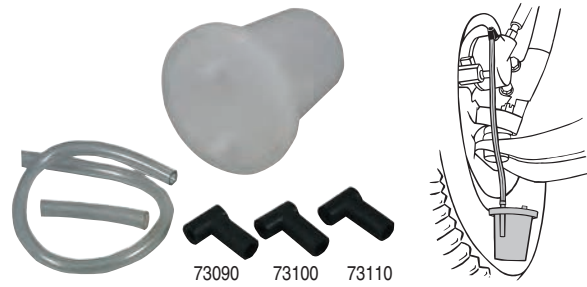

46750 BRAKE SPRING TOOL

Makes it Easy to Remove and Replace Springs.

A spring tool for removing and replacing brake return springs that are set over a post. Heat-treated end fitting engages hook and removes it from the post when the tool is turned clockwise. "Shoe horn" design on the other end makes it easy to slip the spring back over the post. Large handle gives good grip and easy operation.

46750 Brake Spring Tool. Skin-Packed. Shipping wt. 6 oz.

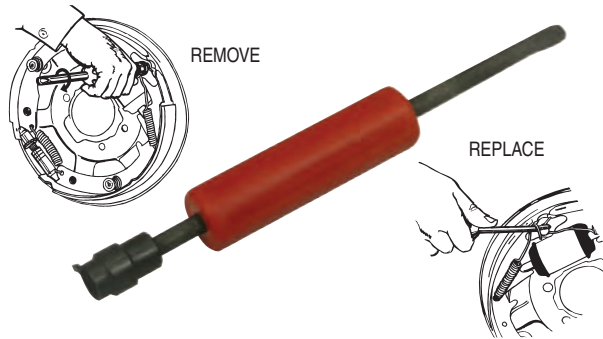

44800 HEAVY-DUTY BRAKE SPRING TOOL

Designed for Larger Brake Springs.

The heavy-duty tool removes and installs larger brake return springs. Works on brakes with or without an anchor pin. Engage brake spring in tool head. Turn rear handle to lock on spring. Expand spring to install or remove. Front handle can be removed when working in tight places.

44800 Heavy-Duty Brake Spring Tool. Skin-Packed. Shipping wt. 8 oz.

44810 Tip

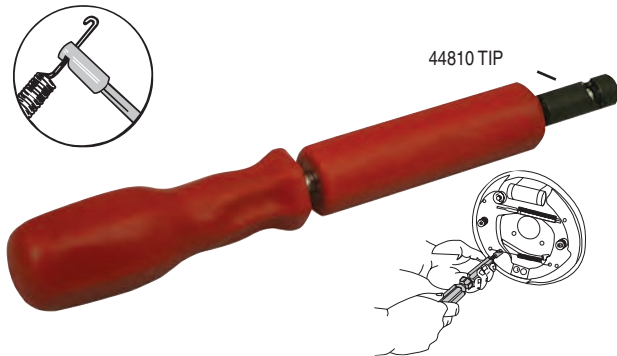

10900 10950 10990 11000 BRAKE BLEEDER WRENCHES

For Bleeding Air From Brake Cylinders With Bleeder Screws.

Double ended tools are offset for easy access.

10900 for 5/16" or 3/8" bleeder screws.

10950 for 1/4" or 3/8" bleeder screws.

10990 for 7mm or 9mm bleeder screws.

11000 for 8mm or 10mm bleeder screws.

10900 5/16" - 3/8" Brake Bleeder Wrench. Skin-Packed. Shipping wt. 4 oz.

10950 1/4" - 3/8" Brake Bleeder Wrench. Skin-Packed. Shipping wt. 4 oz.

10990 7mm - 9mm Brake Bleeder Wrench. Skin-Packed. Shipping wt. 4 oz.

11000 8mm - 10mm Brake Bleeder Wrench. Skin-Packed. Shipping wt. 4 oz.

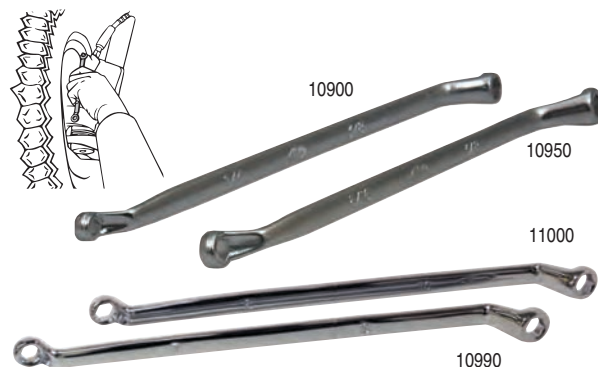

50700 BRAKE ADJUSTMENT TOOL

Speeds Star Wheel Adjusting.

Insert tool through slot in backing plate. Different angle at each end adapts to various makes and models.

50700 Brake Adjustment Tool. Skin-Packed. Shipping wt. 2 oz.



81850 COMBINATION BRAKE LINING THICKNESS GAUGE SET

The 9 Piece Manual Brake Gauge Set Allows Brake Pad Wear to be Accurately and Consistently Measured without Guessing.

Designed to check both straight on or at a 90° angle to the rotor with offset tips so the gauges can be used without removing the wheel or caliper assembly on many applications. Brake lining gauges identify thickness levels for brake lining inspection. Made from durable, flexible acetal. The gauges are color coded to match SAE or Metric recommendations for brake pad replacement. Green (Good): 12mm (.4724"), 10mm (.3937"), 8mm (.3150"). Yellow (Marginal): 6mm (.2362"), 5mm (.1969"), 4mm (.1575"). Red (Replace): 3mm (.1181"), 2mm (.0787").

81850 Combination Brake Lining Thickness Gauge Set. Hang Card. Shipping wt. 2 oz.



Gauges Included:

- 81860 2mm 90°
- 81870 2mm Straight
- 81880 3mm
- 81890 4mm
- 81900 5mm
- 81910 6mm
- 81920 8mm
- 81930 10mm
- 81940 12mm

U.S. Pat No. 9,500,462

83400 TRUCK BRAKE LINING GAUGE SET

The 9 Piece Manual Brake Gauge Set Allows Brake Pad Wear to be Accurately and Consistently Measured without Guessing.

Designed to check both straight on or at a 90° angle to the rotor with offset tips. Brake lining gauges identify thickness levels for brake lining inspection. Made from durable, flexible acetal. Includes 22mm (.8661"), 20mm (.7874"), 18mm (.7087"), 16mm (.6299"), 14mm (.5512"), 12mm (.4724"), 10mm (.3937"), 8mm (.3150") and 6mm (.2362").

83400 Truck Brake Lining Gauge. Hang Card. Shipping wt. 2 oz.

83410 Brake Gauge 6mm/.2362	83420 Brake Gauge 8mm/.3150
83430 Brake Gauge 10mm/.3937	83440 Brake Gauge 12mm/.4724
83450 Brake Gauge 14mm/.5512	83460 Brake Gauge 16mm/.6299
83470 Brake Gauge 18mm/.7087	83480 Brake Gauge 20mm/.7874
83490 Brake Gauge 22mm/.8661	

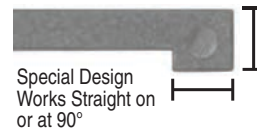
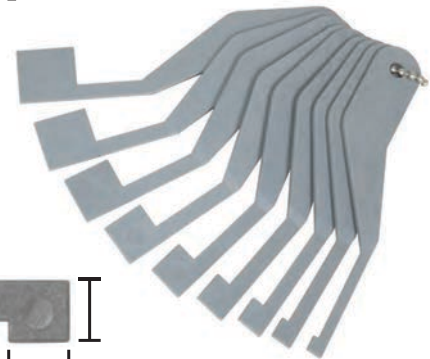

U.S. Pat No. 9,500,462

40750 PARKING BRAKE CABLE REMOVER

Allows Technician to Remove Parking Brake Cable by Compressing the Spring.

Tool can be used when cable is still attached to parking brake assembly. Ends of tool are angled to allow easier access. Slots on each end allow tool to slip over cable instead of feeding the cable through the end of the tool. Especially useful on Ford F-Series, Expeditions, Excursions, etc.

40750 Parking Brake Cable Remover. Skin-Packed. Shipping wt. 5 oz.

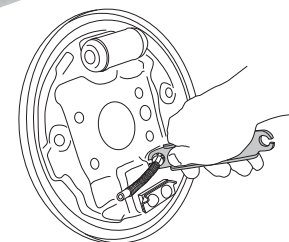
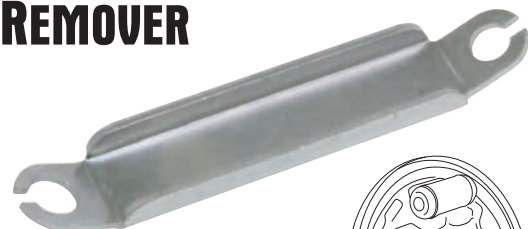

44210 UNIVERSAL EMERGENCY BRAKE TOOL

Allows Technicians to Compress the Emergency Brake Cable Spring with One Hand.

Keeps one hand free for brake shoe arm or lever replacement.

44210 Universal Emergency Brake Tool. Skin-Packed. Shipping wt. 6 oz.



44220 EMERGENCY BRAKE CABLE RELEASE TOOL

Quickly and Easily Pushes the Emergency Brake Cable Out of the Cable Connector for Rear Brake Service or Replacement.

The tool can be used on many domestic and import vehicles with an emergency brake cable at the rear wheels. Works on drum brake applications as well as vehicles with rear disc brakes.

44220 Emergency Brake Cable Release Tool. Skin-Packed. Shipping wt. 7 oz.



33260 BRAKE FLARING TOOL KIT

Low Profile Design Allows the Two Most Popular Tubing Sizes to be Flared in Tight Spaces.

Creates single or double flares on 3/16" / 4.75mm and 1/4" tubing. The vise assembly holds tubing centered securely without marring. Depth stop ensures proper tubing length. Holes in vise allow you to see the tubing is properly located. Internal deburring tool included to help make perfect flares.

33260 Double Flaring Tool 3/16" & 1/4". Molded Case. Shipping wt. 1 lb. 12 oz.

33280 Brake Line Vise, Top 33290 Brake Line Vise, Bottom

33300 Handle 33310 Flange Bolt, 2 pc.

33320 Depth Plug 33330 Forming Die 3/16 & 4.75mm

33340 Grease 33350 Internal Deburring Tool

33370 Case for the 33260 33390 Forming Die 1/4



YouTube



BRAKE

48020 BRAKE CALIPER HANGER SET, 2PC.

Hangs the Disc Brake Caliper Out of the Way During Service While Keeping Tension Off the Brake Line.

Helps prevent damage to calipers and lines when servicing brakes, suspension, hubs and more. Overall length of 9" for hanging the disc brake caliper out of the way while keeping tension off the brake line. Set of two hangers.

48020 Brake Caliper Hanger. Skin-Packed. Shipping wt. 7 oz.

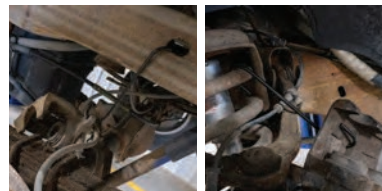

YouTube



13410 BRAKE CALIPER BRUSH

Cleans Brake Caliper Mounting Surfaces.

Removes brake dust, rust and other debris from brake caliper castings. Brush is made with heavy-duty steel wire and is angled to fit into tight places. Brush comes with molded handle grip for easy use.

13410 Brake Caliper Brush. Skin-Packed. Shipping wt. 3 oz.



14020 2-1/2" WIRE CUP BRUSH

Removes Weld Scale, Rust, Paint and Corrosion From Metal Surfaces.

Brush also gives an excellent surface for painting. Made with .014 carbon steel wire and designed for light duty use with an electric drill. Maximum safe free speed is 4500 RPMs.

14020 2 1/2" Wire Cup Brush. Skin-Packed. Shipping wt. 5 oz.

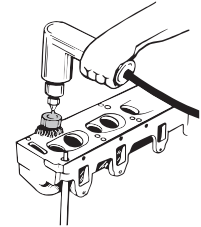

14040 1" WIRE END BRUSHES

For Light to Heavy Duty Work.

Made with .020" industrial heat tempered wire. Use with portable electric and air tools. 20,000 RPM maximum safe free speed. 14040 knot end brush for heavy duty use. Excellent for baked on gaskets. 14060 crimped end brush for light to heavy work. Cleans dirt and carbon from metal surfaces.

14040 1" Knot Wire End Brush. Skin-Packed. Shipping wt. 4 oz.

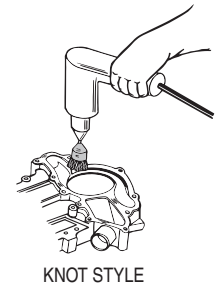

KNOT STYLE

14160 14180 SCRATCH BRUSHES

Removes Rust, Scale, Paint and Solder from Metal Surfaces.

Also great for cleaning threads and files. 14160 has 5-1/2" of densely packed wire bristles and a hardwood handle. Overall length is 14". 14180 has 4-1/2" of densely packed wire bristles and a hardwood handle. Overall length 9-3/4".

14160 Scratch Brush. Skin-Packed. Shipping wt. 7 oz.

14180 Shoe Handle Wire Scratch Brush. Skin-Packed. Shipping wt. 7 oz.

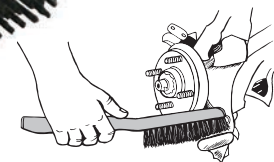

14000 PARTS CLEANING BRUSH

Removes Dirt and Grease From Motors, Machinery and Metal Parts.

Polypropylene bristles hold up under repeated use in cleaning solvents.

14000 Parts Cleaning Brush. Skin-Packed. Shipping wt. 5 oz.

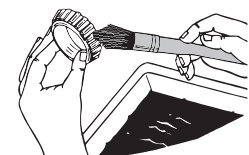

PARTS CLEANING BRUSHES – for use in cleaning all engines and engine parts (truck, auto, aircraft, marine, farm), transmissions, brakes, gear boxes and other metal parts.

- Stiff, long-lasting Trialoy® polyester bristle shaped for maximum cleaning efficiency.
- Durable, injection molded handle with ribbed design for firm grip.
- Designed to be used in either solvent-based or water-based cleaning solutions.
- Contact us for special bulk private label quotes. We can use tan or black handles and several ferrule colors along with custom printing on most brushes.

DETAILING BRUSHES – *SoftTip* brushes for detailing vehicles, boats, aircraft and more.

89500 89510 BUCKET BRUSHES

ATLASTA®, ATLASTA® SoftTip Parts Washer and Detail Brush

“Bucket brushes” are designed for hand use in a parts washing sink or solvent container. Cleaning is achieved by pressing the solvent-filled Trialoy® bristles against the dirty surface. A tough brush that will last and last. 89510 is similar to our popular Atlasta® parts cleaning brush but with softer filament that won't scratch chrome or polished metal. Both have innovative bullet-shaped tips that resist mushrooming. Durable injection molded handle with ribbed design for firm grip. Long-lasting, stiff Trialoy® polyester filament can be used in either solvent- or water-based cleaning solutions.

89500 ALASTA® Parts Brush. Skin-Packed. Shipping wt. 5 oz.

89510 ALASTA® SoftTip Brush. Skin-Packed. Shipping wt. 5 oz.



89520 89530 89540 89550 89680 FLOW-THRU BRUSHES

ORIFLO®, ORIFLO® SoftTip, MULTIJET® are Flow-Thru Brushes Designed for Parts Washing Sinks with Circulating Solvent Systems.

Designed for industrial parts washers with solvent circulating pumps. 89520, 89530, 89540 ORIFLO® flow-thru parts washer brushes deliver a continuous stream of solvent through the bristle. 89530 includes a 28" Buna N (nitrile rubber) tube. 89550 MULTIJET® employs an additional ring of solvent jets to wash debris from the cleaning head. 89680 STRAIGHT SHOOTER incorporates a push button flow control valve. Bullet-shaped tip resists mushrooming. Durable, injection-molded handle with ribbed design for firm grip. Long-lasting, stiff Trialoy® polyester filament can be used in either solvent- or water-based cleaning solutions. Buna N is resistant to solvent-based cleaning solutions.

89520 ORIFLO® Flow-Thru Brush. Skin-Packed. Shipping wt. 5 oz.

89530 ORIFLO® Flow-Thru Brush with Tube. Hang Card. Shipping wt. 8 oz.

89540 ORIFLO® SoftTip Brush. Skin-Packed. Shipping wt. 5 oz.

89550 Multijet® Flow-Thru Brush. Skin-Packed. Shipping wt. 5 oz.

89680 Straight Shooter #8 Flow-Thru Brush w/Valve. Mini Pouch. Shipping wt. 5 oz.



89550 Multijet®

**89640 89650 89660 89670
89690 ERGONOMIC BRUSHES**

For Each of Our Most Popular Parts Cleaning Brushes, We Have Developed an Ergonomic Equivalent.

The angled handle is designed to reduce strain in either a flowing solvent system or a solvent bath. Bullet-shaped tip resists mushrooming. Durable, injection-molded handle with ribbed design for firm grip. Long-lasting, stiff Trialoy® polyester filament can be used in either solvent- or water-based cleaning solutions. 89650 and 89690 incorporate the specially designed Multijet® ferrule with an additional ring of solvent jets to wash debris from the cleaning head.

- 89640 Brake Beauty #4 Flow-Thru Brush w/Valve. Mini Pouch. Shipping wt. 6 oz.
- 89650 Multi Flow #5 MJ Flow-Thru Brush w/Valve. Mini Pouch. Shipping wt. 5 oz.
- 89660 Work Horse #6 Flow-Thru Brush. Mini Pouch. Shipping wt. 5 oz.
- 89670 Bucket Buddy #7 Brush. Mini Pouch. Shipping wt. 5 oz.
- 89690 Right Angle #9 MJ Flow-Thru Brush w/Valve. Mini Pouch. Shipping wt. 4 oz.



89610 89620 89630 FLAT BRUSHES

TIME SAVER #1, #2, and #3. For Large Surface Cleaning Jobs, Our Innovative Flat Brush Design Makes Cleanup a Breeze.

TIME SAVER brushes are available in three separate models, each incorporating our strain-fighting ergonomic design. Durable, injection molded handle with ribbed design for firm grip. Long-lasting, stiff Trialoy® polyester filament can be used in either solvent- or water-based cleaning solutions.

- 89610 Time Saver #1 Flow-Thru Brush w/Valve. Mini Pouch. Shipping wt. 6 oz.
- 89620 Time Saver #2 Flow-Thru Brush. Mini Pouch. Shipping wt. 5 oz.
- 89630 Time Saver #3 Flat Brush. Mini Pouch. Shipping wt. 6 oz.



89560 89570 RUBBER TUBING

89560 28" and 89570 48" Buna N Tubing Connects to Solvent Circulating System and Works with Any Flow-Through Brush.

Buna N (nitrile rubber) tubing is resistant to solvent-based cleaning solutions. End of tube fits .50" - .60" nozzle on circulating solvent parts washers. O.D. 5/8". I.D. 1/4".

- 89560 Rubber Tube 28" for Flow-Thru Brush. Mini Pouch. Shipping wt. 4 oz.
- 89570 Rubber Tube 48" for Flow-Thru Brush. Mini Pouch. Shipping wt. 7 oz.



41500 PICKLE FORK KIT

For Separating Ball Joints, Tie Rods, Pitman Arms and Other Uses.

Six tools in one for exceptional versatility and value. Kit consists of three forks and two handles; one for hammering, the other for use with an air hammer (.401" shank). All forks are threaded to interchange with either handle. Forks are heavy-duty forgings.

41500 Pickle Fork Kit. Clam Shell. Shipping wt. 3 lbs. 15 oz.

41510 Handle	41520 Pneumatic Driver	41530 1-1/8" Fork
41540 15/16" Fork	41550 11/16" Fork	



41400 STEPPED PICKLE FORK KIT

Step Design Helps Keep Tool from Bouncing Back When Separating Ball Joints, Steering Dampeners, Tie Rods, Pitman Arms and Other Applications.

Six tools in one. Three forks and two handles. Forks are threaded to interchange with either handle. One handle for hammering; one for use with an air hammer (.401" shank). Forks are heavy-duty heat-treated, alloy steel forgings. Steps can be sharpened if needed.

41400 Stepped Pickle Fork Kit. Clam Shell. Shipping wt. 3 lbs. 13 oz.

41410 1-1/8" Stepped Fork	41420 11/16" Stepped Fork
41430 15/16" Stepped Fork	41510 Handle
41520 Pneumatic Driver	



41440 STEPPED PICKLE FORK KIT, 5 PC.

Step Design on the Forks Keeps the Tool from Bouncing Back when Separating Ball Joints, Steering Dampeners, Tie Rods, Pitman Arms and Other Applications.

Includes five forks: 11/16", 15/16", 1-1/8", 1-7/16" and 1-5/8". The forks are threaded to interchange with either the handle for hammering or the pneumatic driver. The forks are heavy-duty, heat-treated forgings and the handles are heat-treated alloy steel. The fork steps can be sharpened if needed.

41440 Step Pickle Fork Kit, 5pc. Molded Case. Shipping wt. 6 lbs. 8 oz.

41370 1-5/8" Stepped Fork	41380 1-7/16" Stepped Fork
41410 1-1/8" Stepped Fork	41420 11/16" Stepped Fork
41430 15/16" Stepped Fork	41510 Handle
41520 Pneumatic Driver	

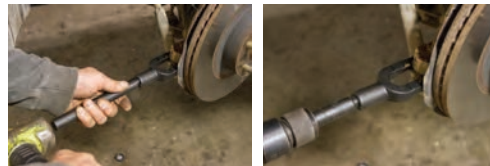

41220 THICK PICKLE FORK KIT, 5 PC.

The Thicker Fork Design Provides Extra Lift.

The set includes five forks: 11/16", 15/16", 1-1/8", 1-7/16" and 1-5/8". The forks are threaded to interchange with either the handle for hammering or the pneumatic driver (.401 Shank) and a 6-1/4" extension that works with either handle to provide extra reach.

41220 Thick Pickle Fork Kit. Molded Case. Shipping wt. 8 lbs.

41510 Handle	41520 Pneumatic Driver	41470 Long Extension
41200 1-5/8" Fork	41190 1-3/16" Fork	41180 1-1/8" Fork
41170 15/16" Fork	41160 11/16" Fork	



YouTube



SUSPENSION

18520 STEPPED TIE ROD SEPARATOR 18530 STEPPED BALL JOINT SEPARATOR

Step Design Helps Keep Tool from Bouncing Back.

18520 is used to replace worn out tie rods and to separate shock absorber links. The tine opening is 11/16". The 18530 is used to replace worn out ball joints and to remove CV drive shafts on FWD vehicles. The tine opening is 15/16". These heavy-duty tools are drop forged and heat-treated for long use. Steps can be sharpened if needed.

18520 Stepped Tie Rod Separator. Skin-Packed. Shipping wt. 1 lb. 11 oz.

18530 Stepped Ball Joint Separator. Skin-Packed. Shipping wt. 1 lb. 12 oz.

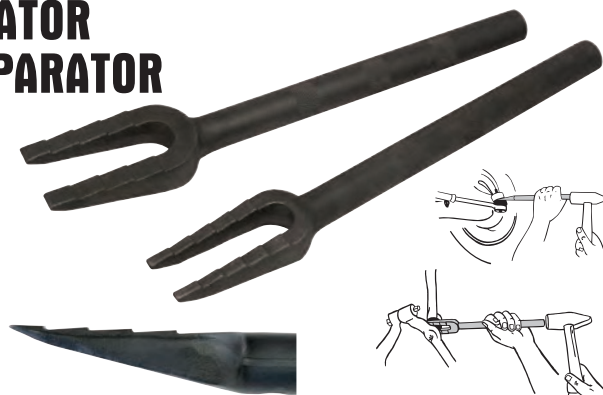

41900 PITMAN ARM PULLER

Heavy Duty Puller Works on Most Cars and Trucks.

Designed to work on even the most stubborn Pitman arm pulling jobs. Position puller jaws over Pitman arm and turn center screw to free Pitman arm. Puller body is drop-forged and heat-treated for strength.

41900 Pitman Arm Puller. Skin-Packed. Shipping wt. 2 lbs. 1 oz.

41910 Puller Screw

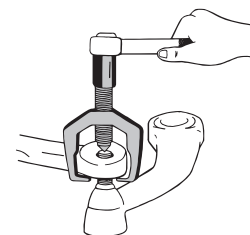

41970 HEAVY-DUTY PITMAN ARM PULLER

For 2005 and Later Ford F250 & F350.

A heavy-duty puller for the large Pitman arms on Ford 250 and 350 trucks. Jaws are forged and heat-treated for strength. Position puller jaws under the Pitman arm, turn center screw to remove.

41970 Heavy-Duty Pitman Arm Puller. Skin-Packed. Shipping wt. 3 lbs.

41910 Puller Screw

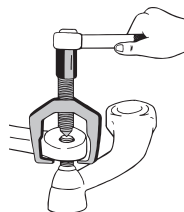

38210 HUB REMOVER KIT FOR DODGE

Separates the Frozen Hub Assembly from the Steering Knuckle on Dodge Vehicles.

Tool drives against loosened retaining bolts to separate assembly. Prevents damage to the knuckle and complete hub assembly. Tool drives on the bolt flange, so the head of the retaining bolt is not destroyed. Kit contains 39300 for older, smaller applications and 39250 for 2003 and newer 4-wheel drive 3/4 ton and 1 ton Dodge pickups. Available individually.

38210 Hub Remover Kit for Dodge. Skin-Packed. Shipping wt. 13 oz.

39250 Hub Remover 03-09 Dodge. Mini Pouched.

39300 Front Hub & Knuckle Separator. Skin-Packed.

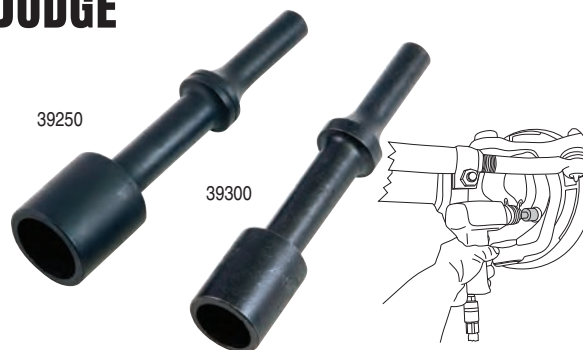

62300 STRUT TOOL

Safe - Universal - Inexpensive.

This is an inexpensive, but super safe strut spring compressor. Fits all strut spring sizes, import and domestic. Heavy duty clamps and bolts securely hold spring during operation.

62300 Strut Tool. Clam Shell. Shipping wt. 5 lbs. 13 oz.

62350 Bolt

62360 Nut

62370 Washer

62340 U-Bolt

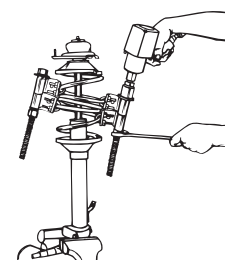

58100 INNER TIE ROD TOOL SET, 12 PC.

Improved Socket Design to Work on Longer Applications.

The long socket slips over tie rod end and crowfoot engages on socket for easy removal and installation of tie rods with inaccessible wrench flats. Includes 12 crowsfeet, sizes 1-3/16", 1-1/4", 1-3/8", 1-1/2", 1-5/16", 1-7/16", 29mm, 32.5mm, 33.6mm, 38.4mm, 40mm and 42mm, to fit many cars, trucks and SUVs.

58100 Inner Tie Rod Tool Set 12pc. Molded Case. Shipping wt. 7 lbs. 2 oz.

54490 40mm Crowfoot 54550 Retainer 54560 33.6mm Crowfoot

54570 1-7/16" Crowfoot 54580 38.4mm Crowfoot 54590 42mm Crowfoot

58101 1-3/16" Crowfoot 58020 1-1/4" Crowfoot 58030 1-5/16" Crowfoot

58050 1-3/8" Crowfoot 58070 1-1/2" Crowfoot 58080 29mm Crowfoot

58090 32.5mm Crowfoot 58110 Socket 58130 Case for 58100

Supersedes 46800 & 54500



45750 INNER TIE ROD TOOL

Includes an Additional 1-1/2" Crows Foot for Chevrolet Colorado and GMC Canyon.

Works on tie rods with inaccessible flats. The rounded socket ends prevent access to the wrench flats. This tool utilizes six crows feet to engage the wrench flats. Long socket slips over tie rod end and connects to the crows foot. The inner tie rod can be removed and installed without removing the rack.

45750 Inner Tie Rod Tool. Clam Shell. Shipping wt. 3 lbs. 6 oz.

45770 Socket 45810 Retainer

45670 33.6mm Crowfoot 45700 1-3/16" Crowfoot

45820 1-7/16" Crowfoot 45830 1-5/16" Crowfoot

45840 1-1/4" Crowfoot 46160 1-1/2" Crowfoot



41630 21MM/24MM CASTER CAMBER KIT FOR GM

The 14-1/2" 21mm/24mm Wrench can be Used to Move Hard-to-Reach and Often Rusty OEM Cams on 1999 and Newer GM 1/2 and 3/4 Ton Vehicles with Coil Spring Front Suspensions.

The kit includes a cam adjusting holding tool to adjust the upper control arm cams found on Chevrolet and GMC vehicles. The holding tool surrounds the entire perimeter of each cam to provide a no-slip work area when moving the hard-to-reach and often rusty OEM cams. The 14-1/2" 21mm/24mm wrench can be conveniently used from the bottom side of the vehicle instead of reaching through the wheel well which saves technicians time.

41630 Caster Camber Kit for GM, 21mm & 24mm. Skin-Packed. Shipping wt. 1 lb. 2 oz.

41640 Caster Camber Wrench, 21mm & 24mm

41650 Caster Camber Holding Tool

Supersedes 41340



56750 SEAL PULLER

For Oil and Grease Seals.

Simply insert the tip of the tool behind the oil or grease seal, press and pull. Leverage works for you. Two size tips reach in and fit nearly all seal applications.

56750 Seal Puller. Skin-Packed. Shipping wt. 15 oz.



56650 ADJUSTABLE SEAL PULLER

Head Adjusts to 5 Positions.

Two hook sizes easily remove most oil and grease seals. Where clearance is a problem, remove the pin to reposition the head. The adjustable head works great on front wheel drive transaxles. Also works on front crankshaft seals without removing the radiator.

56650 Adjustable Seal Puller. Skin-Packed. Shipping wt. 15 oz.



U.S. Pat No. 7,039,993

56920 LIMITED ACCESS SEAL PULLER

Use With 3/8" Drive for Hard-to-reach Oil and Grease Seals.

Simply insert hook behind seal and pull. Two hook sizes to fit most oil and grease seals. Can also be used with a breaker bar for extra reach or leverage. If the puller tips wear, resharpen on a grinding wheel.

56920 Limited Access Seal Puller. Skin-Packed. Shipping wt. 3 oz.



34550 HANDY PACKER® BEARING PACKER

Quickly Flushes Out Old Grease and Repacks Bearings with Less Mess.

The Handy Packer works on bearings up to 3-1/2" O.D. The grease stays in the tool cavity, not on your hands. To pack a bearing, place the bearing on the piston. Press down on the cap until the old grease is forced out and the new grease shows on top of the bearing.

34550 Handy Packer Bearing Packer. Clam Shell. Shipping wt. 1 lb. 4 oz.



65250 UNIVERSAL BEARING PACKER

Fast, Efficient, Thorough.

Simply place the bearing between the plastic cones, tighten, and apply grease through the fitting on the end of the threaded shaft. Forces out old grease and evenly injects fresh grease. Cone diameter is 4-1/2".

65250 Universal Bearing Packer. Skin-Packed. Shipping wt. 7 oz.

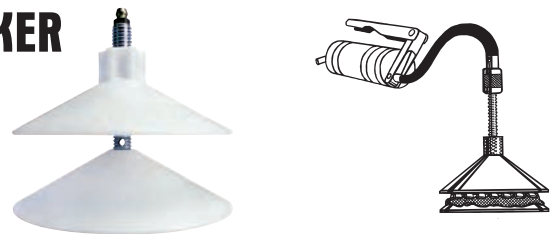

20400 SHOCK ABSORBER TOOL

For Removing and Installing Shock Nuts.

Fits most domestic models and some Ford OEM shock nuts. Place stem socket over shock stem. Hex nut socket fits the nut. Hold one, turn the other for removal.

20400 Universal Shock Absorber Tool. Skin-Packed. Shipping wt. 9 oz.



12800 MASTER PNEUMATIC BEARING RACE & SEAL DRIVER SET

This Master Set Contains 11 Drivers to Fit Automobiles and Trucks up to 1 Ton.

This set also includes 2 handles, one for hammering and a pneumatic handle for use with an air hammer. Use the tapered driver side for bearing races; reverse to the flat side for seals. To add the pneumatic handle to your current set order a 12820 pneumatic driver. Molded case.

12800 Master Pneumatic Bearing Race & Seal Driver Set. Molded Case. Shipping wt. 6 lbs. 11 oz.

12820 Pneumatic Handle 12730 Handle

*FOR HEAVY-DUTY APPLICATIONS SEE 61900, Pg. 121



Driver No.	Size
12610	1.565
12620	1.750
12630	1.965
12640	2.325
12650	2.555
12690	2.830
12700	2.995
12710	2.470
12810	4.625
12930	3.813
12970	3.180

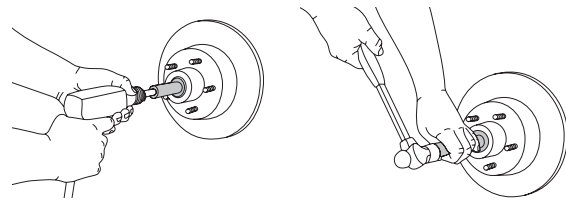

U.S. Pat No. 7,707,709

SUSPENSION

12600 12980 BEARING RACE AND SEAL DRIVER SETS

Makes it Easier to Insert Bearing Race.

Insert bearing race quickly, straight in on FIRST TRY! Helps reduce damage to both race and axle housing. Turn driver over to drive seals.

12600 Bearing Race Driver. Includes 6 drivers. Clam Shell. Wt. 1 lb. 9 oz.

12980 Bearing Race and Seal Driver. Includes 9 drivers. Molded Case. Wt. 3 lb.

12660 Handle

MEASUREMENTS ARE TO OUTSIDE OF DRIVERS.

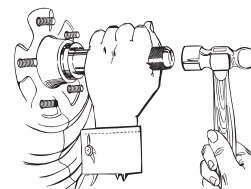

Driver No.	Size
12610	1.565"
12620	1.750"
12630	1.965"
12640	2.325"
12710	2.470"
12650	2.555"
12690	2.830"
12700	2.995"
12970	3.180"

*There are 9 Drivers. The first 6 are included in the 12600. The largest 3 are available individually or in the 12980 Master Set.

24800 SEAL DRIVER KIT

Quickly Drives Seals Without Damage.

Sixteen adapters for seals up to 3-3/8" diameter. Includes special adapters for "shielded" seals.

24800 Seal Driver. Clam Shell. Shipping wt. 1 lb. 11 oz.

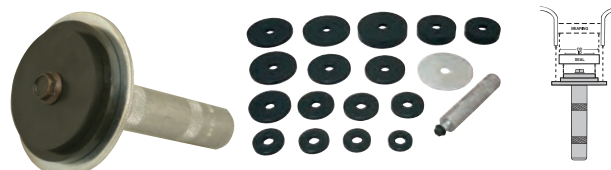

SET INCLUDES 16 ADAPTERS, ONE WASHER AND ONE HANDLE

59400 PINION BEARING RACE DRIVER SET

Set Includes 8 Drivers for Driving Inner and Outer Pinion Bearing Races on 1/2 & 3/4 Ton Ford, Dodge and GM Pickups.

Use the extended, two-piece handle for driving rear pinion bearing races. A pneumatic handle is also included for use with an air hammer.

59400 Pinion Bearing Race Driver Set. Molded Case. Shipping wt. 7 lbs. 6 oz.

12820 Pneumatic Handle

59540 Handle

59530 Handle Extension (with Tapped Hole)



Driver No.	Size
59410	2-11/16"
59420	2-27/32"
59430	2-7/8"
59440	3"
59450	3-1/4"
59460	3-1/2"
59470	3-3/4"
59480	4-1/8"
12970	3.180"

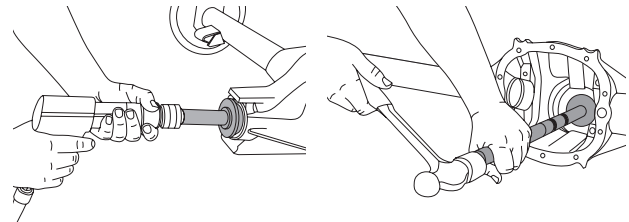

U.S. Pat No. 7,707,709

SUSPENSION

43300 PNEUMATIC FAN CLUTCH WRENCH SET

Updated Driving Wrench Assortment in Case.

Quickly removes and installs fan clutch when repairing the water pump or fan clutch. Faster and easier than conventional fan clutch wrenches. No holding wrench is necessary. Set includes 7 driving wrenches that fit Ford, GM, Chrysler & Jeep. Set now includes 7/8", 32mm, 36mm, 40mm thin and new 47mm size to fit Ford 6.0L and 6.4L Powerstroke diesel pickup. 1-7/8" and 2" are still included in the set. 1-1/2", 41mm and 42mm are still available individually. Use with an air hammer.

43300 Pneumatic Fan Clutch Wrench Set. Molded Case. Shipping wt. 9 lbs. 5 oz.

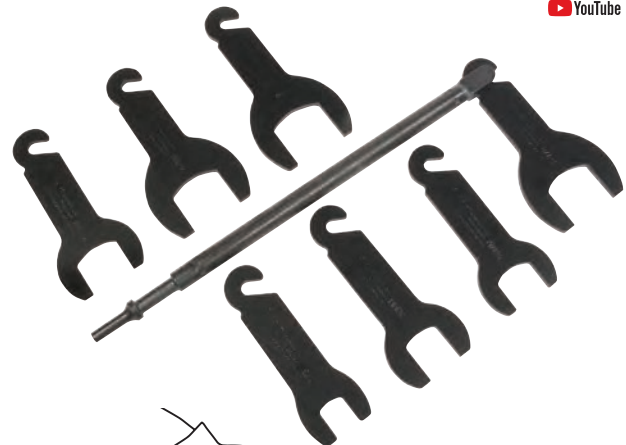

YouTube

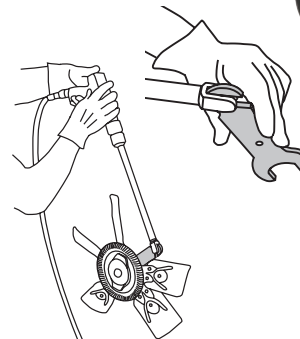

Part #	Description
43370	Handle Assembly
43380	32mm Driving Wrench
43390	36mm Driving Wrench
43410	1-7/8" Driving Wrench
43420	2" Driving Wrench
43430	7/8" Driving Wrench
43440	40mm Driving Wrench
43530	47mm Driving Wrench

U.S. Pat No. 6,354,178

FAN CLUTCH

43340 2-1/8" FAN CLUTCH WRENCH

Use with the 43300 Pneumatic Fan Clutch Wrench Set.

Quickly removes and installs the fan clutch when repairing or replacing the water pump or fan clutch. Works without a holding wrench. Use with an air hammer and the 43370 Driving Wrench from the 43300 Pneumatic Fan Clutch Wrench Set to remove and install the fan clutch when repairing or replacing the water pump or fan clutch. The 2-1/8" Fan Clutch Wrench fits the Borg Warner fan clutch found on International Navistar trucks with 13L and 15L Maxforce engines. May fit other 2-1/8" applications.

43340 2-1/8" Fan Clutch Wrench. Mini Pouch. Shipping wt. 14 oz.



43600 UNIVERSAL FAN CLUTCH WRENCH SET

Three Piece Set Includes a Double-Ended Turning Wrench and Two Holding Wrenches to Fit Most All Applications.

The two pin spanner wrench configurations work on GM, Jeep and Dodge trucks, vans and SUVs with pressed-on water pump pulleys. The double-sided spanner wrench fits two holes in pressed-on water pump pulleys. The universal holding wrench works on all sizes of bolt-on water pump pulleys.

43600 Universal Fan Clutch Wrench Set. Clam Shell. Shipping wt. 2 lbs. 13 oz.

43560 36mm - 47mm Fan Clutch Wrench

43890 Universal Holding Wrench

43580 GM/Dodge Holding Wrench. Hang Tag. Shipping wt. 14 oz.



U.S. Pat No. 9,662,794

44180 FAN CLUTCH SPANNER WRENCH

For GM, Jeep and Dodge Trucks, Vans and SUVs With Pressed on Water Pump Pulleys.

The double-ended spanner wrench fits the holes in pressed-on water pump pulleys. Hold the pulley firm with the spanner wrench. Use the appropriate open end wrench to turn the fan clutch nut (41740 36mm turning wrench works on many applications).

44180 Fan Clutch Spanner Wrench. Skin-Packed. Shipping wt. 2 lbs. 5 oz.

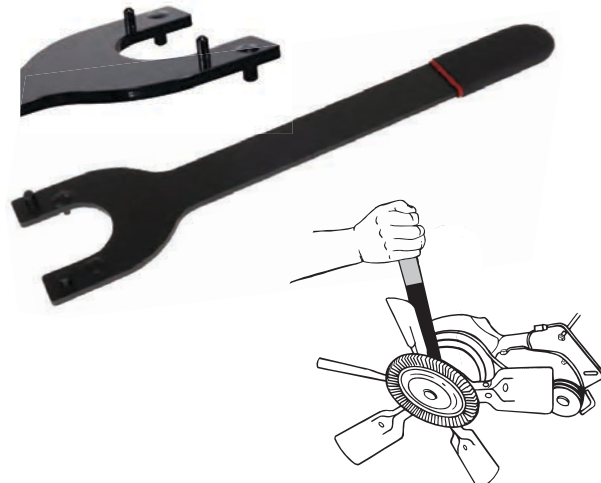

38350 EXHAUST REMOVAL PLIERS

Separates Exhaust Hanger Brackets From Rubber Supports.

The exhaust pliers work on all import and domestic car and truck exhaust systems that use the rubber hanger supports. Simply squeeze the handles to push the bracket from the rubber support.

38350 Exhaust Removal Pliers. Skin-Packed. Shipping weight 1 lb. 3 oz.



17350 PIPE STRETCHER KIT 34400 PIPE STRETCHER

Stretches All Pipe Including Stainless Steel.

Use with an impact wrench to quickly stretch pipes. Collet sets expand pipes from 1-5/8" to 4-1/4". The tool can be used on the vehicle. The pipe stretcher is a convenient, inexpensive alternative to hydraulic pipe expanders. The kit comes in a molded case for storage.

17350 Pipe Stretcher Kit. Molded Case. Shipping wt. 9 lb. 14 oz.

17510 Extender #1	17520 Extender #2
17530 Extender #3	17540 Extender #4
17550 Extender #5 (must be used with 17530)	17710 O Ring #1
17720 O Ring #2	17730 O Ring #3
17740 O Ring #4	17750 O Ring #5

34400 Pipe Stretcher. Clam Shell. Shipping wt. 4 lb. 10 oz

34490 Large O Ring 34500 Small O Ring



YouTube



34400 PIPE STRETCHER
(AVAILABLE INDIVIDUALLY IN A CLAM SHELL PACKAGE.)

17060 5" ADAPTER FOR TAILPIPE STRETCHER

Collet Expand Pipes Up to 5" Including Stainless Steel.

The tool must be used with the 17350 Tail pipe stretcher kit. The tool can be used on the vehicle. The pipe stretcher kit is a convenient, inexpensive alternative to hydraulic pipe expanders. Choose appropriate aluminum adapter to use with the standard expander tool. The 3-1/2" adapter must be used with the 5" adapter. Be sure to keep threads and cone well lubricated.

17060 5" Adapter for Pipe Stretcher. Pouch. Shipping wt. 1 lb. 10 oz.

17070 O-Ring for 5" Adapter, 1pc.



32500 32750 TAILPIPE EXPANDERS

Removes Clamp Grooves and Rounds Out Pipes.

Practical, rugged tools that make easy work of a tough job. Two sizes fit most pipes: 32500 - 1-5/8" to 2-7/16" (41.3mm - 61.9mm) and the 32750 - 2-3/8" to 3-1/4" (60.3mm - 82.5mm).

32500 Tailpipe Expander 1-5/8" to 2-7/16" . Clam Shell. Shipping wt. 2 lbs. 13 oz.

32750 Tailpipe Expander 2-3/8" to 3-1/4" Boxed. Shipping wt. 4 lbs. 2 oz.



	For	For
Threaded Cone	32610	32780
Plain Cone	32620	32770
Cone Spacer	32630	32790
"O" Ring Kit	32030	32740



32000 PIPE END SHAPER

Rounds Pipes In or Out.

Rounds out exhaust pipes that are crushed or bent. Also reshapes pipes bent or flared out by placing big end over pipe. Range is 1-1/2" - 3-5/8" (38.1 - 92mm).

32000 Pipe End Shaper. Boxed. Shipping wt. 4 lbs. 15 oz.

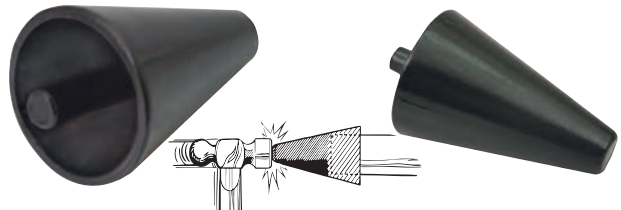

39550 FWD AXLE NUT SOCKET 6 PT.

For All 36mm Axle Nuts.

Durable, impact-grade material. Deep to fit over variable axle lengths. Works where standard sockets won't. Use 1/2" drive.

39550 FWD Axle Nut Socket (36mm), Hang Tag. Shipping wt. 1 lb. 13 oz.

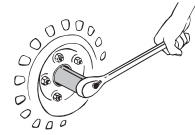

39650 39MM 12 PT. AXLE NUT SOCKET FOR TOYOTA

Removes and Installs Axle Nuts on 4-Wheel Drive Axle Hubs.

Made of durable, impact-grade heat-treated alloy steel. Extra deep design fits over various axle lengths. Works where standard sockets won't. Use with 1/2" drive.

39650 39mm 12pt Axle Nut Socket for Toyota. Hang Tag. Shipping wt. 1 lb. 4 oz.



Applications: Toyota Land Cruiser 2008-2010, Toyota Sequoia 2008-2010, Toyota Tundra 2007-2010, Lexus LX 570 2008.



39510 30MM 12 PT. AXLE NUT SOCKET

Removes and Installs Axle Nuts and Automatic Transmission Tail Output Shafts.

Heat-treated alloy steel, impact quality, extra deep, 1/2" drive.

39510 30mm 12pt Axle Nut Socket. Hang Tag. Shipping wt. 1 lb. 4 oz.

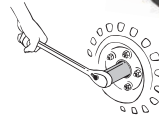

Applications: Chrysler- 300C, Crossfire 2004, Dodge-Freightliner Sprinter vans with 215mm rear axle 2004 and up, Magnum 2004, Jeep- Grand Cherokee V6 models 2005, Lexus- ES300, Pontiac- Vibe, Mercedes- many models, Toyota- Avalon, Camry, Highlander, Matrix, VW- Beetle, Jetta, Golf 1999 and up.

22090 36MM 12 PT. AXLE NUT SOCKET

Durable Impact-Grade Material Sockets for Removing and Installing Axle Nuts.

Fits some European vehicle applications and uses 3/4" drive.

22090 36mm 12 pt. Axle Nut Socket. Mini Pouch. Shipping wt. 15 oz.



31550 AXLE HUB BRIDGE NUT SOCKET FOR GM

Removes and Installs the Hub Bearing Retaining Nut Found on Some GM GMT900 Platform Full-Size Trucks.

The socket has nine drive pins to fit the new style retaining nut found on 2-wheel and 4-wheel drive Cheyenne, Silverado, Escalade, Sierra and Avalanche trucks with 10.5" or 11.5" ring gear. Made from alloy steel. Use with 1/2" drive.

31550 Axle Bridge Nut Socket GM. Box. Shipping wt. 2 lbs. 8 oz.



30800 CV BOOT CLAMP PLIERS

For Ear-Type Clamps.

For all ear-type clamps including GM FWD outboard CV joints. Designed for use with a torque wrench, as required for stainless steel bands.

30800 CV Boot Clamp Pliers (Ear-Type). Skin-Packed. Shipping wt. 1 lb. 3 oz.



30600 OFFSET BOOT CLAMP PLIERS

Crimps Ear-Type Clamps in Hard-to-Reach Areas.

A special boot clamp crimping pliers that is designed to work in confined spaces. The pliers work from the side (head is turned 90 degrees) unlike traditional tools that work from the end. The unique offset design allows the technician to work on clamps on larger size boots. The top plate on the pliers flattens the crimp. These pliers work on most ear-type clamps except those requiring a torque reading.

30600 Offset Boot Clamp Pliers. Skin-Packed. Shipping wt. 12 oz.



30500 CV BOOT CLAMP PLIERS

For Earless-Type Clamps.

A sturdy, low-cost tool. Works on earless-type clamps including those found on GM inboard CV joints.

30500 CV Boot Clamp Pliers (Earless-Type). Skin-Packed. Shipping wt. 13 oz.



30950 CV JOINT BANDING TOOL

For All Band-It® and Band-It Jr.® Style Clamps.

Works on all CV joints using the Band-It or Band-It Jr. type boot bands. Use 5/8" socket or wrench to wind and crimp new band on boot. Tool is easily disengaged from the band after the band is tightened.

30950 CV Joint Banding Tool. Skin-Packed. Shipping wt. 7 oz.



Band-It and Band-It Jr. are trademarks of Band-It-IDEX, Inc.

27400 4-WD WHEEL BEARING LOCK-NUT TOOLS

Combination tool for both 4-slot and 6-slot applications. 1/2" drive. Not for use with impact wrench.

27400 Combination 4-WD Wheel Bearing Lock-Nut Tool. Hang Tag. Shipping wt. 1 lb. 7 oz.

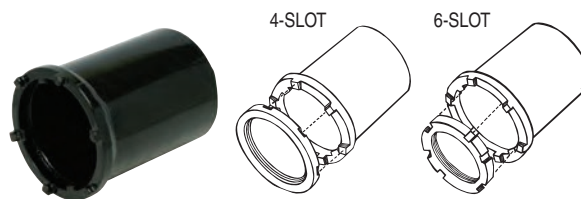

28000 RATCHETING LOCK NUT TOOL

Double-Ended for Both Sizes of Ratcheting Style Lock Nuts.

Two tools in one! Small end fits Ford 1986 to 1994 light trucks with Dana 44 front axle. Large end fits 1985 & newer Ford F150 - F350 trucks with the Dana 80 full floating rear axle. Press tool into lock nut and rotate to release the ratchet inside the lock nut. A torque wrench is used when installing. Use with 1/2" square drive.

28000 Ratcheting Lock Nut Tool. Clam Shell. Shipping wt. 2 lbs. 10 oz.

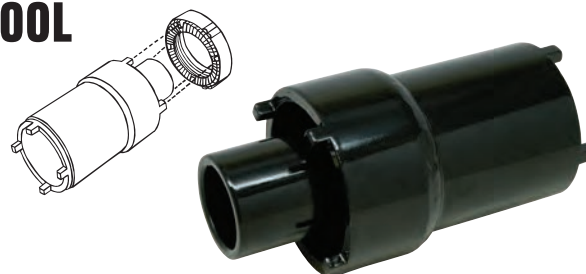

MANIFOLD DRILL TEMPLATES

Removes Broken Exhaust Manifold Bolts Without Damaging the Head.

Tapered bolts center base plate over bolt holes and slip fit bushing allows you to move from hole to hole without moving base plate. Drill depth gauge to make sure water jacket is not pierced. The screw extractor is then used to remove the broken bolt. Includes bushing to drill to tap size when extractor cannot be used. All templates come with a blow molded case for storage.



72400 MANIFOLD DRILL TEMPLATE FOR DURAMAX 6.6L DIESEL



72400 Drill Kit GM 6.6L. Molded Case. Shipping wt. 4 lb. 1 oz.	
68690 Stud Extractor	71530 3/16" Cobalt Drill
71540 17/64" Cobalt Drill	72310 .332 Q Cobalt Drill
72320 3/16" Drill Bushing, Large	72330 17/64" Drill Bushing, Large
72340 .322 Q Drill Bushing, Large	72360 Lock Screw
72370 10mm Tap Guide	72410 Alignment Bolt
72420 Case for 72350/72400	72430 GM 6.6L Drill Plate
72440 GM 6.6L Drill Depth Gauge	



ENGINE

72600 MANIFOLD DRILL TEMPLATE FOR DODGE 4.7L



72600 Manifold Drill Template for Dodge 4.7L. Molded Case. Shipping wt. 4 lb.	
68690 Stud Extractor	71520 1/8" Cobalt Drill
71410 Alignment Bolt	71530 3/16" Cobalt Drill
71420 8mm Tap Aligner	71540 17/64" Cobalt Drill
71450 Lock Screw	72570 4.7L Drill Depth Gauge
71460 1/8" Slip/Fix Bushing	72580 4.7L Dodge Plate
71470 3/16" Slip/Fix Bushing	72590 Case for 7260
71480 17/64" Slip/Fix Bushing	

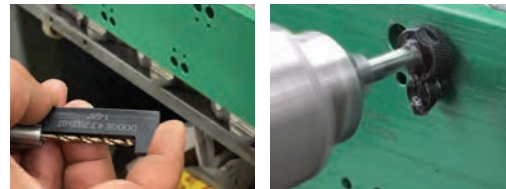
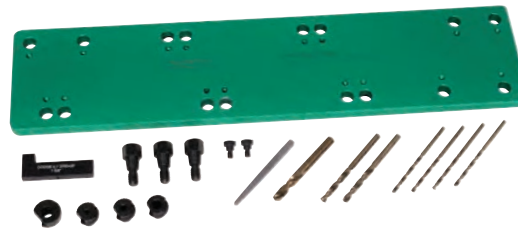

71500 MANIFOLD DRILL TEMPLATE FOR DODGE 5.7L HEMI



71500 Manifold Drill Template for Dodge 5.7L Hemi. Molded Case. Shipping wt. 4 lb. 3 oz.	
68690 Stud Extractor	71490 Dodge 5.7 Drill Plate
71390 Drill Depth Gauge	71410 Alignment Bolt
71420 8mm Tap Aligner	71450 Lock Screw
71460 1/8" Slip/Fix Bushing	71470 3/16" Slip/Fix Bushing
71480 17/64" Slip/Fix Bushing	71520 1/8" Cobalt Drill
71530 3/16" Cobalt Drill	71540 17/64" Cobalt Drill
71550 Case for the 71500	

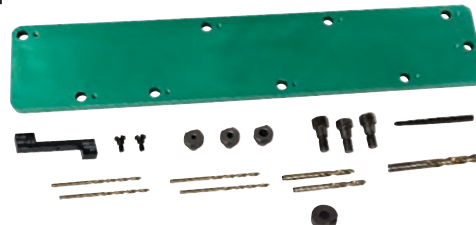

71400 MANIFOLD DRILL TEMPLATE FOR GM 4.8L, 5.3L & 6.0L

YouTube

71400 Manifold Drill Template for GM 4.8L, 5.3L & 6.0L. Molded Case. Shipping wt. 3 lb.

68690 Stud Extractor	71380 GM Drill Plate LS III
71390 Drill Depth Gauge	71410 Alignment Bolt
71420 8mm Tap Aligner	71450 Lock Screw
71460 1/8" Slip/Fix Bushing	71470 3/16" Slip/Fix Bushing
71480 17/64" Slip/Fix Bushing	71520 1/8" Cobalt Drill
71530 3/16" Cobalt Drill	71540 17/64" Cobalt Drill
71550 Case for the 71400	

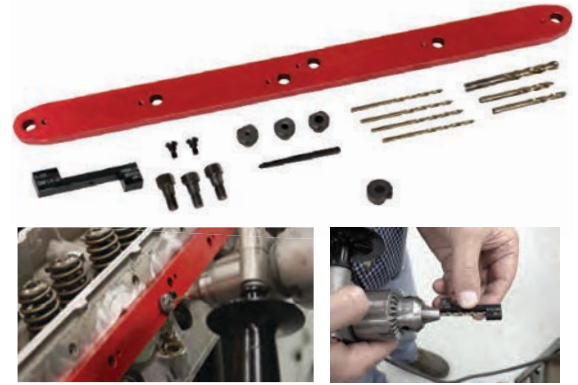

71650 MANIFOLD DRILL TEMPLATE FOR GM ECOTEC3 5.3L & 6.2L

YouTube

71650 Manifold Drill Template for GM EcoTec3 5.3L & 6.2L. Molded Case. Shipping wt. 3 lb.

68690 Stud Extractor	71640 GM 5.3L & 6.2L Drill Plate
71660 GM 5.3L & 6.2L Drill Depth Gauge	71410 Alignment Bolt
71420 8mm Tap Aligner	71450 Lock Screw
71460 1/8" Slip/Fix Bushing	71470 3/16" Slip/Fix Bushing
71480 17/64" Slip/Fix Bushing	71520 1/8" Cobalt Drill
71530 3/16" Cobalt Drill	71540 17/64" Cobalt Drill
71550 Case for the 71400 / 71500	71620 Alignment Nut, 1pc



71600 MANIFOLD DRILL TEMPLATE FOR FORD 4.6L, 5.4L & 6.8L

YouTube

71600 Manifold Drill Template for Ford 4.6L, 5.4L & 6.8L. Molded Case. Shipping wt. 4 lb. 3 oz.

68690 Stud Extractor	71590 Ford Gas Drill Plate
71610 Ford 4.6 Drill Depth Gauge	71410 Alignment Bolt
71420 8mm Tap Aligner	71450 Lock Screw
71460 1/8" Slip/Fix Bushing	71470 3/16" Slip/Fix Bushing
71480 17/64" Slip/Fix Bushing	71520 1/8" Cobalt Drill
71530 3/16" Cobalt Drill	71540 17/64" Cobalt Drill
71630 Case for the 71600	71620 Alignment Nut, 1pc



72450 MANIFOLD DRILL TEMPLATE FOR FORD 6.2L

YouTube

72450 Drill Kit Ford 6.2L. Molded Case. Shipping wt. 4 lb. 12 oz.

68690 Stud Extractor	71530 3/16" Cobalt Drill
71540 17/64" Cobalt Drill	72310 .332 Q Cobalt Drill
72320 3/16" Drill Bushing, Large	72330 17/64" Drill Bushing, Large
72340 .322 Q Drill Bushing, Large	72360 Lock Screw
72370 10mm Tap Guide	72460 Drill Plate for Ford 6.2L
72470 Drill Depth Gauge for Ford 6.2L	72480 Alignment Bolt 10mm x 1.25, 1 pc.
72490 Alignment Nut 10mm x 1.25, 1 pc.	72510 Case for 72450



71350 MANIFOLD DRILL TEMPLATE FOR FORD 6.0L & 6.4L DIESEL

71350 Manifold Drill Template for Ford 6.0L & 6.4L Diesel. Molded Case. Shipping wt. 4 lb. 3 oz.

68690 Stud Extractor	71580 Ford Drill Template 6.0L & 6.4L
71570 Drill Depth Gauge	71410 Alignment Bolt
71420 8mm Tap Aligner	71450 Lock Screw
71460 1/8" Slip/Fix Bushing	71470 3/16" Slip/Fix Bushing
71480 17/64" Slip/Fix Bushing	71520 1/8" Cobalt Drill
71530 3/16" Cobalt Drill	71540 17/64" Cobalt Drill
71550 Case for the 71350 / 71400 / 71500	

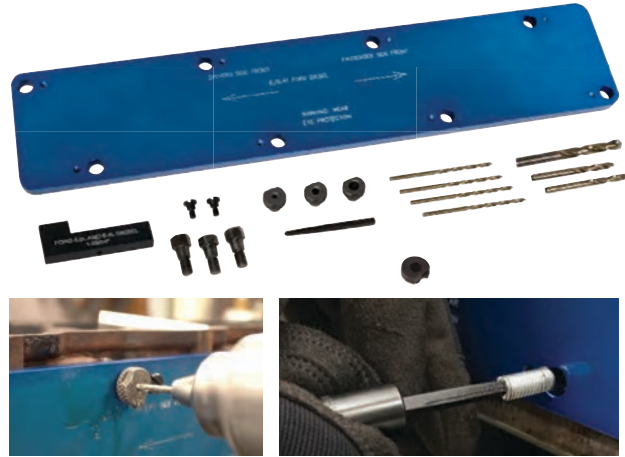

72350 MANIFOLD DRILL TEMPLATE FOR FORD 7.3L DIESEL

72350 Drill Kit Ford 7.3L. Molded Case. Shipping wt. 2 lb. 15 oz.

68690 Stud Extractor	71530 3/16" Cobalt Drill
71540 17/64" Cobalt Drill	72310 .332 Q Cobalt Drill
72320 3/16" Drill Bushing, Large	72330 17/64" Drill Bushing, Large
72340 .322 Q Drill Bushing, Large	72360 Lock Screw
72370 10mm Tap Guide	72380 Ford 7.3L Drill Plate
72390 Ford 7.3L Drill Depth Gauge	72410 Alignment Bolt
72420 Case for 72350/72400	

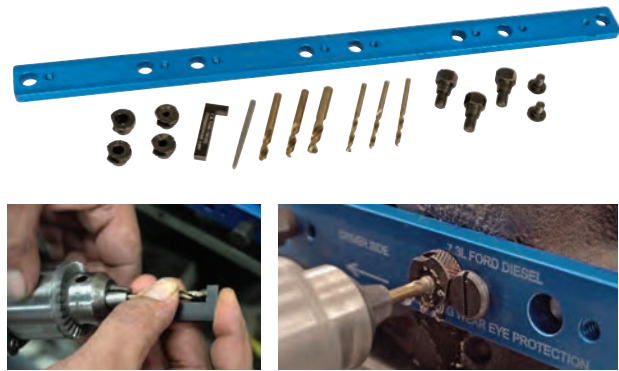

68500 MANIFOLD DRILL TEMPLATE FOR FORD 2V & 3V

Designed to Remove Broken Exhaust Manifold Studs on 4.6L, 5.4L 2 Valve, 5.4L 3 Valve and 6.8L V10 Ford Engines without Damage.

Interchangeable plates ensure drill is centered on the broken stud. Depth gauge for drilling is centered on the broken stud. The stripped screw extractor is then used to remove the broken stud.

68500 Manifold Drill Template for Ford. Molded Case. Shipping wt. 1 lb. 6 oz.

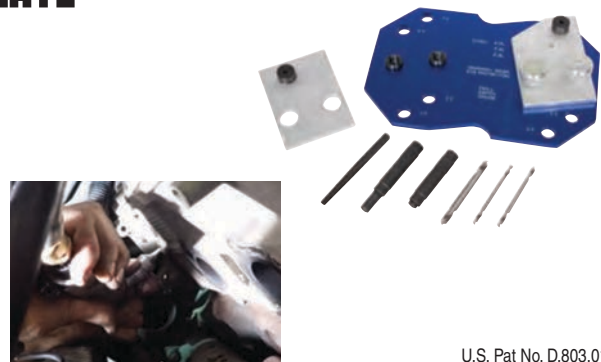

U.S. Pat No. D,803,019

36500 RIDGE REAMER

Big Range Scraper Action.

Rollers assure easy turning in cylinder. Exclusive stabilizer spring allows operator to take selective cut to minimize chatter. Spring-loaded carbide cutter follows contour of cylinder. Complete ridge removed in just a few easy turns. Offset jaw guides assure rigidity throughout the range.

36500 Ridge Reamer. Range 2-11/16" - 5-5/16" (68.3 - 134.9mm)
Clam Shell. Shipping wt. 2 lbs. 3 oz. NSN 5110-00-228-7009

36510 Carbide Cutter



36660 CUTTER JAW ASS'Y INCLUDES: CUTTER JAW CASTING WITH STABILIZER SPRING AND (2) PRESSURE SPRINGS

36580 EXPANSION BAND

36510 CARBIDE CUTTER

33500 PISTON RING INSTALLER

Save by Reducing Ring Breakage.

Tapered jaws to remove and install most passenger car and light truck rings from 3/64" to 1/4" (1.2 - 6.3mm).

33500 Piston Ring Installer. Skin-Packed. Shipping wt. 4 oz.
NSN 5120-00-857-3190



21700 WRINKLE BAND RING COMPRESSOR

4 Ways Better!

1. LOW FRICTION! Wrinkle Band cuts friction in half. Rings slide in easily. 2. WRINKLE BAND! Can't slip down into cylinder. 3. CAM OPERATED! Set adjustment screw just once for entire set of pistons. 4. FASTER! Insert a full set of pistons in half the time, with half the work!

21700 Wrinkle Band Ring Compressor. Skin-Packed. Shipping wt. 6 oz.



RINGS SLIDE IN EASILY
RANGE 3" TO 5"
(76.2-127mm)

18500 19500 20500 21000 21500 RING COMPRESSORS

Lisle Spring Clutch Eliminates Ratchet Problems.

The Lisle spring clutch assures a proper fit on the piston and a positive locking action.

18500 Small Engine Ring Compressor. Range 1-1/2" to 3" (38.1-76.2mm)
Box. Shipping wt. 5 oz. NSN 5120-00-322-6223

19500 Ring Compressor. Range 2-1/8" to 5". (Height 3-1/2") Skin-Packed.
Shipping wt. 12 oz. NSN 5120-00-250-6055

20500 Ring Compressor. Range 3-1/2" to 7". (Height 3-1/2") Skin-Packed.
Shipping wt. 14 oz. NSN 5120-00-223-8848

21000 Ring Compressor. Range 3-1/2" to 7". (Height 7") Box.
Shipping wt. 1 lb. 11 oz. NSN 5120-00-116-7676

21500 Ring Compressor. Range 7" to 10". (Height 7") Box. Ship. wt. 2 lbs. 4 oz.



ENGINE

19000 TAKE-APART RING COMPRESSOR

Combines Lisle Spring Clutch with Take-Apart Feature

Necessary for Volkswagens, motorcycles, outboard motors, etc. Quick release makes it easy to remove from connecting rod. Can be used on conventional engines with narrow ring spacing.

19000 Ring Compressor. Range 2-1/8" to 5". (54-127mm) Box. Shipping wt. 6 oz.



24000 RING GROOVE CLEANER

Comes with Two Easy-To-Set Cutter Wheels.

Heavy coil spring holds cutter in groove for fast removal of carbon. Tool comes with standard 24020 cutter blade sizes: 5/64", 3/32", 1/8", 5/32", 3/16" and special 24350 cutter blade with sizes: 1.5mm, 1/16", 1.75mm, 2mm, and 1/4". Handles pistons 2-3/4" to 5" diameter.

24000 Ring Groove Cleaner. Skin-Packed. Shipping wt. 11 oz.

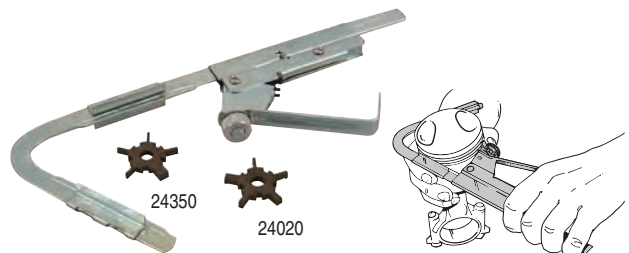

16750 VALVE SPRING COMPRESSOR

An "ON THE CAR" Tool.

Makes compressing the spring and removing the keepers a simple job. No need to remove the head. Adjustable cam action. No need to readjust the tool after each spring.

16750 Valve Spring Compressor. Clam Shell. Shipping wt. 1 lb. 15 oz.

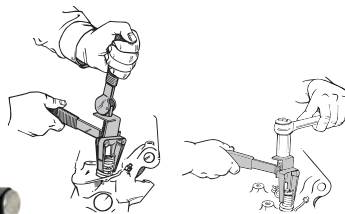

*WHEN SPACE PROHIBITS USE OF CAM HANDLE, REPLACE HANDLE WITH BOLT AND TURN WITH SOCKET.

23300 SMALL ENGINE VALVE SPRING COMPRESSOR

For Springs 3/4" to 1-1/16".

Heavy-duty frame and screw for rigidity. Two jaw sizes. For Briggs and Stratton, Clinton, Harley-Davidson, etc.

23300 Small Engine Valve Spring Compressor. Skin-Packed. Shipping wt. 1 lb.



23360
LARGE JAW

23370
SMALL JAW

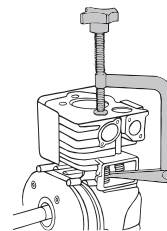

44300 VALVE SPRING COMPRESSOR

High Leverage Allows One-Hand Operation.

Exceptionally strong, rigid frame, weighs only 6 lbs. Works with nearly all valve-in head and L-head engines as well as truck and tractor engines.

44300 Valve Spring Compressor. Box. Shipping wt. 8 lbs. 4 oz.

44770 Set of Offset Jaws. 7/8" to 2-1/4" (22.2 - 57.1mm) capacity.

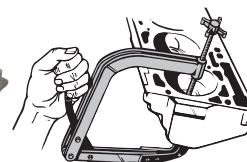

16560 VALVE SPRING COMPRESSOR FOR GM LS

Works on Most GM LS-Type Engines.

Allows removal of the valve spring without removing the rocker stand or other rockers. Can be used on or off the vehicle.

16560 GM LS Valve Spring Compressor. Skin-Packed. Shipping wt. 5 oz.

16270 Hex Socket Screw 16520 Compressor Body

25840 Hex Nut M8 X 1.25 91690 Washer



YouTube

64600 SPARK PLUG TUBE SEAL INSTALLER

Used to Replace Seals in Valve Covers on Honda 2.4 and 3.5L Engines.

The tool helps prevent damage to the seal and valve cover. The seals are replaced to prevent them from going bad which would allow oil to leak on spark plugs causing a misfire to the engine. The tube seal installer fits many Honda and Acura vehicles from 1994 to 2016.

64600 Spark Plug Tube Seal Installer. Skin-Packed. Shipping wt. 10 oz.

22820 Replacement Bearing and Dust Shield

64610 Tube Seal Installer

64620 Washer, 1/2"

64630 Bolt, 1/2"-13 x 1.75



YouTube

36050 VALVE KEEPER REMOVER & INSTALLER KIT

Quickly Removes and Installs Valve Keepers On Most Overhead Valve Engines With Valve Stems From 4.5 to 7.5mm and 5/16" to 3/8".

Makes valve component disassembly and reassembly fast and easy. Push or tap tool with a hammer to remove valve keepers. Magnet in tool body captures keepers for quick removal and valve disassembly. To install keepers, load in retainer on valve stem, then push or tap handle to install. Can be used on the car or bench. New smaller size works on Toyota four cylinder and Chrysler New World Engine applications.

36050 Valve Keeper Remover & Installer Kit. Molded Case. Shipping wt. 2 lbs. 4 oz.

36330 Mercedes Adapter

36340 Installer

36380 Handle Assembly

36440 Metric Installer

36740 Metric Handle Assembly



36330



36380



36340



36740



36440



36200 VALVE KEEPER REMOVER & INSTALLER

36200 Valve Keeper Remover & Installer. Skin-Packed. Shipping wt. 2 lbs. 12 oz.

36330 Mercedes Adapter

36340 Installer

36380 Handle Assembly



34350 WATER SENSOR WRENCH FOR DURAMAX

Removes & Installs the Water Sensor on 2001 - 2011 6.6L Duramax Diesel Engines.

Use when replacing the fuel filter or when servicing the water sensor. Plastic sensor has a 12 sided design that is easily damaged by tools, like pliers, that do not specifically fit the sensor.

34350 Water Sensor Wrench for Duramax. Skin-Packed. Shipping wt. 7 oz.

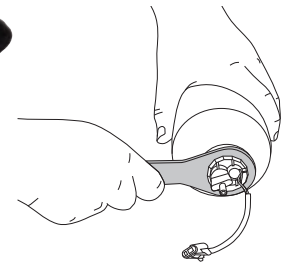

34900 WATER SENSOR WRENCH, LATE MODEL

Removes and Installs the Water Sensor Located on the Fuel Filter on 2012 and Newer 6.6L Duramax Diesel Engines.

Also works on 2013 and newer 6.7L Cummins. For use when replacing the fuel filter or when servicing the water sensor. The plastic sensor has a new hex design that is easily damaged by tools, like pliers, that do not specifically fit the sensor. Use the 34350 or 34910 for older applications.

34900 Water Sensor Wrench, Late Model. Skin-Packed. Shipping wt. 6 oz.



23500 STONE-TYPE GLAZE BREAKER

Full 2" to 7" Range (50.8 - 177.8mm).

Controlled pressure assures positive, adjustable contact through full range. Operates with any electric drill. Furnished with 3" long 220 grit stones, see below for other grits.

Adjustable stop collar permits quick selection of two range settings, from 2" to 4" and from 4" to 7". Stone arms are easily compressed to eliminate cylinder scratches.

23500 Glaze Breaker. Range 2" to 7". Skin-Packed. Shipping wt. 1 lb. 5 oz.

23520 Set Replacement Stones, 220 grit. Skin-Packed. Shipping wt. 3 oz.

23530 Set Special Hard Stones, 240 grit. For use after re-boring only.

Not for glaze breaking. Skin-Packed. Shipping wt. 3 oz.

23540 Set Replacement Stones, 320 grit. Suitable for use when installing moly rings. Skin-Packed. Shipping wt. 3 oz.

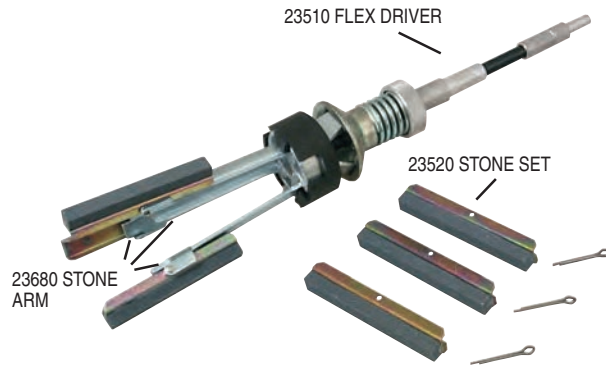

15000 ENGINE CYLINDER HONE

Best by Far - Yet Competitively Priced.

Micrometer head assures accuracy in feeding. Expands quickly to cylinder size with fast action rack and pinion. Bottom guard plate helps prevent stones from accidentally hitting the crankshaft. Universal joint action makes grinding of back cylinder easy. Clip-on stones and wipers are easily changed in a few seconds. Stones are available in five grits. Stone for Nikasil cylinders available. See chart. Use with heavy-duty 1/2" drill. Standard range 3" to 4-1/4". Big range (2 3/4" - 10-1/4") with additional rack sets and stone sets. Long 5" stones cut faster, more accurately.

15000 Engine Cylinder Hone Set. NSN 4910-00-554-9245. Shipping wt. 6 lbs. 2 oz.

Includes the following: Cylinder hone body with 1 set of 15540 standard range rack (range is 3" to 4-1/4"). 1 set each of 15500 coarse stones and 15510 medium stones, cleaning brush and dressing paddle in a sturdy storage case.

See chart for rack sets and stone and wiper sets available. All stone and wiper sets consist of two stones and two wipers. Order by part number. All are 5 inches long, and weigh 7 oz.

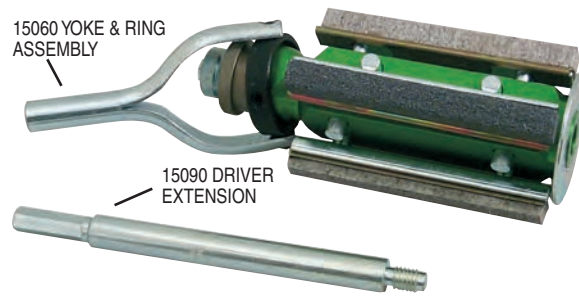

Cylinder Size Range	Rack Set Part No. Weight	Stone and Wiper Set Part Numbers				Special Hard Bond for Steel 150 Grit
		80 Grit	180 Grit	280 Grit	500 Grit	
2 3/4" - 3 3/4" 69.8 - 95mm	15550 1 lb.	15680 *15740	15690	15700	----	----
3" - 4 1/4" 76.2 - 108mm	15540 1 lb. 2 oz.	15500	15510	15520	15990	15490
4" - 6 1/4" 100 - 158mm	15530 1 lb. 6 oz.	15500	15510	15520	15990	15490
6 1/8" - 10 1/4" 155 - 260mm	15560 1 lb. 14 oz.	15500	15510	15520	15990	15490

* For Nikasil Cylinders

16000 SMALL CYLINDER HONE

For 1-3/4" to 2-3/4" (44.5 - 69.9mm) Cylinders.

Precision built for small cylinders. Stones are 3-1/2" long, assuring unusual accuracy. Stones cover full range, are easily changed, and available in four grits. Comes complete with 16410, 16420 and 16430 medium grit stone sets in sturdy storage case. Stones for Nikasil cylinders available. See chart.

16000 Small Cylinder Hone. Range 1-3/4" to 2-3/4". Shipping wt. 4 lbs. 10 oz.

See chart for rack sets and stone and wiper sets available. All stone and wiper sets consist of two stones and two wipers. Order by part number. All are 3-1/2 inches long, and weigh 3 oz.

Cylinder Size Range	Stone and Wiper Set Part Numbers			
	80 Grit	180 Grit	280 Grit	For Alum
1.75" - 2.20" 44.5 - 55.9mm	16440	16410	16380	16470
2.05" - 2.50" 52 - 63.5mm	16450	16420	15520	15990
2.35" - 2.75" 59.6 - 69.9mm	16460	16420 *16590	16400	---

* For Nikasil Cylinders

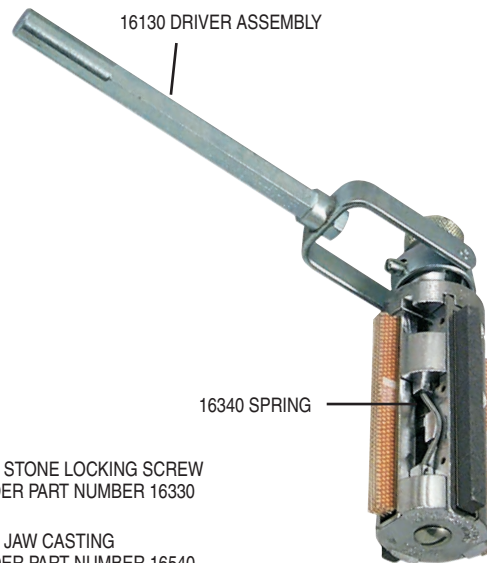

FOR STONE LOCKING SCREW
ORDER PART NUMBER 16330

FOR JAW CASTING
ORDER PART NUMBER 16540

65600 BROKEN SPARK PLUG REMOVER FOR FORD TRITON 3 VALVE ENGINES

YouTube

Set Includes a Unique Porcelain Pusher Tool.

This tool set removes broken spark plugs from 2004 to 2008 Triton 3 valve per cylinder engines, (a common problem). The set includes a unique porcelain pusher tool and a tapered left-hand thread remover for removing the broken spark plug without leaving the porcelain in the engine cylinder. Porcelain pusher is used to press the porcelain piece, without breaking the porcelain, farther into the plug tip. This provides space for the left hand thread remover to bite into the stainless steel plug tip so it can then be pulled.

65600 Broken Spark Plug Remover for Ford. Molded Case. Shipping wt. 1 lb. 13 oz.

58980 Gasket (x4)

65610 Puller Housing

65620 Puller Screw

65660 Left Hand Hex Nut

65670 Porcelain Pusher Assembly



PUSHING PORCELAIN

PULLING BROKEN PLUG

U.S. Pat No. 7,814,814

65700 BROKEN SPARK PLUG REMOVER KIT FOR FORD TRITON 3 VALVE ENGINES

YouTube

The Popular Broken Plug Tip Remover Plus a Special Porcelain Puller Tool.

A kit for removing spark plugs that have seized in the engine head. Includes a Porcelain Puller Tool that locks onto the terminal of a broken spark plug to pull the porcelain if only the metal collar of the plug came loose. Also includes a Porcelain Pusher for when the porcelain breaks off in the spark plug tip and a Self-Tapping Puller to remove the seized metal tip. Comes in a blow molded plastic case for storage. Order Lisle 65710 for the Porcelain Puller individually, or 65730 for the Porcelain Puller, Right Hand Hex Nut and Puller Housing.

65700 Broken Plug Rmvr Kit Ford. Molded Case. Shipping wt. 2 lbs. 3 oz.

58980 Gasket (x4)

65610 Puller Housing

65620 Puller Screw

65660 Left Hand Hex Nut

65670 Porcelain Pusher Assembly

65710 Porcelain Puller

65720 Right Hand Hex Nut

65730 Porcelain Plr w/Housing



U.S. Pat No. 9,539,712

65200 DEEP HOLE ALUMINUM HEAD M14X1.25 SPARK PLUG HOLE REPAIR KIT

Supersedes 65000

Replaces Stripped Spark Plug Threads in Aluminum Heads with 14mm Spark Plugs.

Installs a new solid steel spark plug thread insert in original thread location. Set includes one-piece drill tap, long tap holder, short tap holder, insert installer, swedger and handle. Includes four insert sizes: 5/16", 7/16", 11/16" and 1".

65200 Deep Hole Al Head M14x1.25 Spark Plug Hole Repair Kit. Molded Case.

Shipping wt. 1 lb. 7 oz.

65010 Drill Tap

65020 Long Tap Holder

65030 11/16" Insert (5 pack)

65040 Swedger

65060 7/16" Insert (5 pack)

65070 Short Tap Holder

65080 5/16" Insert (5 pack)

65090 Insert Installer

65100 Swedger Handle

65110 1" Insert (5 Pack)

66160 Set Screw



22100 FLYWHEEL LOCKING TOOL FOR 6.6L DURAMAX

Locks Flywheel in Place When Removing Harmonic Balancer on 6.6L Duramax Engines with Allison Automatic Transmissions.

Saves time by locking the flywheel at the transmission instead of having to remove the starter for water pump replacement. On 2500 and 3500 pickups, remove metal spring-loaded inspection plate on the bottom of the transmission. Tool should slide into opening toward engine with the top of the tool engaging the teeth of the flywheel. On 4500 and 5500 trucks, remove the rubber inspection cap on the bottom of the transmission. Insert the tool at the front of the opening to engage the flywheel and hand tighten bolt to hold tool in place. Use 36mm 12-point socket with 3/4" square drive to remove harmonic balancer bolt and retorque on installation.

22100 Flywheel Locking Tool for 6.6L Duramax. Clam Shell. Shipping wt. 2 lbs.

22090 36mm 12 pt. Socket

22110 Duramax P/U Flywheel Lock

22120 Duramax 4500/5500 Flywheel Lock

22170 Socket Head Cap Screw

22090

22110

22120

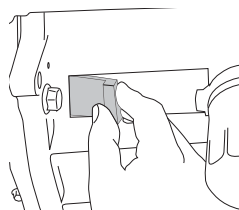

2500 & 3500 PICKUPS

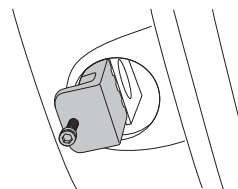

4500 & 5500 TRUCKS

23800 FLYWHEEL TURNER

Hold or Turn Flywheels and Flexplates on Most Vehicles.

Use this special wrench to turn the flywheel and rotate the engine. Also holds the flywheel or flexplate when torquing the flywheel or harmonic balancer bolts. Folds for easy storage.

23800 Flywheel Turner. Skin-Packed. Shipping wt. 1 lb. 4 oz.



21100 21200 VALVE LAPPERS

For Hand Lapping Valves.

Thick handles for easy lapping. 21100 has 1-1/8" and 1-3/8" diameter cups for larger valves. 21200 has 5/8"

21100 Large Valve Lapper. Skin-Packed. Shipping wt. 4 oz.

21200 Small Valve Lapper. Skin-Packed. Shipping wt. 2 oz.

UNIQUE LOCKING TAB POSITIVELY SECURES CUPS TO STURDY HANDLES. ELIMINATES SLIPPAGE



21100

21200

19700 VALVE HOLDER

For Both 14mm & 18mm Spark Plug Threads.

Commonly used when valve springs or valve stem seals are replaced. Air pressure helps prevent the valve from falling into the combustion chamber. Comes with two-step fitting for both 14mm & 18mm threads. Heavy duty 12" flexible hose allows easy access to spark plug hole and air supply. Thread fitting to spark plug hole and other end to air supply.

19700 Valve Holder. Skin-Packed. Shipping wt. 5 oz.

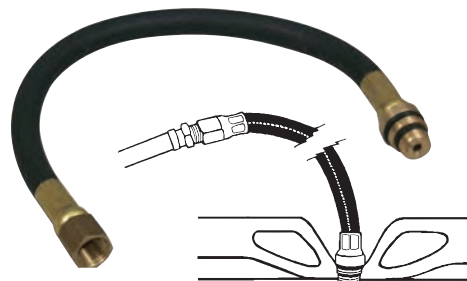

62200 HEATER HOSE COUPLER REMOVER

Removes Broken Heater Hose Couplers.

Drive the tool into the broken coupler. The splines cut their way into the coupler, allowing you to turn it out with a 5/8" socket or wrench.

62200 Heater Hose Coupler Remover. Skin-Packed. Shipping wt. 2 oz.



U.S. Pat No. 6,575,057

22500 THERMOSTAT GASKET CLEANER

Cleans All Hard To Reach Gasket Surfaces.

Use with a die grinder to quickly clean gasket surfaces on Dodge pickups, oil pans, water pumps and other inaccessible applications. The tool is equipped with a floating guide shaft so the user can steer the abrasive pad around the gasket surface. Includes interchangeable short shaft.

22500 Thermostat Gasket Cleaner. Skin-Packed. Shipping weight 4 oz.

22570 Abrasive Pad



U.S. Pat No. 7,001,255

13800 WATER PUMP SPROCKET HOLDER FOR GM ECOTEC

Holds the Timing Chain and Gear in Place While Removing or Installing Water Pump on Ecotec Engines.

Securely holds water pump sprocket preventing loss of timing or damage to the engine. Special half-moon design allows easier access to water pump gear bolts. Uses access cover bolts to hold the tool in place.

13800 Water Pump Sprocket Holder for GM Ecotec. Skin-Packed. Shipping wt. 4 oz.

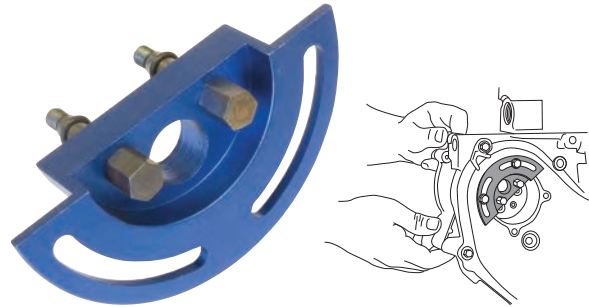

14440 WATER PUMP WRENCH FOR GM NORTHSTAR

Removes & Installs the Water Pump Assembly on GM Northstar 4.0L & 4.6L Engines.

Turn the tool with a 1/2" drive ratchet or breaker bar. Angled teeth prevent the tool from slipping.

14440 Water Pump Wrench for GM Northstar. Hang Tag. Shipping wt. 15 oz.

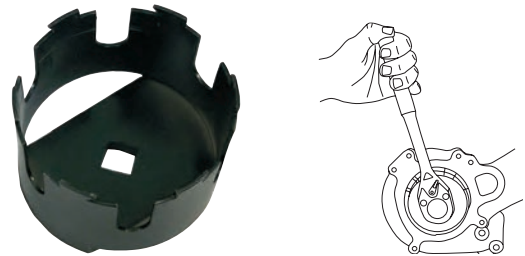

13500 41MM WATER PUMP WRENCH FOR GM 1.6L

Easily Adjust and Hold the Water Pump When Replacing or Adjusting Timing Belt.

Stubby tool design allows access to timing belt sprocket without interference from vehicle frame. Works on 1.6L engines in 2004-current Chevrolet Aveo excluding 2009 with variable timing engine and 1999-2002 Daewoo Lanos. Heat-treated alloy steel for strength. Use with 3/8" square drive and short extension.

13500 41MM Water Pump Wrench for GM 1.6L. Mini Pouch. Shipping wt. 6 oz.



18980 PNEUMATIC U-JOINT DRIVER

Quickly Removes the U-Joint Cap from the Drive Shaft on Most Rear Wheel Drive Vehicles.

Use the driver with an air hammer to remove u-joint caps up to 1-5/16" diameter. Prevents damage to drive shaft and axle shaft ears, when presses or chisels are used. On some vehicles the u-joint is retained with plastic from the factory. The plastic must be removed prior to driving out the u-joint caps.

18980 Pneumatic U-Joint Driver. Skin-Packed. Shipping wt. 1 lb. 4 oz.

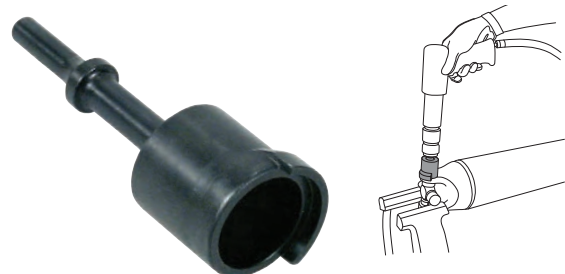

18000 UNIVERSAL CAMSHAFT BEARING TOOL

Drives Camshaft Bearings Smoothly.

Now, one complete low cost set that will remove or insert camshaft bearings in nearly all engines from compact cars to heavy trucks. Range of 1.125" to 2.69" (28.58 - 68.3mm). **EASY ON BEARINGS.** The expander has a neoprene sleeve over which the split driving collets are mounted and expanded to size. This tool has two sets of rubber sleeves supplied with it for each expanding collet. The brown sleeves are used when driving thin wall bearings (.065). The black sleeves should be used when driving thick wall bearings (.090). Instruction sheet T18000 provides complete, illustrated operating instructions and parts list.

18000 Universal Camshaft Bearing Tool. Molded Case. Shipping wt. 11 lbs. 4 oz.

Range 1.125" to 2.690". Includes: Driving shaft, driving shaft extension, expander unit, five (5) expanding collets, five (5) sleeve sets, two (2) driving collars, centering cone & blow molded case.

Shipping wt. 17 lb. NSN 5120-00-878-8541

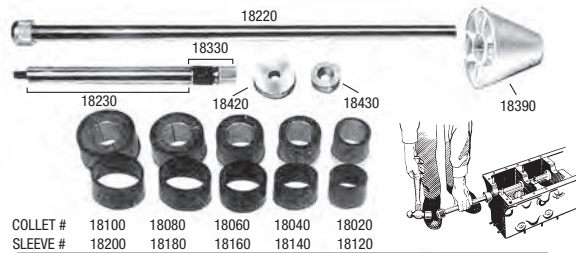

COLLET #	18100	18080	18060	18040	18020
SLEEVE #	18200	18180	18160	18140	18120

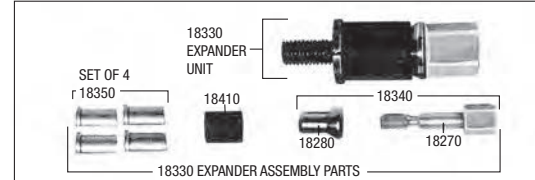

DRIVER RANGE TABLE

BEARING SIZE I.D.	EXPANDING COLLET #	USE WASHER	SLEEVE SET #
1.125 TO 1.475	Expander ass'y 18330	18430	18410
1.475 TO 1.700	18020	18430	18120
1.700 TO 1.925	18040	18420	18140
1.925 TO 2.150	18060	18420	18160
2.150 TO 2.375	18080	18420	18180
2.375 TO 2.690	18100	18420	18200

ENGINE

37950 CAMSHAFT LOCK TOOL FOR HONDA



Accurately Lines Up and Holds Cams for Proper Timing Chain Alignment on Honda K-Series Engines.

Insert the pins into the camshaft pulse plates to lock the cams in place on K20 and K24 engines found on Honda and Acura applications like: Civic, Accord/Integra, CRV/RSX, Odyssey and Element.

37950 Camshaft Lock Tool for Honda. Hang Card. Shipping wt. 3 oz.



58430 SHAFT IN SEAL PULLER

Removes Cam Shaft and Crank Shaft Seals Without Damage to the Shaft.

Engage the adjustable hook behind the seal. Brace the push rod against the engine head and push the handle to remove the seal. Removes the seal without damage to the shaft.

58430 Shaft In Seal Puller. Skin-Packed. Shipping wt. 6 oz.

58500 Hook



27000 SNEAKY PETE

Removes and Installs Upper Rear Main Seals Without Dropping Crankshaft.

The Lisle 27000 includes everything needed to speed up a long, slow job. Cork screw puller makes it easy to remove old seal. To install new seal, 27000 includes a pulling wire with a removable T-handle and spring steel clip that grips the seal firmly as it is pulled into position. Two extra clips are furnished. Saves many times its cost every time it is used.

27000 Sneaky Pete. Skin-Packed. Shipping wt. 2 oz.

27020 Replacement Jaw Clip

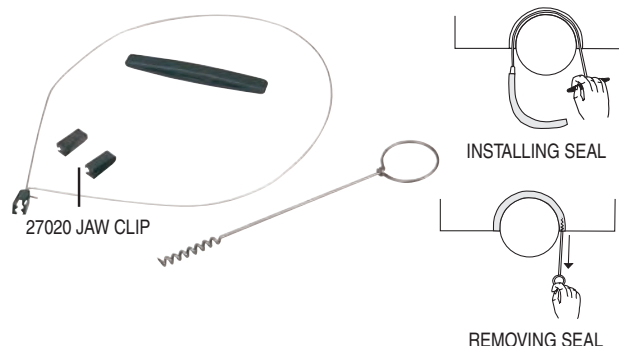

36880 DUAL OVERHEAD CAM (DOHC) LOCK TOOL

Locks Camshaft Sprockets in Place During Belt / Chain Replacement.

This versatile tool easily locks and holds both camshaft sprockets firmly in place. Unique design uses knurled pins to hold against the inside of the cam sprockets. The two parallel bars "float" which allows the knurled pins to align with the sprockets. Preserves the engine timing during belt or chain replacement.

36880 Dual Overhead Cam Lock Tool. Skin-Packed. Shipping wt. 10 oz.

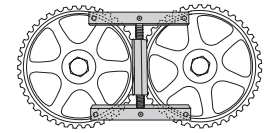

PINS HOLD AGAINST THE INSIDE OF THE CAM SPROCKETS

U.S. Pat No. 6,694,587

37410 CAMSHAFT ALIGNMENT KIT

For Servicing the Timing Belt, Chains, Head Gaskets, or Other Valve Train Repairs on Ford, Mercury and Mazda Vehicles.

The kit comes with an aluminum camshaft bar, plus one short top dead center (TDC) timing pin and one long TDC timing pin. The camshaft bar and long TDC timing pin are used on 2.0L DOHC Zetec engines found in 1994-2003 Ford and Mercury vehicles. The camshaft bar and short TDC timing pin are used on 2004-2012 2.5L DOHC, 2.3L DOHC 4V and 2.0L DOHC engines that are found in Ford, Mercury and Mazda vehicles. The camshaft alignment bar can also be used by itself on 2.0L DOHC engines in 1993-1994 Ford Probe.

37410 Camshaft Alignment Kit. Skin-Packed. Shipping wt. 6 oz.

37420 Timing Bar

37430 Short Timing Pin

37440 Long Timing Pin



YouTube

28500 STRAP WRENCH

Loosen or Tighten Cylindrical or Rectangular Objects.

Handy, self-tightening strap wrench won't slip. Works great for installing or removing timing belt sprockets or belt pulleys. Range from 1" to 6-5/8" round. Tensile strength of strap is 1350 P.S.I. Handle is made of glass-filled polypropylene which provides superior strength.

28500 Strap Wrench. Skin-Packed. Shipping wt. 10 oz.

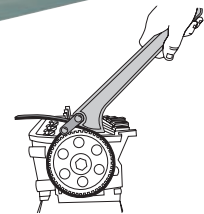

38220 UNIVERSAL CAM ADJUSTER

Adjusts to Fit Different Sized Cam Sprockets.

This adjustable tool is designed to both hold and turn cam sprockets. The tool is needed to turn the cam sprockets to adjust the cam position. It can also be used to hold the cam sprocket in place when removing the cam bolt. It will work on all single and dual overhead cam sprockets with holes.

38220 Universal Cam Adjuster. Skin-Packed. Shipping wt. 1 lb. 2 oz.

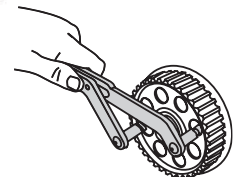

12180 SOOT SENSOR THREAD CHASER M22X1.5

Cleans Threads in Soot Sensor Holes.

Use with 7/8" hex socket or 3/8" square drive.

Important: Use anti-seize.

12180 Soot Sensor Thread Chaser M22. Skin-Packed. Shipping wt. 4 oz.

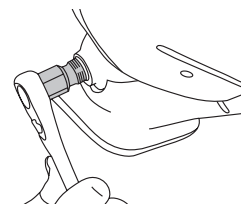

12290 NOX & SOOT SENSOR SOCKET SET

Designed for Easy Access on NOx and Soot Sensors.

Includes 24mm & 30mm offset sockets with 1/2" drive. Each socket has 6 and 12 point options. Works on 3.0L EcoDiesel V6 engines found in Jeep Grand Cherokee & Dodge Ram 1500 Trucks.

12290 NOx & Soot Sensor Socket Set. Skin-Packed. Shipping wt. 1 lb. 5 oz.

12300 NOx Socket, 24mm

12310 NOx Socket, 30mm



12230 OXYGEN SENSOR THREAD CHASER

Cleans Threads in Oxygen Sensor Holes.

Use with 3/4" hex socket or 3/8" square drive. Size: M18x1.5 Also works on M18x1.5 spark plug threads. IMPORTANT: Use anti-seize.

12230 Oxygen Sensor Thread Chaser. Skin-Packed. Shipping wt. 3 oz.

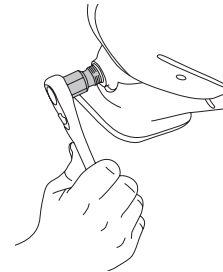

12100 OXYGEN SENSOR SOCKET

Removes and Installs Oxygen Sensors on Most Domestic and Some Imports.

Special 7/8" socket with cutaway slot to provide clearance for wire harness. Provides adequate depth to fit over sensor. Heat-treated alloy steel. Use with 3/8" square drive or 1" wrench.

12100 Oxygen Sensor Socket. Hang Tag. Shipping wt. 9 oz.

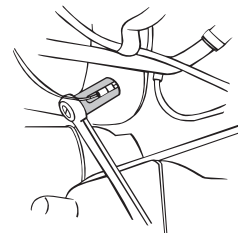

12390 DUAL DRIVE OXYGEN SENSOR WRENCH

Use with a Breaker Bar to Loosen Stubborn Oxygen Sensors. 1/2" and 3/8" drive.

Attach a 1/2" breaker bar on the end of the tool to initially loosen stuck sensors. Use a 3/8" ratchet on the top for fast removal and installation. Slotted body allows clearance for wire harnesses. Forged, heat-treated steel with six point design will withstand high torque removal applications.

12390 Dual Drive Oxygen Sensor Wrench. Skin-Packed. Shipping wt. 10 oz.

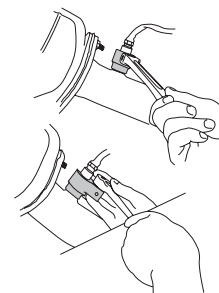

13000 EXHAUST MANIFOLD SPREADER

For Reinstalling the Manifold on Small Block Chevrolets.

A simple way to expand a warped manifold so all bolt holes are accurately aligned. Helps prevent cross-threading of manifold bolts. Works best when used in pairs. Or install before removing manifold to prevent misalignment.

13000 Exhaust Manifold Spreader. Skin-Packed. Shipping wt. 6 oz.

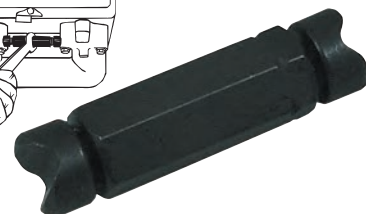
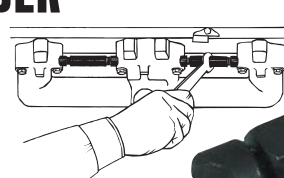

68210 IPR SOCKET FOR FORD 6.0L AND INTERNATIONAL DIESEL

Used to Remove and Replace the Injector Pressure Regulator (IPR) on Ford 6.0L, International and Other Diesel Engines.

The slot in the tool has been modified to fit the larger connectors on injector pressure regulators found on International diesels. On this application the wiring comes out of the top of the regulator. This regulator is located in a very tight location. The tool is built to bottom out on the regulator hex so it does not put torque on the connector in case the regulator can be reused. Use with 3/8" square drive.

68210 IPR Socket for Diesel. Hang Tag. Shipping wt. 8oz.

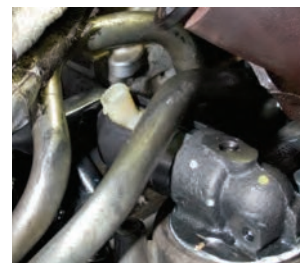

12320 LINE SOCKETS, 19MM & 22MM

Designed to Replace Fuel Line Fittings on Cummins ISB and ISX engines.

The sockets reduce the possibility of fuel leaks and prevent damage to fitting, fuel rail, and fuel line. The 22mm is used on the newest ISX Cummins motors and the 19mm is found on 2011 and older diesel engines. Use with 3/8" square drive.

12320 Line Sockets, 19mm & 22mm. Skin-Packed. Shipping wt. 1 lb.

12330 Line Socket, 19mm

12340 Line Socket, 22mm



12490 LINE SOCKETS, 17MM & 21MM

Designed to Replace Fuel Line Fittings Without Damage to Fitting, Fuel Rail, and Fuel Line Reducing the Possibility of Fuel Leaks.

17mm socket works on Audi A1, A3, A4, A6, A8, Volkswagen Passat, and BMW N54, N63, and S63 engines. 21mm socket works on Paccar MX 11, and MX 13 engines. Use with 3/8" square drive.

12490 Line Sockets, 17mm & 21mm. Skin-Packed. Shipping wt. 14 oz.

12530 Line Socket, 17mm

12540 Line Socket, 21mm



48300 PUSH ROD REMOVER

Redesigned for Newer 3.5L and 3.9L GM Engines. Also Works on 2.8L, 3.1L and 3.4L GM V6 Engines.

Quickly removes push rods so you can replace the intake gasket. No need to loosen and retighten the rocker arm. The tool pivots the rocker arm to compress the valve spring and free the push rod for removal.

48300 Push Rod Remover. Skin-Packed. Shipping wt. 12 oz.



YouTube

13250 OIL PRESSURE SWITCH SOCKET

Fits 1-1/16" Switches Up To 2-5/8" Long, Found on GM and Chrysler Vehicles.

Fits 1-1/16" oil pressure sending unit (gauge type), found on most all '91 and newer GM vehicles. Also fits '87 and newer Chrysler vehicles with combination light and gauge oil pressure switches. Use with 3/8" drive or 1-1/8" hex.

13250 Oil Pressure Switch Socket. Hang Tag. Shipping wt. 8 oz.

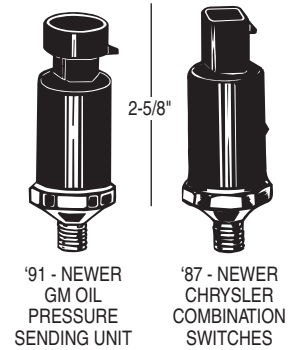

13200 OIL PRESSURE SWITCH SOCKET

Fits 1" and 1-1/16" Switches Up To 1-5/8" Long.

One socket with the correct length to fit 1" and 1-1/16" oil pressure switches (for vehicles equipped with warning lights). 1-7/8" overall height for clearance. Use with 3/8" drive or 1-1/8" hex.

13200 Oil Pressure Switch Socket. Hang Tag. Shipping wt. 5 oz.

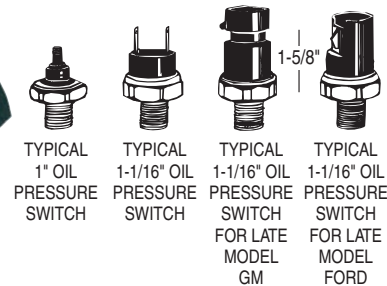

59370 STRETCH BELT REMOVER/INSTALLER

Combination Removal and Installation Tool for Most Stretch Belt Applications Found on Many Accessory Drive Systems.

Unique magnetic faces hold the tool in place on the pulley. Helps prevent damage to belt or pulley during removal or installation. Compact, one-piece tool can be used on the front or back side of the pulley.

59370 Stretch Belt Remover/Installer. Skin-Packed. Shipping wt. 4.5 oz.

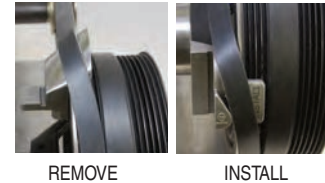

U.S. Pat No. 9,404,560

20250 COMPRESSION TESTER

Quickly and Accurately Check Compression on Gasoline Engines.

Gauge registers 0 - 300 P.S.I. and 0 - 2100 kpa. Fits 14mm and 18mm thread sizes.

20250 Compression Tester. Skin-Packed. Shipping wt. 15 oz.

20100 Valve Core.

20280 14mm Adapter



20530 10MM SPARK PLUG ADAPTER 20540 12MM SPARK PLUG ADAPTER

Spark Plug Thread Adapters for 20250 Compression Tester.

For testing on some automobile, motorcycle, ATV, chainsaw and marine gas engines. Includes o-ring.

20530 10mm Spark Plug Adapter. Mini Pouch. Shipping wt. 3 oz.

20540 12mm Spark Plug Adapter. Mini Pouch. Shipping wt. 3 oz.



20530



20540

75500 COMBUSTION LEAK DETECTOR

Quickly Pinpoints Combustion Leaks.

Detects bad head gaskets, cracked blocks, & cracked or warped heads. Fluid changes from blue to yellow when exposed to combustion gases from the radiator. Connect the hose to any vehicle vacuum line. Place tapered end of tool into radiator opening. With the engine running, the vehicle vacuum or the vacuum pump draws vapors through the indicating fluid for testing.

75500 Combustion Leak Detector. Clam Shell. Shipping wt. 1 lb. 14 oz.

75630 Replacement Fluid. 16 fluid oz.



LEAK DETECTED (FLUID CHANGES TO YELLOW COLOR)

U.S. Pat No. 6,806,092

75730 COMBUSTION LEAK DETECTOR FLUID FOR DIESEL

Detects Combustion Leaks on Diesel Engines.

Use the diesel leak detector fluid with the Lisle 75500 Combustion Leak Detector. Indicating fluid changes from red to yellow when exposed to diesel combustion gases in the radiator. Contains 16 fluid oz.

75730 Combustion Leak Detector Fluid for Diesel. Shipping wt. 1 lb. 4 oz.



NO LEAK PRESENT (NO CHANGE IN FLUID COLOR)



LEAK DETECTED (FLUID CHANGES TO YELLOW COLOR)

20300 VACUUM GAUGE AND FUEL PUMP TESTER

Easy reading gauge.

Assures accurate vacuum and pressure check.

20300 Vacuum Gauge. Skin-Packed. Shipping wt. 9 oz.



53790 HARMONIC BALANCER INSTALLER KIT

Installs Harmonic Balancers or Drive Pulleys that are Pressed on the Crankshaft.

Now includes adapter for Ford 3.5L and 4.0L engines. Set includes driving screw, thrust bearing and 13 threaded adapters necessary to work on a wide range of domestic and some import harmonic balancers. Five long adapters for use on Dodge Hemi, generation III and IV GM motors, some Chrysler. The 1.75" spacer allows the tool to work more effectively on deep harmonic balancers.

53790 Harmonic Balancer Installer Kit. Molded Case. Shipping wt. 5 lb. 8 oz.

52210 Flanged Nut	52220 Thrust Bearing
52230 Driver 52240 Knurled Nut	52250 Spacer
52270 7/16-20 Adapter	52290 M12x1.5 Adapter
52300 1/2-20 Adapter	52320 M14x1.5 Adapter
52330 9/16-18 Adapter	52340 5/8-18 Adapter
52350 M16x2.0 Adapter	52360 3/4-16 Adapter 53470 Spacer
53480 M14x1.5 Adapter, Long	53490 M16x2.0 Adapter, Long
53740 Case for 53790	53770 M12x1.5 Adapter
66720 M12x1.75 Nut	53820 Long 12mm X 1.5 Threaded Shaft
53830 M12 X 1.5 Nut	66860 M12x1.75 Stud

Supersedes 53760



YouTube

52500 MECHANIC'S STETHOSCOPE

Unique Sound Chamber & Super Thin Diaphragm
Greatly Amplifies Sounds.

Quickly pinpoints the source of mechanical noises in engines, transmissions, differentials and bearings.

52500 Stethoscope. Skin-Packed. Shipping wt. 6 oz.



52520 STETHOSCOPE WITH MAGNETIC HOLDER

Includes Magnetic Accessory that can be Attached
to the End of the Stethoscope Probe.

Allows the stethoscope to be held in place hands free so the technician can check for chassis noise without another technician. Unique sound chamber and super thin diaphragm greatly amplifies sounds. Quickly pinpoints the source of noises in engines, transmissions, differentials and bearings.

52520 Stethoscope w/Magnet. Skin-Packed. Shipping wt. 5 oz.

52530 Stethoscope Magnet



ENGINE

52700 AUDIO STETHOSCOPE

Detects Noise From Vacuum Leaks, Exhaust Leaks,
Wind Noise & Air Leaks.

Detects air induced sounds not detected by conventional stethoscopes. Place funnel over suspected air leak.

52700 Audio Stethoscope. Skin-Packed. Shipping wt. 9 oz.



52750 STETHOSCOPE SET

Dual Purpose Set Detects Both Mechanical & Air
Induced Sounds.

Use the black diaphragm chamber & screw-in metal probe to detect mechanical sounds from bearings, engines, transmissions, etc. For air induced sounds, attach the vinyl hose to hollow tube and funnel assembly. The funnel amplifier will detect noises from vacuum leaks, exhaust leaks, air leaks and wind noise. For hard to reach locations, remove the funnel and use the hollow tube.

52750 Stethoscope Set. Clam Shell. Shipping wt. 10 oz.



MECHANICAL SOUNDS

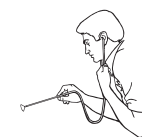

AIR NOISE

39190 HEATER HOSE DISCONNECT FOR GM

Designed to Separate Quick-Connect Fittings on 3/4" Heater Lines on GM Vehicles.

Hinged design allows the tool to slip over the heater hose, even in tight spaces. Slide the tool into the connector to release the line. Aluminum provides strength and durability.

39190 Heater Hose Disconnect for GM. Skin-Packed. Shipping wt. 2 oz.



39200 HEATER HOSE DISCONNECT FOR FORD 2.0L

Disconnects the Heater Hose Fittings on 2012-2016 Ford Focus 2.0L and 2013-2016 Ford Escape 2.0L EcoBoost®.

These type of fittings are close to the firewall behind the engine and are difficult to turn with very little to hang onto to rotate. They only get worse over time with each heat cycle and deposit buildup. Tool engages the tabs and provides a better grip on the fitting.

39200 Heater Hose Disconnect for Ford 2.0L. Skin-Packed. Shipping wt. 2 oz.



37370 GLOW PLUG HARNESS PULLER

Removes and Installs the Wire Harness on Glow Plug Connectors on Ford 6.0L and other Diesel Engines.

Helps prevent damage to the harness and connector rail. It features a thumb tab and a textured highly visible grip that provides a better grip on the tool when removing the harness. The harness is fragile and can break, but with a better grip the technician will have more control when removing the harness. Made of stainless steel for rigidity and durability.

37370 Glow Plug Puller. Skin-Packed. Shipping wt. 2 oz.



YouTube

70080 INJECTION PUMP GAUGE KIT FOR GM

Allows Correct Installation of the High-Pressure Fuel Pump by Ensuring the Fuel Pump Camshaft Lobe is on the Base Circle.

Before installing the new fuel pump, insert the correct gauge into the engine. If the lip of the gauge does not sit flush to the engine, turn the camshaft until the gap is gone. Misalignment and improper torquing of the bolts could lead to damage to the fuel pump or engine camshaft. Used on late model GM Direct Injection engines including 2.5L, 3.6L VVT, 5.3L and 6.2L.

70080 GM V8 Injection Pump Plug Kit. Hang Card. Shipping wt. 14 oz.

70050 GM V8 Injection Pump Plug

70060 GM V6 Injection Pump Plug

70070 GM I4 Injection Pump Plug



YouTube

60800 HEATER CORE BACKFLUSH TOOL WITH AIR

Adjustable Pressure Industrial Spray Gun with Air Adapter and a Stepped Tip Design for Easy Heater Core Flushing.

Air pressure is added to the water flow creating agitation that flushes out even the most stubborn clogs. The tip fits 1/2", 5/8" and 3/4" hose fittings. Water pressure can be easily controlled with one hand by squeezing the handle of the heavy-duty spray gun. The insulated handle protects your hand when using hot water to flush the cooling system. The spray gun attaches to a standard garden hose.

60800 Heater Core Backflush Tool with Air. Skin-Packed. Shipping wt. 1 lb. 2 oz.

60840 Brass Button Valve



60900 HEATER CORE BACKFLUSH TOOL

Adjustable Pressure Industrial Spray Gun and Stepped Tip Design for Easy Heater Core Flushing.

The tip fits 1/2", 5/8" and 3/4" hose fittings. Water pressure can be easily controlled with one hand by squeezing the handle of the heavy-duty spray gun. The insulated handle protects your hand when using hot water to flush the cooling system. The spray gun attaches to a standard garden hose.

60900 Heater Core Backflush Tool. Skin-Packed. Shipping wt. 13 oz.



ENGINE

37230 TIMING TOOL FOR FORD 3.5L TURBO

For Use When Servicing the Timing Chain on 2017 and Newer Ford V6 3.5L Turbo Engines.

Updated design is thicker for more strength. Surfaces are precisely machined for an exact fit. The tool helps ensure camshaft alignment during the removal and installation of the timing chain.

37230 Timing Tool for Ford 3.5L Turbo. Box. Shipping wt. 3 lbs. 8 oz.

37220 Timing Tool, 1 pc.

Supersedes 37350



37200 TIMING TOOL FOR FORD WITH TENSIONER

For Use When Servicing the Timing Chain on Ford V6 3.5L and 3.7L Engines.

Helps ensure camshaft alignment during removal and installation of the timing chain. Includes holding tool for secondary chain tensioner. Applications: 3.5L - 2007 to 2016, non-turbo 2017. 3.7L - 2009 and newer

37200 Timing Tool Ford Set. Box. Shipping wt. 2 lb. 9 oz.

37190 Tensioner Hold Down



Supersedes 37100



37530 TIMING TOOL FOR GM, 4 PC.

For Use When Servicing the Timing Chain on GM 2.8, 2.9, 3.0, 3.5, 3.6, 3.7, and 4.2L Engines. Helps Ensure Camshaft Alignment During Timing Chain Removal and Installation.

Plates 1, 2 and 3 work on 2.8L, 3.0L and 3.6L high feature V6 engines. Plate 4 works on '04-'07 2.8L, '07-'12 2.9L, '04-'06 3.5L, '07-'12 3.7L & '02-'08 4.2L in-line 4, 5 and 6 cylinder engines.

37530 Timing Tool for GM, 4 pc. Box. Shipping wt. 1 lb. 15 oz.

37560 Timing Tool 1 for GM

37570 Timing Tool 2 for GM

37580 Timing Tool 3 for GM

37930 Timing Tool 4 for GM

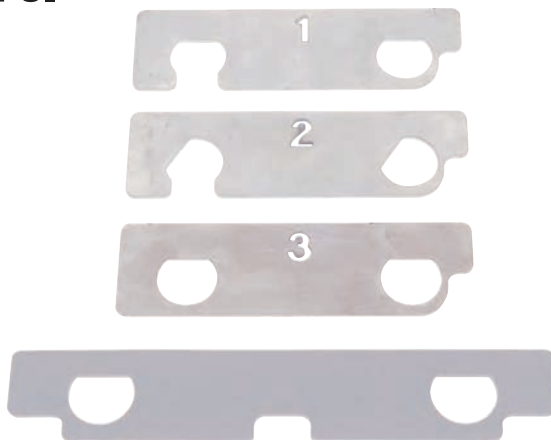

77060 77080 HARMONIC BALANCER SOCKETS

Heavy-Duty Impact Sockets Designed with More Than the Standard Socket Mass to Direct More Energy to Removing the Bolt.

77060 has more than two times the standard socket mass. Can be used on Honda Civic engines that use a 17mm hex pulley damper bolt or other 17mm applications. 77080 can used on Honda Accord engines that use a 19mm hex pulley damper bolt or other 19mm applications. Heat-treated, impact-quality alloy steel. Use with 1/2" drive.

77060 17mm Harmonic Balancer Socket. Box. Shipping wt. 2 lbs.

77080 19mm Harm Bal Sckt Honda. Box. Shipping wt. 2 lbs.



YouTube



U.S. Pat No. 10,040,176

37450 DEF DISCONNECT SET

Compact Design Allows Easy Access to Hard-to-Reach DEF Fill and Breather Lines on 2012 and Newer Ford Power Stroke and Dodge Diesel.

The disconnects are used to depress the locks that retain the DEF lines allowing removal. Three sizes for many applications.

37450 DEF Disconnect Set. Skin-Packed. Shipping wt. 10 oz.

37470 DEF Disconnect Tool, Small

37480 DEF Disconnect Tool, Medium

37490 DEF Disconnect Tool, Large



YouTube



57650 ALTERNATOR DECOUPLER PULLEY TOOL KIT

Five Piece Kit for Removing and Installing Many Alternator Decoupler Pulleys on the Most Popular Vehicles in North America.

Includes Two Pulley Sockets and Three Shaft Bits. Kit Works on Both Overriding Alternator Decoupler (OAD) and One-Way Clutch (OWC) Pulleys. Tools can be used while the alternator is on or off the vehicle.

57650 Alternator Decoupler Pulley Tool Kit. Molded Case. Shipping wt. 18.8 oz.

57610 33T Spline Pulley Socket 57620 10mm Female Hex Shaft Bit

57630 17mm Pulley Socket 57660 T-50 Shaft Bit

57670 10mm Triple Square Shaft Bit



ENGINE

39310 AC DISCONNECT TOOL FOR TOYOTA

Double-Ended Disconnect Tool Works on Plastic Quick-Connect Fittings on Air Conditioning Lines on Most 1998 and Newer Toyota Vehicles.

Works on the high and low-pressure air conditioning lines on many Toyota, Lexus and Scion applications. Can be used on either set of holes on the connector.

39310 Toyota AC Disconnect Tool . Skin-Packed. Shipping wt. 6 oz.

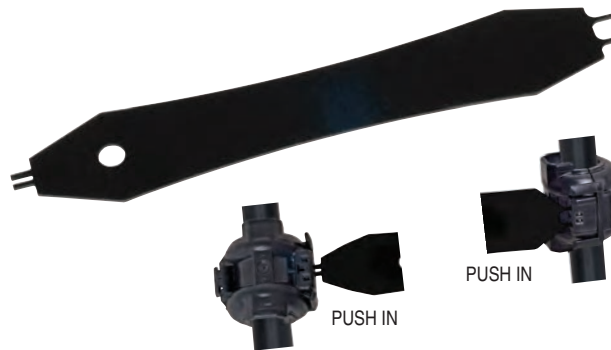

52990 SPARK PLUG PLIERS

Two Pulling Positions Help Make Removing Spark Plug Wires a Safe and Easy Job.

Specially shaped, cushioned jaws grip the boot straight on or from the side. Plastic handle grips help prevent shock.

52990 Spark Plug Pliers. Skin-Packed. Shipping wt. 8 oz.



TUNE UP

51750 ADJUSTABLE SPARK PLUG WIRE PULLER

Jaws Adjust to Five Positions.

Plier jaws adjust to five different positions allowing easier access to spark plug boots. Specially shaped, cushioned jaws grip the boot straight on or from the side. Plastic handle grips help prevent shock.

51750 Adjustable Spark Plug Wire Puller. Skin-Packed. Shipping wt. 10 oz.



51410 SPARK PLUG WIRE REMOVAL PLIERS

Used to Remove Stubborn Spark Plug Wires on GM 3.1L, 3.4L, 3.8L and Other Engines.

The 5/8" opening of the pliers properly fits spark plug wire boots to prevent damage to spark plug wires. Tool is 7" long with offset tip to fit in tight spots.

51410 Spark Plug Wire Removal Pliers. Skin-Packed. Shipping wt. 8 oz.



51420 OFFSET SPARK PLUG WIRE REMOVAL PLIERS

Used to Remove Stubborn Spark Plug Wires.

The 5/8" opening of the pliers properly fits spark plug wire boots to help prevent damage. Offset design works great on boots with heat sleeves found on some GM engines. Easy-to-use in tight spaces such as rear boots on V6 transverse mounted engines. Pliers can also be used on hoses and for holding other objects.

51420 Offset Spark Plug Wire Removal Pliers. Skin-Packed. Shipping wt. 8 oz.



51600 SPARK PLUG WIRE PULLER

Also Pulls Cartridge Fuses.

Jaws are made to pull spark plug boots from different angles. The double-ended tool also pulls cartridge fuses up to 1" in diameter. Made of glass-filled nylon for shock resistance and extra strength.

51600 Spark Plug Wire Puller. Skin-Packed. Shipping wt. 3 oz.



51250 SPARK PLUG WIRE PULLER

Removes Spark Plug Wire Boots from Plugs.

A simple, yet effective tool for disengaging spark plug wire boots. Tool performs well in difficult areas such as recessed and obstructed plugs. Square shaft prevents slipping. Thick plastic handle prevents electric shock & provides greater pulling power.

51250 Spark Plug Wire Puller. Skin-Packed. Shipping wt. 4 oz.

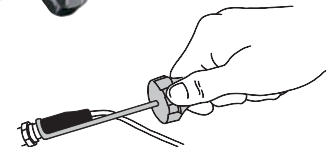
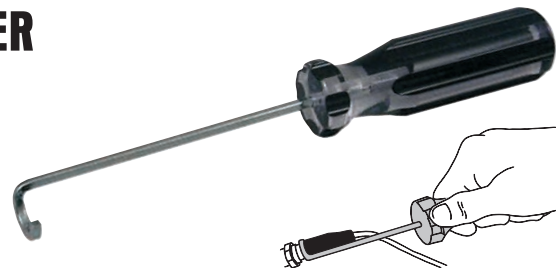

19380 SPARK INDICATOR

Tests Spark Plugs, Spark Plug Wires and Coils Without Puncturing the Wire.

With the engine running, place the grooved end of the aluminum tool over the plug wire. The bulb will flash to indicate spark.

19380 Spark Indicator. Skin-Packed. Shipping wt. 1 oz.

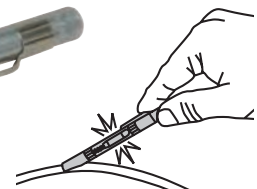

20610 INLINE SPARK TESTER

Gives a Visual Check of the Ignition System.

Quickly diagnose problems with all ignition systems. Connect the tool between the spark plug and the plug wire. The tool is double-ended to offer a straight boot and a 90° boot on one tool. With the engine running, the tool flashes a mirror image of ignition spark.

20610 Inline Spark Tester. Skin-Packed. Shipping wt. 5 oz.

20680 Replacement Bulb



20580 INLINE SPARK TESTER WITH COIL-ON-PLUG WIRE

Gives a Visual Check of Spark Energy for Coil-On-Plug or Standard Ignition Systems.

Connect the tool between the spark plug and the plug wire. The short wire is double ended to offer a straight boot and a 90-degree boot on one tool. With the engine running, the tool flashes a mirror image of the ignition spark. The additional 7" extension plug wire is used on coil-on-plugs that are recessed and hard-to-reach.

20580 Inline Spark Tester w/ Coil on Plug Wire. Skin-Packed. Shipping wt. 8 oz.

20680 Replacement Bulb.



20700 COIL-ON-PLUG SPARK TESTER

Provides an Easy Way to Check Ignition Systems with Coil-On Plugs. Applications Include Ford, Chrysler, Mitsubishi, Nissan and More.

It is the quickest way to test for no-start conditions. An inductive test cannot be performed, because there are no plug wires. High visibility white lettering makes it easy to read the gap measurement from 0 to 40k. The round knob provides easy gap adjustment and the 12" ground wire comes with a shielded clip. The standard plug wire tip can be unscrewed so the tester can be used on small engines and some motorcycles.

20700 Coil-On-Plug Spark Tester. Skin-Packed. Shipping wt. 4 oz.



50850 IGNITION SPARK TESTER

Quickly Checks Spark at Plug Wire.

A handy tool to check ignition spark without removing the spark plug. The tool is specially calibrated to measure ignition voltage. Works on both standard and electronic ignition systems. Simply adjust calibration screw to proper gap size. Attach spark plug wire to end of tester. Clamp tester on engine to ground. Crank engine and check for spark.

50850 Ignition Spark Tester. Skin-Packed. Shipping wt. 2 oz.

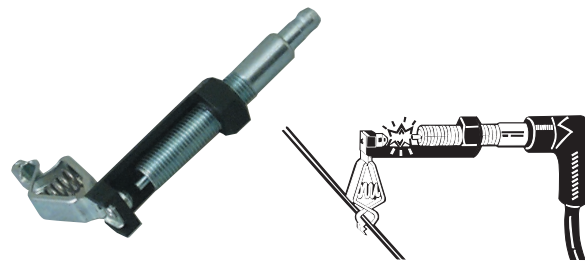

20200 SPARK PLUG HOLE AND OXYGEN SENSOR THREAD CHASER

Double-Ended for Both 14mm & 18mm Threads.

Cleans threads in spark plug holes, also oxygen sensor holes. Use with 3/4" spark plug socket.

20200 Spark Plug Hole Thread Chaser. Skin-Packed. Shipping wt. 5 oz.



20020 LIMITED ACCESS SPARK PLUG CHASER M14X1.25

Fits Spark Plug Holes with Limited Access.

The narrow profile and long length allows access to spark plug holes in confined spaces. Use with a 3/8" ratchet or extension. Size: M14x1.25. **IMPORTANT:** Use anti-seize.

20020 Limited Access Spark Plug Chaser. Skin-Packed. Shipping wt. 3 oz.



63070 16MM SPARK PLUG SOCKET, 12 PT.

Thin Wall, 16mm, 12 pt. Socket with Swivel to Remove and Replace Spark Plugs from Narrow Tubes.

Magnetic insert holds the spark plug in the socket during removal and installation. Works on some BMW, Chrysler, Dodge, Jeep, Honda, Acura, Mercedes, and Mini. Use with 3/8" square drive.

63070 16mm Spark Plug Socket, 12pt. Hang Tag. Shipping wt. 5 oz.



63080 14MM SPARK PLUG SOCKET, 12 PT.

Thin Wall, 14mm, 12 pt. Socket with Swivel to Remove and Replace Spark Plugs from Narrow Tubes.

Rubber insert holds the spark plug in the socket during removal and installation. Use with 3/8" square drive.

63080 14mm Spark Plug Socket, 12 pt. Hang Tag. Shipping wt. 4 oz.



20750 REMOTE STARTER

Tough, Smooth-working, Reliable Switch.

Features heavy gauge, rubber-covered copper wire. Depress button to jog or start the engine.

20750 Remote Starter. Skin-Packed. Shipping wt. 6 oz.



55250 CARBURETOR ADJUSTING TOOL

Heavy-duty flexible shaft for easy access.

Four adapters with vinyl holder for storage.

55250 Carburetor Adjusting Tool Skin-Packed. Shipping wt. 5 oz.

55300 "Double D" for GM, '79 thru '88.

55310 1/4" Hex for pre-'78 GM.

55320 3/32" Hex for '78 through '85 Chrysler 1.7L - 2.2L engines.

55330 4.5mm Hex for '78 and '79 GM.

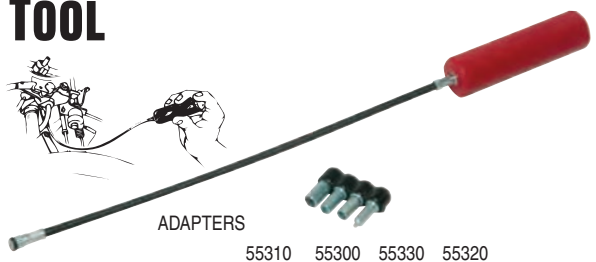

75000 VACUUM PUMP

Heavy Duty Pump that is Field Repairable.

The pump is made of one-piece zinc die cast material for durability and improved performance. Checks all vacuum operated components on car. Pump comes with a detailed, illustrated manual covering vacuum testing. Worn o-rings, seals and valves can be replaced with the 75400 repair kit.

75000 Vacuum Pump. Skin-Packed. Shipping wt. 1 lb. 10 oz.

75400 Vacuum Pump Repair Kit. Bagged. Shipping wt. 1 oz.

CHECKING VACUUM
ADVANCE CHAMBER



70160 GAUGE

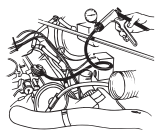

CHECKING
EGR VALVE

24780 SPILL-FREE® FUNNEL, 18 PC.

Includes New Cap for Ford and Additional Straight Extension.

Clear funnel allows a quick visual check of the coolant from across the shop. Comes with a lid to keep contaminants out as well as store the caps and adapters. Eliminates trapped air pockets which usually cause erratic cooling system and heater performance. It controls the proper amount of coolant entering system and enables unattended filling of the cooling system. The funnel eliminates squeaky belts caused by coolant overflow and protects the environment. Five different colored radiator adapters and six caps to fit most cars, pickups, trucks and many farm tractors. Two straight extensions and two 45° elbows for angled and hard-to-reach applications.

24780 Spill-Free® Funnel, 18 pc. Label. Shipping wt. 1 lb. 3 oz.

21920 Lid	22210 Funnel
22240 Red Adapter B	22280 45° Elbow
22300 Fluid Stopper	22330 Large Cap A
22340 Medium Cap B	22410 Small Cap C
23130 Black Adapter A	23140 Blue Adapter E
23150 Green Adapter C	23160 Purple Adapter D
23180 VW / Audi / Porsche Cap	24640 Threaded Cap D for GM
24670 Extension	24690 Threaded Cap F for Ford (NEW)

Supersedes 24970



RADIATOR

24680 SPILL-FREE® FUNNEL

Clear Funnel Allows a Quick Visual Check of the Coolant from Across the Shop.

Comes with a lid to keep contaminants out as well as store the caps and adapters. Eliminates trapped air pockets which usually cause erratic cooling system and heater performance. It controls the proper amount of coolant entering system and enables unattended filling of the cooling system. The funnel eliminates squeaky belts caused by coolant overflow and protects the environment. Five adapters fit most domestic and import cars and light trucks including newer GM "threaded style" radiator openings and Ford surge tanks. Straight extension and 45° elbows allow use on radiator caps that are placed at an angle or other hard-to-reach applications.

24680 Spill-Free® Funnel. Label. Shipping wt. 1 lb. 3 oz.

21920 Lid	22210 Funnel
22240 Red Adapter B	22280 45° Elbow
22300 Fluid Stopper	22330 Large Cap A
22340 Medium Cap B	22410 Small Cap C
23130 Black Adapter A	23140 Blue Adapter E
23150 Green Adapter C	23160 Purple Adapter D
24640 Threaded Cap D for GM	24670 Extension



19912 MULTI-APPLICATION OIL FUNNEL, 14 PC.

Includes Two New Adapters for Volvo and Chrysler/Dodge/Jeep.

Helps eliminate oil spills when refilling crankcases, especially those with baffle valve covers. The 1.6 qt. translucent funnel comes with 14 different color-coded adapters and a 45° elbow to work on many applications and save valuable storage space. Adapter holders keep adapters organized in toolbox or on pegboard. Use spout only as a standard funnel. The adapters fit crankcases securely. Tethered lid and cap keep the funnel clean.

Supersedes 19342
19612
19622



19912 Multi-Application Oil Funnel, 12 pc. Box. Shipping wt. 2 lbs. 1 oz.

18832 Funnel Body, Gray

19352 GM/Ford Adapter w/ O-Ring, Black

19362 Ford/Mazda Adapter w/ O-Ring, Blue

19372 Toyota/Lexus Adapter w/ Gasket, Yellow

19382 Honda/Acura/Nissan Adapter w/ Gasket, Green

19392 VW/Audi Adapter w/ Gasket, Maroon

19402 Chrysler Adapter w/ O-Ring, Purple

19412 Toyota/Lexus Adapter w/ Gasket, Orange

19452 Subaru Adapter w/ Gasket, Neon Red

19472 GM Adapter w/ Gasket, Teal

19482 Audi/VW Adapter w/ Gasket, Tan

19492 Hyundai/KIA Adapter w/ Gasket, Royal Blue

19422 Straight Adapter, Clear

9432 Elbow 45 Degree, Black

19442 Tethered Lid, Red

19532 Tethered Spout Cap, Red

19502 Chrysler Adapter w/ Gasket, Mid Gray

19512 Jeep/Chrysler Adapter, Gold (NEW)

19522 Volvo Adapter, Light Green (NEW)

19632 Adapter Holder Base 1 pc.

19672 Adapter Holder Inserts 5 pc.

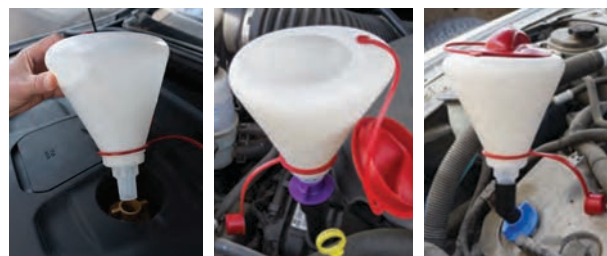

U.S. Pat. No. 10,450,180, D803045, D803046, D803048, D803047, D804945, D803049, D803050, D828751, D828752, D861053

24210 SPILL-FREE® DEF KIT WITH ADAPTER FOR GM

The Adapter Securely Holds the Funnel in Place for Safe and Spill-Free Filling on 2011 to 2019 Duramax Vehicles. Also Works on Side Fill Vehicles.

Translucent funnel with 6" opening provides a visual check to see fluid levels when filling tank. Includes 5" extension and 45° elbow for hard-to-reach DEF fill ports. Lid to keep contaminants out as well as storage for parts. Important: DEF is corrosive for some metallic surfaces.

24210 Spill-Free® DEF Kit with GM Adapter. Label. Shipping wt. 12 oz.

21920 Lid

22210 Funnel

24220 DEF Adapter for GM 24230 Fluid Stopper, Blue

24240 45 Degree Elbow, Blue

24250 5" Straight Extension, Blue



18232 OFFSET FUNNEL WITH SPOUT CAP AND LID

17232 RIGHT ANGLE FUNNEL

10" Tall Translucent Funnel with a 6-3/4" Offset from Center of Mouth to Center of Spout for Hard-to-Reach Applications.

Useful for adding brake fluid to master cylinders on mini-vans, adding gear lube to differentials, filling the DEF reservoir on GM Duramax diesels as well as other applications.

18232 Offset Funnel with Spout Cap and Lid. Label. Shipping wt. 8 oz.

17232 Right Angle Funnel. Color Label. Shipping wt. 4 oz.

17242 Retro Upgrade Kit for 17232

18242 Lid, Black

18252 Nozzle

19692 Spout Cap, Black



19802 THREADED OIL / TRANSMISSION FUNNEL

Hands-Free Filling on Threaded Valve Cover Openings.

Two-piece design can be used separately or threaded together for a long super funnel. The larger section screws into threaded oil filler openings, found on many Ford pickups and Dodge, Jeep & Chrysler cars, mini vans & SUVs. This holds the funnel upright for quick, mess free oil fills. Also works on some Honda, Acura and Nissan vehicles. The diameter of the smaller funnel is narrow enough to fit even the smallest applications including transmission filler holes.

19802 Threaded Oil/Transmission Funnel. Label. Shipping wt. 4 oz.



19832 1.6 QT. PLASTIC FUNNEL WITH LID & SPOUT CAP

Handy 1.6 qt. Polypropylene Funnel has a Removable 9" Flexible Spout and Narrow Design for Hard-to-Reach Applications.

Includes a lid and spout cap to keep contaminants out. A 4" opening for the lid creates a lip to prevent excess fluid from dripping out of the top when the funnel is laid down after use. Translucent material allows the technician to see the fluid inside the funnel.

19832 1.6 qt. Plastic Funnel w/Lid & Spout Cap. Label. Shipping wt. 7 oz.

19682 Lid

19692 Spout Cap

19742 White Spout & Threaded Collar

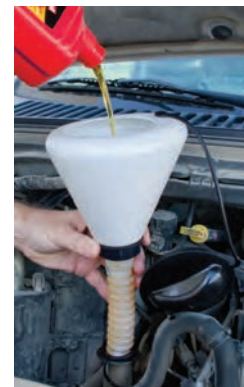

11102 8 GALLON OIL LIFT DRAIN

Quick Release Height Adjustment.

This specially shaped, translucent jug holds 8 gallons. Reinforced base will not warp with hot oil. Has a wide working range from 36-1/2" to 74". Its lower center of gravity increases stability and four 2-1/2" ball bearing wheels swivel and roll easily. Also has a heavy-duty adjustment clamp, large handle and big pour spout with threaded cap. Large 15" funnel has strainer built-in to catch drain plugs.

11102 8 Gallon Oil Lift Drain. Box. Shipping wt. 16 lbs.

11052 Spout Cap	11302 Funnel
11402 Top Tube, Plated	11502 Bottom Tube, Black
11512 Tube Lock Ring	11602 Wheel Assembly
11702 Tube Clamp	



QUICK RELEASE LOCK RING FOR FAST RAISING AND LOWERING OF UPPER TUBE

17432 18 GALLON OIL LIFT DRAIN

Quick Release Height Adjustment.

Translucent jug holds 18 gallons and will not warp with hot oil. Rolls easily with four heavy-duty 2-1/2" wheels. Metal tubes extend working area from 36-1/2" to 77". Drains from the bottom with a brass drain valve. Large 15" funnel has a built in strainer to catch drain plugs.

17432 18 Gallon Oil Lift Drain. Box. Shipping wt. 21 lbs.

11302 Funnel	11402 Top Tube, Plated
11502 Bottom Tube, Black	11512 Tube Lock Ring
11512 Tube Lock Ring	17382 Wheel
17402 Cap	17812 Brass Ball Valve



QUICK-RELEASE HEIGHT ADJUSTMENT

17132 55 GALLON DRUM FUNNEL KIT

15" Wide Funnel Fits into the Aluminum Adapter Which Fits Any 2" NPT Bung.

Kit comes with a splatter pad that has a porous material that allows fluid to quickly pass through into the drum. The pad material resists engine oil, transmission fluid, coolant, brake fluid, brake cleaner, gear oil and other solvents.

17132 55 Gallon Drum Funnel. Box. Shipping wt. 2 lb. 9 oz.

11302 Funnel
17122 Drum Adapter
38750 No Splatter Pad 15" Round



17912 55 GALLON DRUM DRAIN FUNNEL

Designed to Transfer Liquids into a 55 Gallon Drum.

The funnel drain sits on the top cover of 55 gallon drums. The funnel snout fits into the top bung hole for draining purposes. Four graduated circular indentations fit different oil filter sizes.

17912 55 Gallon Drum Drain Funnel. 8 per Master Pack. Shipping wt. 24 lbs. 12 oz.



19702 8 QT. OIL DISPENSER WITH LID

An Even Larger Size for Trucks, SUVs and Other Engines with Greater Oil Capacity.

A larger version of the 6 qt. Oil Dispenser with flexible pouring spout. Many large SUVs and trucks now require more than 6 quarts of oil. Translucent polyethylene material enables the user to read the oil level on the container up to 8 quarts. Marked in both quarts and liters. Flexible, removable 8" pouring spout. Lid may not fit older 19712 Dispensers.

19702 8 qt. Oil Dispenser. 4 per Master Pack. Shipping wt. 7 lbs. 8 oz.

19742 White Spout & Threaded Collar 19682 Lid

19692 Spout Cap 19792 Black Threaded Collar



17892 17902 TRANSMISSION DRAIN FUNNELS

Heavy-duty plastic lift drain funnels extend the catch area of any lift drain. The funnel catches any loose parts. Flexible, if run over it will return to its original shape. Super Transmission Drain Funnel fits the Ford E 40D and others. The fluted design can be used for draining oil filters. 17892 dimensions, 22" x 23". 17902 extra large size, 24" x 36".

17892 Transmission Drain Funnel. 12 per Master Pack. Shipping wt. 17 lbs. 4 oz.

17902 Super Transmission Drain Funnel. 6 per Master Pack. Wt. 28 lbs. 8 oz.



38750 38780 NO SPLATTER PAD

15" Diameter Pad & 22" Square Pad Protects Floors & Work Area from Messy Oil Splatter.

Insert 15" diameter pad in funnel or oil pan before oil change, or insert 22" square pad in transmission drain funnels or larger oil drain pans, before oil change to eliminate oil splatter. Porous material allows fluid to quickly pass through into funnel or pan. Pad material resists engine oil, transmission fluid, coolant, brake fluid, brake cleaner, gear oil and other solvents. 15" fits all standard oil lift drain funnels and oil pans. 22" fits all standard transmission drain funnels and larger size drain pans. Pad can be trimmed for perfect fit. Important: Not for coolants or fluids that will be recycled in the vehicle. Material fibers may contaminate the fluid.

38750 15" No Splatter Pad. 8 per Master Pack. Shipping wt. 8 oz.

38780 22" No Splatter Pad. 6 per Master Pack. Shipping wt. 1 lb. 6 oz.

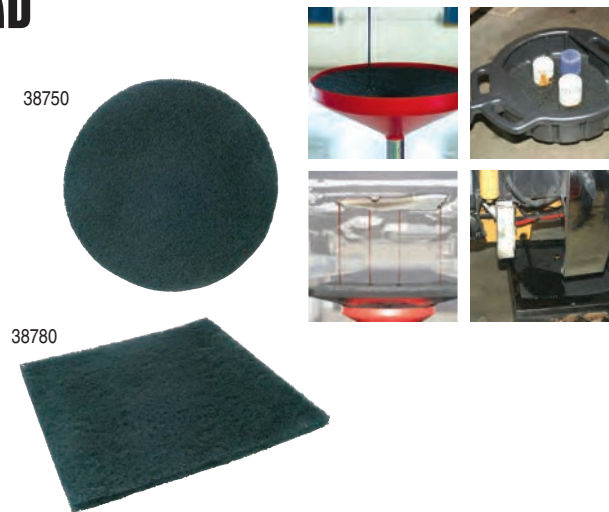

81450 ADAPT-A-CAP

Ideal for Servicing Hard-To-Reach Fluids in Automobiles, Motorcycles, Boats, RVs and Ag Equipment.

Eliminates the need for external pumps, hoses or funnels to transfer fluids. Helps prevent spills and messes. Three tapered urethane adapters to fit most standard quart and larger bottles, so the bottle becomes the pump. When the bottle is squeezed, internal bottle pressure forces the fluid up and out of the tube adapter. Includes three angled tubes, two extension tubes and two pick-up tubes.

81450 Adapt-A-Cap. Hang Card. Shipping wt. 5 oz.

81460 Tube Set 81540 Large Adapter

81550 Medium Adapter 81560 Small Adapter

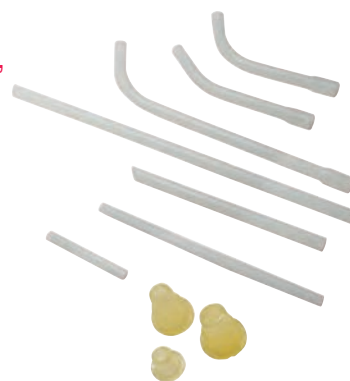

YouTube

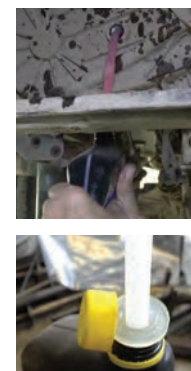

U.S. Pat No. 9,815,583

19732 19752 6 QUART OIL DISPENSERS

Translucent (see through) polyethylene material enables the user to read the liquid level on the container. Marked in both quarts and liters. The flexible 8" pouring spout enables easy transfer of liquid. The 19732 spout is white. The 19752 spout is red.

19732 6 Quart Oil Dispenser, White Spout. 6 per Master Pack. Shipping wt. 6 lbs. 14 oz.

19752 6 Quart Oil Dispenser, Red Spout. 6 per Master Pack. Shipping wt. 6 lbs. 14 oz.

19742 White Spout & Threaded Collar 19762 Red Spout & Threaded Collar

19792 Black Threaded Collar

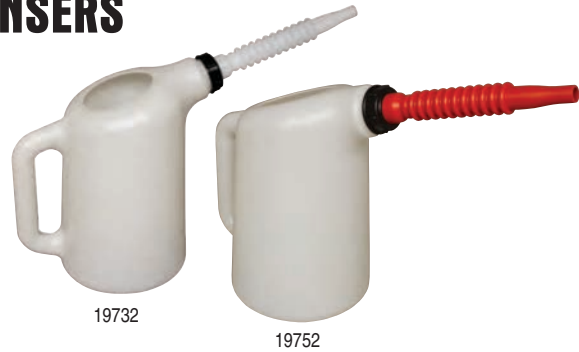

19732

19752

17972 17982 4.5 GALLON OVAL DRAIN PAN

New Drain Pan Design Provides 60% Larger Catch Area for Easier Fluid Draining.

Smooth pan design is easy to wipe out and clean. 6.25" pan height to fit tight spaces. 1.125" outer diameter spout for quick and easy pouring of used fluids into most jugs. The anti-splash lip helps prevent spilling when carrying or pouring. Multiple hand positions for carrying. Made of high-density polyethylene material that is resistant to chemicals and solvents. Two colors: 17972 is black for oil and 17982 is green for coolant.

17972 4.5 Gal Black Pan. 6 per Master Pack. Shipping wt. 12 lbs. 6 oz.

17982 4.5 Gal Green Pan. 6 per Master Pack. Shipping wt. 12 lbs. 6 oz.



17982

17972



SPOUT DESIGN FITS MOST JUGS

17932 6 QUART DRAIN PAN

Plastic Drain Pan with Pour Spout.

The pan is 4" deep, 14" wide to the spout.

17932 6 Quart Drain Pan. 50 per Master Pack. Shipping wt. 29 lbs. 6 oz.



19722 CATCH-ALL DRIP PAN

Ideal for Use on Showroom Floors, Garages, Carpets, or Under Equipment.

Made of durable polyethylene material to assure longevity and flexibility. Holds 8 quarts. Dimensions are 24" x 36" x 1-1/2".

19722 Catch-All Drip Pan. 12 per Master Pack. Shipping wt. 27 lbs.



19772 1 QUART SPRAY BOTTLE

Industrial Sprayer for Use with Light Oils, Solvents and Detergents.

The durable polyethylene bottle is impervious to high and low temperatures. The trigger mechanism is resistant to damage caused by caustic materials.

19772 1 Quart Spray Bottle. 1 per Pack. Shipping wt. 4 oz.

32 per Master Pack. Shipping wt. 10 lbs. 15 oz.



19852 TRUCK & TRAILER WHEEL PAN

Catches Oil from Wheel Hubs After Removing Cap.

Prevents oil mess during wheel repair. The pan fits rims with 13-3/4" ID and larger. Handle compartments hold hub nuts out of the oil. Made of polypropylene for durability. Will not warp if oil is warm. Capacity 88 ounces.

19852 Truck & Trailer Wheel Pan. 8 per Master Pack. Shipping wt. 5 lbs. 12 oz.



U.S. Pat No. 6,454,121

17922 MULTI-DRAIN TUB

30 Quart, Heavy-Duty, All-Purpose Plastic Drain Tub.

For draining radiators, crankcases, transmissions, differentials, etc. on cars and trucks. Designed for easy pouring and disposal. The apron facilitates washing and sorting parts. Dimensions 33" x 22" x 8".

17922 Multi-Drain Tub. 6 per Master Pack. Shipping wt. 27 lbs. 12 oz.



19822 TIRE / TUBE TEST TANK

A durable plastic tank for testing tubes and tires. The tank features reinforcement ribs for extra support. Will handle passenger tire sizes to wide oval and light duty truck tires. Inside dimensions 31" x 12" x 12".

19822 Tire / Tube Test Tank. 6 per Master Pack. Shipping wt. 44 lbs. 8 oz.



19202 LOW PROFILE TRUCK DRAIN WITH LID

For Large Capacity Crank Cases or Radiator Systems.

Overall height of 7-1/2" to fit under more aerodynamic trucks. The drain holds 60 quarts and is equipped with four rollers and a handle for transport and easy positioning under trucks. Cover and curved side design help keep oil from spilling during movement. Convenient handles and pour spout facilitate oil evacuation.

19202 Truck Drain with Lid. Box. Shipping wt. 26 lbs.

19192 Truck Drain Cover



68130 WHEEL WEIGHT TOOL

Removes, Trims and Installs Clip-on Wheel Weights.

Tire lever and offset flat tip for removing wheel covers. Use hammer head to pound on wheel weights. Pliers action grabs weights for removal. Also cuts weights. Sturdy vinyl grips provide a good grip.

68130 Wheel Weight Tool. Skin-Packed. Shipping wt. 1 lb. 3 oz.



22800 WHEEL STUD INSTALLER

Easily Installs New Wheel Studs.

Use with a ratchet or impact wrench to pull the new stud securely in place. Position the tool over the stud shaft. Tighten the lug nut against the tool to pull the stud in place. Works on most all automotive and light-duty truck wheel studs, foreign and domestic. NOTE: The bearing will wear with use and is not warranted.

22800 Wheel Stud Installer. Clam Shell. Shipping wt. 5 oz.

22820 Replacement Bearing & Dust Shield



U.S. Pat No. 7,421,769

28950 TRUCK WHEEL STUD INSTALLER

Installs Most Truck Wheel Studs in Seconds.

Use with an impact wrench or ratchet. The tool body is equipped with a thrust bearing to easily pull the new wheel stud into place. Fits truck wheel studs up to 22mm (7/8") in diameter. Use the lug nut to tighten against the tool body to pull the stud in position.

28950 Truck Wheel Stud Installer. Clam Shell. Shipping wt. 9 oz.

28970 Replacement Bearing and Dust Shield



U.S. Pat No. 7,421,769

14150 WHEEL STUD PILOT PIN MASTER SET

Easily Remove and Install Wheels on Vehicles with Lug Bolts.

Four pairs of Metric threaded wheel stud pilot pins allow you to hang the wheel without having to balance the wheel on the small lip of the hub. This helps prevent the wheel from falling and causing damage or injury. Set includes 2 each of 12mm x 1.25, 12mm x 1.5, 14mm x 1.25 and 14mm x 1.5 threaded pins.

14150 Wheel Stud Pilot Pin Master Set. Molded Case. Shipping wt. 2 lb. 6 oz.

13920 12mm x 1.5 Wheel Stud Pilot Pin

13930 14mm x 1.5 Wheel Stud Pilot Pin

13940 14mm x 1.25 Wheel Stud Pilot Pin

13990 12mm x 1.25 Wheel Stud Pilot Pin



YouTube



12mm x 1.25	2013 and newer Dodge Dart, 2012 and newer Fiat 500
12mm x 1.5	BMW, VW, Mercedes, Porsche, and Mini Cooper.
14mm x 1.25	2009 and newer BMW 6 series, 7 series, X3, X5, X6 and Mini Cooper.
14mm x 1.5	VW, Mercedes, Porsche, BMW and Audi.

13840 16MM X1.5 WHEEL STUD PILOT PINS

16mm x 1.5 Threads to Easily Remove and Install Wheels on Dodge ProMaster with Lug Bolts.

Wheel stud pilot pins allow you to hang the wheel without having to balance the wheel on the small lip of the hub. This helps prevent the wheel from falling and causing damage or injury. Simply insert threaded pins into hub bolt holes to hold the wheel in place while inserting or removing lugs. Fits 2014 and newer Dodge ProMaster with lug bolts.

13840 16mm x 1.5 Wheel Stud Pins, 2pc. Skin-Packed. Shipping wt. 8 oz.

13820 16mm x 1.5 Wheel Stud Pin, 1pc.



YouTube



19860 TIRE DEFLATOR SET FOR TPMS VALVE STEMS

Quickly Evacuates Air from Tires Without Removing the Valve Core.

Simply replace a standard sized valve cap with this handy tool and the special design will depress the pin in the valve core. Large openings on the sides of the tool allow air to escape quickly from the tire. Tools are marked so tires can be returned to their original position on the vehicle so TPMS will not need to be reset. Also saves time since the valve core has not been removed from the sensor.

19860 Tire Deflator Set for TPMS Valve Stems. Skin-Packed. Shipping wt. 5 oz.



14100 VALVE CORE TOOL

Removes and Installs Valve Cores and Valve Core Caps.

The double ended core driver reverses in the tool body. The reversible driver fits both large and small valve cores. Use the reverse end to remove and install valve core caps. The long tool handle will access inside dual wheels. The lightweight aluminum body is equipped with a pocket clip.

14100 Valve Core Tool. Skin-Packed. Shipping weight 1 oz.

14110 Core Driver

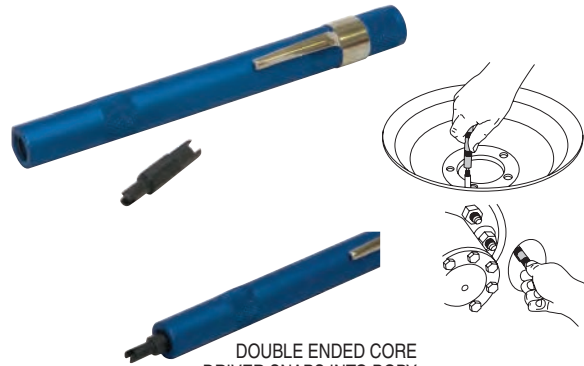

DOUBLE ENDED CORE DRIVER SNAPS INTO BODY

15190 VALVE CORE TOOL

Heat-Treated Steel Tip for Removing and Installing Standard Valve Cores.

A dual durometer handle for comfort with a rotating knob on the end allowing the tool to turn smoothly while applying pressure with the palm of your hand. The 5.7" long tool can reach valve stems on the inner dual wheels. Includes a handy pocket clip.

15190 Valve Core Tool. Skin-Packed. Shipping wt. 2 oz.



18810 VALVE CORE TORQUE TOOL

Properly Installs and Removes Valve Cores, Including Late Model Vehicles with the Tire Pressure Monitoring System (TPMS).

Torque tool is set to 4 inch pounds, to prevent under and over torquing the valve core. Helps prevent valve core leaks causing low tire pressure and possible TPMS alerts. Slim design allows access in tight spots.

18810 Valve Core Torque Tool. Skin-Packed. Shipping wt. 4 oz.

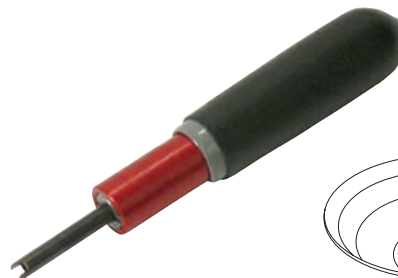

31310 DOUBLE FLARING TOOL SET

Makes Both Single and Double SAE Flares.

This tool set includes everything to flare thin wall steel, aluminum or .040 wall soft copper tubing. The set includes 5 thread dies and adapters for forming double flares on the following tubing sizes: 3/16", 1/4", 5/16", 3/8" and 1/2". However, this set is not for use on stainless steel tubing. Full instructions are included.

31310 Double Flaring Tool Set. Clam Shell. Shipping wt. 2 lbs. 1 oz.

31130 Long Bar	31180 3/8" Adapter
31370 3/16" Adapter	31380 1/4" Adapter
31390 5/16" Adapter	31410 1/2" Adapter

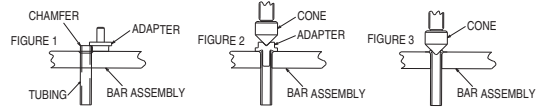

56150 COMBINATION FLARING TOOL

Works for Single and Double Flares, Also ISO (Bubble) Flares.

This set includes all the adapters and tools necessary for single and double flaring (standard and metric) plus the ISO (bubble) flare. Works on aluminum, copper and soft steel tubing. Not recommended for stainless steel. The set is packed in a plastic molded storage case with complete instructions.

56150 Combination Flaring Tool. Molded Case. Shipping wt. 3 lbs. 8 oz.



Part #	Description
31180	3/8" Adapter
31370	3/16" Adapter
31380	1/4" Adapter
31390	5/16" Adapter
31410	1/2" Adapter
56220	6mm Adapter
56240	10mm Adapter
56270	4.75mm ISO Adapter
56300	6mm ISO Adapter
56330	8mm ISO Adapter
56360	10mm ISO Adapter

44000 TUBING BENDER

Bends 4 Sizes.

Easy to use with one end connected - or can be mounted in a vise. Exclusive nylon form prevents kinking or flattening. For 3/16", 1/4", 5/16" and 3/8" O.D. tubing. Not recommended for 3/8" steel.

44000 Tubing Bender. Skin-Packed. Shipping wt. 15 oz.



44150 3/16" TUBING BENDER PLIERS

44070 1/4" TUBING BENDER PLIERS

Bends Brake Lines Without Kinking or Flattening, Especially in Tight Spots.

Bends all types of 3/16" and 1/4" OD tubing. Unique head design bends tubing without collapsing the tube. Won't mark tube surface. The handles are more than 3-1/4" apart for proper leverage when handling even steel tubing and unique head design on 44070 keeps handles in line with the tubing.

44070 1/4" Tubing Bender Pliers. Skin-Packed. Shipping wt. 10 oz.

44150 3/16" Tubing Bender Pliers. Skin-Packed. Shipping wt. 9 oz.

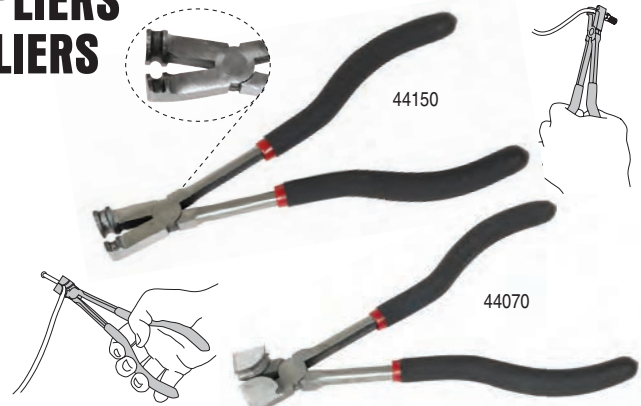

50000 MINI-CUTTER

Smooth Nylon Action Cuts Tubing Quickly.

Easy-to-use Mini-Cutter features all nylon construction, giving you smoother, easier operation & longer tool life. Used in tight places right on the car. For all types of metal tubing. Handles smallest tubing to 5/8" O.D. Completely non-corrosive.

50000 Mini-Cutter. Skin-Packed. Shipping wt. 2 oz. NSN 5110-00-965-0878

50050 Replacement Cutter



54810 HARMONIC BALANCER PULLER SET

Removes Most Automotive Harmonic Balancers.

The kit includes a standard harmonic balancer puller, pulling screws, adapters for 3300 and 3800 GM V6 engines, and a Harmonic Damper Pulley Puller for Chrysler, GM, Mitsubishi, & Dodge. Includes new interchangeable puller jaws for 3.6L V6 Chevrolet Camaro and Dodge 5.7L Hemi.

54810 Harmonic Balancer Puller Set. Molded Case. Shipping wt. 9 lbs.	
45230 Body	45310 Shoulder Bolt (3)
45320 Adapter	45540 M8 x 1.25 x 75 Bolt (3)
45590 3/8" - 16 x 3" Bolt (2)	45600 Washer (3)
45610 5/16" - 18 x 3" Bolt (3)	45620 M10 x 1.5 x 75 Bolt (3)
45640 3/8" - 24 x 3" Bolt (3)	46530 Tip
46550 Puller Screw	49550 5-3/8" Rod
49560 4" Rod	49590 Drive Screw
49630 7-3/8" Rod	51460 Harmonic Balancer S/A
51670 Magnetic Jaw Spacers (3)	51680 6-1/2" Rod
54790 Case for 54810	
54860 Harmonic Balancer Puller Jaw Set, Camaro	
54870 Harmonic Balancer Puller Jaw Set, Hemi	
54890 Crescent Shaped Washer, 12 pc.	

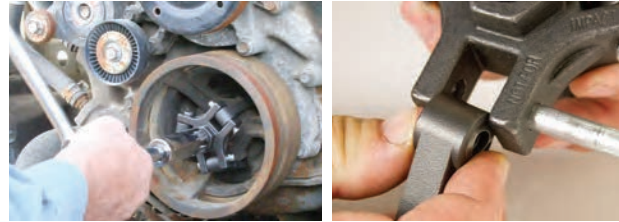

U.S. Pat No. 8,015,683

PULLERS

45500 HARMONIC BALANCER PULLER

Helps Stop Damage to Pulley and Shaft.

Designed to ease the operation of pulling the balancer pulley. It reduces damage to both the pulley and the shaft.

45500 Harmonic Balancer Puller. Clam Shell. Shipping wt. 3 lbs. 10 oz.

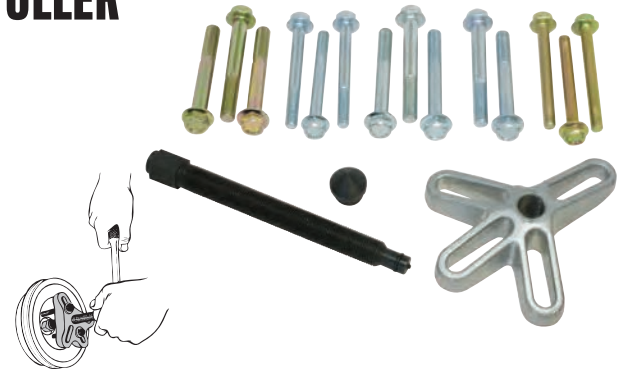

42890 42900 42910 U-JOINT PULLERS

Quickly and Easily Removes Sealed U-Joint Caps without Damage to Driveshafts, Yokes or Bearing Caps.

Three sizes to work on many cars, trucks and ag equipment. Heat-treated threads and casting for durability. 42890 works on cars, light-duty trucks and ag equipment with 1" to 1.25" bearing caps. 42900 works on cars, medium-duty trucks, ag equipment and light industrial vehicles with 1.25" to 1.7" bearing caps. 42910 works on Class 7 and 8 trucks with 1.5" to 2.2" bearing caps. Heat-treated threads and casting for durability.

42890 Small U-Joint Puller. Box. Shipping wt. 3 lbs. 4 oz.
42900 Medium U-Joint Puller. Box. Shipping wt. 4 lbs. 14 oz.
42910 U-Joint Puller, LG. Box. Shipping wt. 11 lbs. 9 oz.

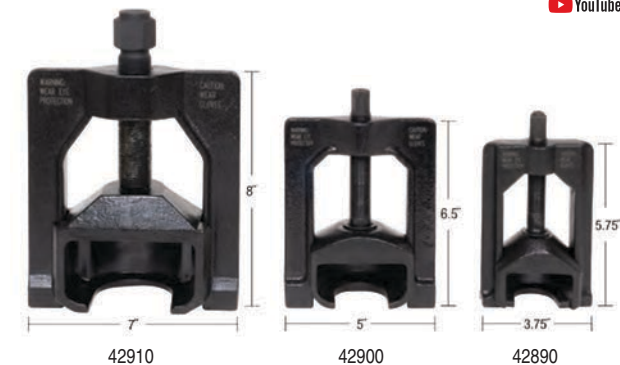

YouTube



51450 HARMONIC DAMPER PULLEY PULLER

For Chrysler, GM, Mitsubishi and Dodge.

Low profile design works in confined spaces eliminating the need to remove the radiator. Equipped with magnetic jaw spacers for 5.9 liter Dodge. New jaw geometry, slimmer magnetic spacers and a fourth rod allow use on 4.2L Trailblazer, Envoy and Bravada '03 and newer, 4.2L Buick Rainier '04 and newer, 3.5L Colorado and Canyon '04 and newer, Hummer H3 '06 and newer, 2.8L Colorado and Canyon '05 and newer. Jaws are now held in place with a clevis pin and can be removed and replaced easily.

51450 Harmonic Damper Pulley Puller. Clam Shell. Shipping wt. 2 lb. 11 oz.

49520 Clevis Pin

51640 Jaw

51670 Magnet and Housing Assembly

51680 6.5" Rod

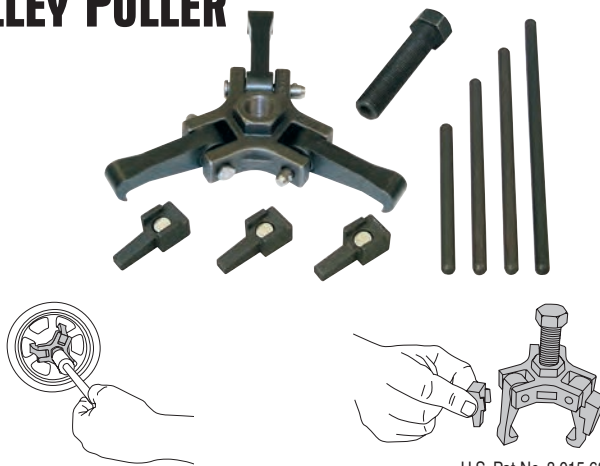

U.S. Pat No. 8,015,683

45300 HARMONIC BALANCER PULLER FOR GM

For GM 3300 And 3800 V6 Cylinder Engines.

The 45300 is equipped with the special bolts and adapters to pull the harmonic balancer cleanly without damage to the crank sensor. Order the 45350 Retrofit Kit to use with your Lisle 45500 Harmonic Balancer Puller.

45300 Harmonic Balancer Puller for GM. Boxed. Shipping wt. 2 lbs. 9 oz.

45350 Retrofit Kit for 45500. Mini Pouch. Shipping wt. 8 oz.

45310 Bolt (3)

45320 Adapter

45510 Body

45530 Center Screw



Order 45350 Retrofit Kit to update the Lisle 45500. Contains Adapter and 3 Shoulder Bolts.



39000 "NO SLIP" PULLEY PULLER/INSTALLER

Removes and Installs Pressed on Power Steering, Alternator and Air Pump Pulleys.

Makes removing pressed on pulleys an easy job. The unique puller body completely houses the pulley hub to prevent slipping on even the tightest pulleys. Fits most domestic models including GM 3.1 and Quad 4 engines. Works on traditional V shaped pulleys and serpentine belt system pulleys. Also works faster than other conventional pulley pullers. Patented design traps the pulley and provides a gripping handle. Tool comes with detailed instructions and a heavy-duty plastic storage case.

39000 "No Slip" Pulley Puller/Installer. Molded Case. Shipping wt. 2 lbs. 2 oz.

38910 Short 3/8"x16 Install. Adapter

38920 Short 8mm Install. Adapter

38930 Med. 3/8"x16 Install. Adapter

38940 Short Pin

38950 Long Pin

38960 Long 3/8"x16 Install. Adapter

38990 Puller Screw

39010 Small Jaw

39020 Large Jaw

39030 Handle

39040 Washer

39050 Nut

39070 Pusher Shaft

40060 Bearing



CUT-AWAY VIEW



U.S. Pat No. 7,007,359

57340 STEERING WHEEL LOCK PLATE TOOL

Fits Domestic Lock Plates, Including Tilt and Telescoping.

Tool depresses lock plate for easy removal of lock ring. Allows access to steering column for repair work. Comes with standard and metric adapters, plus two puller frames. Fits most domestic lock plates, including tilt and telescoping columns. Works on vehicles with air bags.

57340 Steering Wheel Lock Plate Tool. Skin-Packed. Shipping wt. 1 lb. 8 oz.

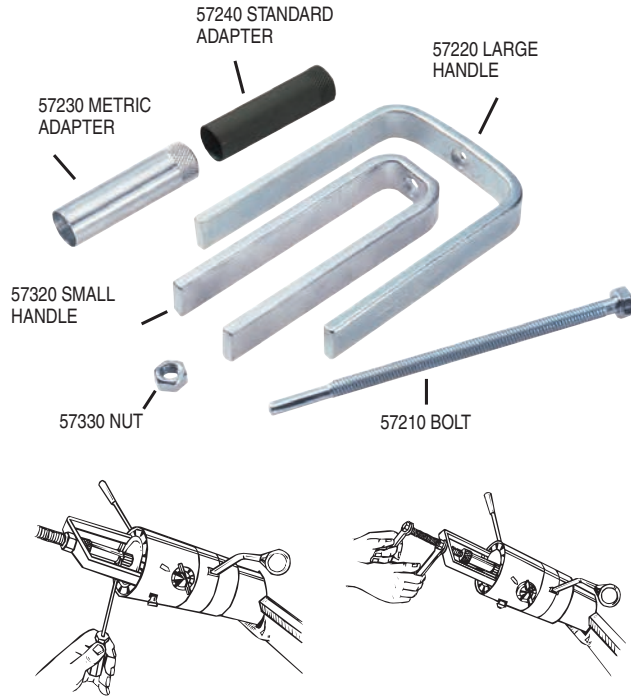

45000 STEERING WHEEL PULLER

Universal Puller for Most Makes & Models.

Screw pad protects end of steering shaft. Heavy duty for long wear.

45000 Steering Wheel Puller. Clam Shell. Shipping wt. 1 lb. 10 oz.

45050 Screw Pad

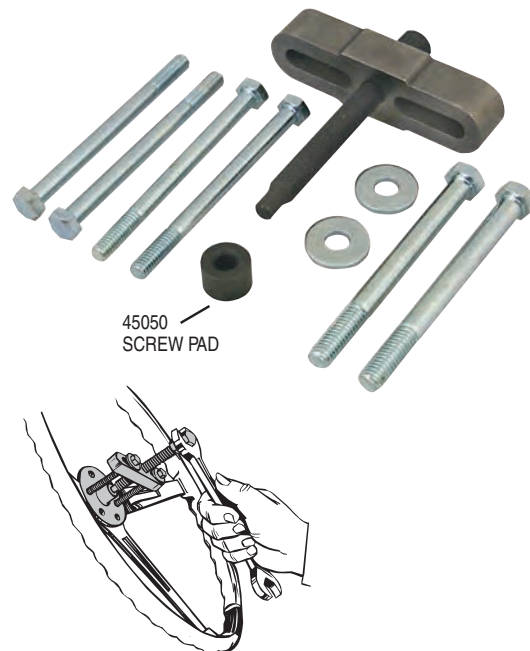

19940 PIVOT PIN REMOVER

Removes the pivot pin on GM, Ford and Chrysler tilt and telescoping Saginaw steering columns. Includes an extra screw.

19940 Pivot Pin Remover. Skin-Packed. Shipping wt. 2 oz.

19970 Cap Screw

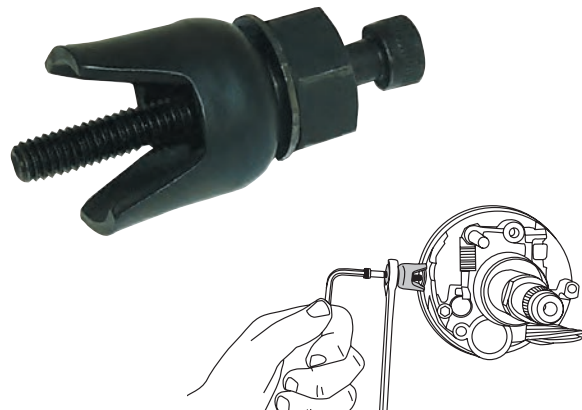

39850 MASTER PLUS DISCONNECT SET

A Set of the Most Popular Disconnect Tools in One Handy Molded Case.

Includes fuel line quick connect and spring lock couplings, air conditioning line couplings and transmission oil cooler connectors. All disconnect tools are also available individually.

39850 Master Plus Disconnect Set. Molded Case. Shipping wt. 3 lbs. 4 oz.

11750 Clutch Coupling Remover for Ford

22930 Low Profile 3/8" Jiffy-tite® Disc. 22940 Low Profile 1/2" Jiffy-tite® Disc.

34750 Low Profile Fuel Line Disc. Set 37000 AC/Fuel Line Disc. Set

37300 Fuel & AC Disconnect Pliers 37500 Fuel Module Disc. Tool for GM

39160 Fuel Line Retaining Clip Tool Set

39210 Main Fuel Line Disc. for Toyota & Nissan

39400 Angled Disconnect Set

39660 Trans. Oil Cooler Line Scissors 3/8" x 1/2"

39810 Hydraulic Clutch Line Disc. for GM

39820 Coupler Disc. for Chrysler 39830 Oil Cooler Line Disc. for Ford

39840 Fuel Line Disc. for Ford 39930 5/16" x 3/8" Scissor Disc.

39940 Coupler Disconnect



39900 MASTER DISCONNECT SET

Contains 8 Popular Disconnect Tools for A/C & Fuel Lines.

A complete set of disconnect tools that can be stored in a handy blow-molded case. All disconnect tools are also available individually.

39900 Master Disconnect Set. Molded Case. Shipping wt. 3 lbs. 13 oz.

35000 Flex Fuel Disconnect for GM

37000 AC/Fuel Line Disconnect Set

37500 Fuel Line Quick Disconnect for GM

39400 Angled AC/Fuel Line Disc. Set

39930 5/16" & 3/8" Scissor Disconnect

39940 Coupler Disconnect

39960 Ford Transmission Line Disconnect



37300 FUEL AND AC DISCONNECT PLIERS

Unique Design Provides Extra Leverage When Disconnecting Quick Connect Coupling Air Conditioning and Fuel Lines.

Use with 5/16", 3/8" or 1/2" adapters from the Lisle 37000 or 39400 Disconnect Tool Sets. The forks have different sized openings so the tool can be turned around to fit single or two step collar designed connector lines. The pliers can also be used to reconnect stubborn lines or connections that are in hard-to-reach areas.

37300 Fuel and AC Disconnect Pliers. Skin-Packed. Shipping wt. 9 oz.



YouTube



39160 FUEL LINE RETAINING CLIP TOOL SET

Compact Tool Design Fits Tight Spaces.

Two sizes, 3/8" and 5/16" are designed to release the nylon retaining clip used on the fuel lines of newer GM and Chrysler vehicles with in tank electric fuel pumps. Includes bead chain for storage.

39160 Fuel Line Retaining Clip Tool Set. Skin-Packed. Shipping wt. 1 oz.

39170 5/16" Disconnect Tool

39180 3/8" Disconnect Tool

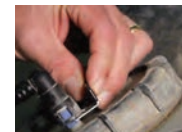

YouTube

37000 AIR CONDITIONING / FUEL LINE DISCONNECT TOOL SET

Disconnects Air Conditioning and Quick Connect Fuel Lines.

Set disconnects the spring lock couplings on Ford & Chrysler air conditioning lines. Works on fuel line quick connect couplings found on GM, Ford, & Chrysler. The 5/16" size fits on push lock connectors on Ford radiators and transmission lines. Set includes six sizes: 5/16", 3/8", 1/2", 5/8", 3/4" and 7/8".

37000 Air Conditioning / Fuel Line Dis. Tool Set. Skin-Packed. Shipping wt. 4 oz.

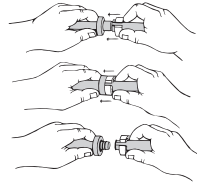

PART#	SIZE
37010	7/8"
37020	3/4"
37030	5/8"
37040	1/2"
37050	3/8"
37060	5/16"



39400 ANGLED DISCONNECT TOOL SET

Disconnects Air Conditioning and Quick Connect Fuel Lines.

Disconnects spring lock couplings on Ford and Chrysler AC lines. Works on fuel lines and other quick disconnect couplings on domestic and import vehicles. The handles are angled to access tight spots. Made of durable plastic that resists fuels and solvents. Six sizes: 5/16", 3/8", 1/2", 5/8", 3/4" and 7/8". Available individually Skin-Packed.

39400 Angled Disconnect Tool Set. Skin-Packed. Shipping wt. 4 oz.

PART#	SIZE
39410	5/16"
39420	3/8"
39430	1/2"
39440	5/8"
39450	3/4"
39460	7/8"

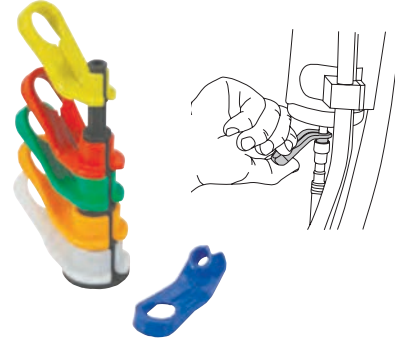

35800 ALUMINUM DISCONNECT SET, 6PC.

Durable Aluminum Disconnects Work on Air Conditioning Lines and Quick Connect Fuel Lines.

Disconnect spring lock couplings on Ford and Chrysler air conditioning lines. Also works on fuel line quick connect couplings on GM, Ford, and Chrysler. Easy to use in confined spaces. Set includes six sizes: 5/16", 3/8", 1/2", 5/8", 3/4" and 7/8".

35800 Aluminum Disconnect Set. Molded Case. Shipping wt. 10 oz.

35740 5/16" Disconnect tool	35750 3/8" Disconnect tool
35760 1/2" Disconnect tool	35770 5/8" Disconnect tool
35780 7/8" Disconnect tool	35790 Case for 35800
39190 3/4" Disconnect tool	



35740 - 5/16"

35750 - 3/8"

35760 - 1/2"

35770 - 5/8"

39190 - 3/4"

35780 - 7/8"

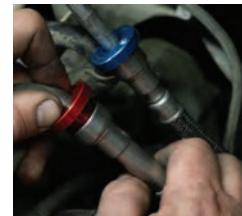

FUEL MANAGEMENT

37500 FUEL MODULE DISCONNECT TOOL FOR GM

Disconnects the Fuel Module on 98 & Later GM Full Size Pickups, Suburban & Tahoe.

Two piece design allows access to the connectors. Slide the proper size end into the connector. Rotate and slide the other half in place. Now the module can be disconnected. Fits both 3/8" and 5/16" connector sizes. Will fit all other 3/8" and 5/16" applications. Clip together for convenient storage.

37500 Fuel Module Disconnect Tool for GM. Skin-Packed. Shipping wt. 1 oz..

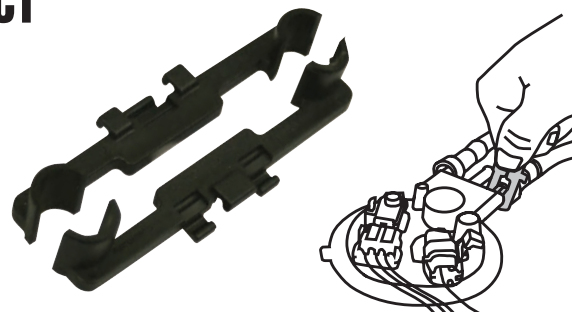

39210 MAIN FUEL LINE DISCONNECT FOR TOYOTA AND NISSAN

Disconnects the 5/16" Main Fuel Line from the Fuel Rail on Many Toyota and Nissan Vehicles.

Hinged design and fully tapered end allow tool to be quickly and easily inserted into fuel line quick connector, even in hard-to-reach areas. Works on Toyota Echo, Scion xB, xA, TC, Solara, Corolla, Sequoia, Celica, RAV 4, Prius, Camry, MR2, Matrix, Tundra and Highlander. Also for 2004 and newer Nissan models with a 5/16" fuel rail.

39210 Main Fuel Line Disc. for Toyota and Nissan. Skin-Packed. Shipping wt. 2 oz.

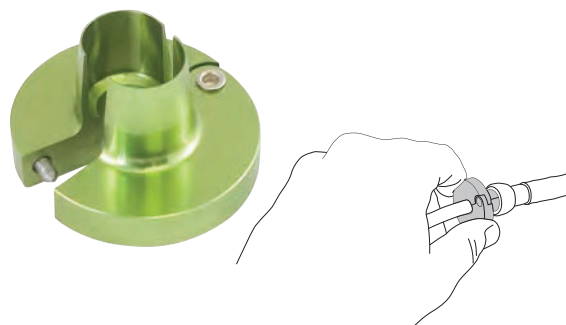

63800 SPRING LOCK COUPLER DISCONNECT SET, 7PC.

Set of Seven Disconnect Tools for Spring Lock Connectors on A/C and Fuel Lines Found on Many Chrysler and Ford Vehicles.

The tools are color coded for sizing and spring loaded to remain on the A/C or fuel line.

63800 Spring Lock Disc Set, 7pc. Hang Card. Shipping wt. 4 oz.

63740 Spring Lock 3/8" Red

63750 Spring Lock 3/8" Yellow

63760 Spring Lock 1/2" Blue

63770 Spring Lock 1/2" Green

63780 Spring Lock 5/8" Shrt Black

63790 Spring Lock 5/8" Long Black

63810 Spring Lock 3/4" White



63730 SCISSOR DISC AC / FUEL LINE SPRING LOCK

Releases Four Sizes of Spring Lock Couplings on A/C and Fuel Lines.

The tool fits four spring lock sizes: A-3/4", B-5/8", C-1/2", and D-3/8" found on many Chrysler and Ford vehicles.

63730 Scissor Disc Tool 4 Size. Skin-Packed. Shipping wt. 4 oz.



63710 63720 SCISSOR DISCONNECTS LOW PROFILE

Low Profile, Double-Ended Tools Disconnect Fuel Lines on Many Chrysler, Ford, and GM Vehicles.

The 1/2" side on the 63710 is especially useful for removing the fuel supply line from the sending unit on 2001 and newer Chevrolet/GMC 3/4-ton and 1-ton trucks equipped with 6.6L Duramax engine. The 3/8" side of the 63720 is especially useful for removing the fuel supply line from the center port of the sending unit on 2000 and newer Chevrolet/GMC Suburban and Tahoe/Yukon. Also 1999 and newer Chevrolet Silverado pickups equipped with gas engines.

63710 Scissor LP 3/8" x 1/2". Skin-Packed. Shipping wt. 2 oz.

63720 Scissor LP 5/16" x 3/8". Skin-Packed. Shipping wt. 2 oz.



37160 DISCONNECT PLIERS

Disconnects Fuel Line and EVAP Line Fittings with Tabs that Must be Depressed to Disengage.

Low-profile design with 85° bend allows the tool to fit between the top of the fuel tank and vehicle. Works great on Delphi two tab connectors and some import vehicles. Can also be used on some electrical connectors. Spring action makes tool easier to use.

37160 Disconnect Pliers. Skin-Packed. Shipping wt. 7 oz.



U.S. Pat No. D811,841

37140 DISCONNECT PLIERS, 45°

The Low Profile Design with 45° Bend Disconnects Fuel Line, EVAP Line Fittings and DEF Fittings in Hard-to-Reach Areas.

Disconnects fuel line, EVAP line and DEF fittings with tabs that must be depressed to disengage. Low-profile design with 45° bend allows the tool to fit between the top of the fuel tank and vehicle. Works great on Delphi two tab connectors and some import vehicles. Can also be used on some electrical connectors.

37140 Disconnect Pliers, 45 Degree. Skin-Packed. Shipping wt. 8 oz.



U.S. Pat No. D811,841

34750 LOW PROFILE FUEL LINE DISCONNECT SET

Disconnects the Quick Connect Fuel Lines in Hard-to-Reach Locations.

3/8" adapters work on 5.3 liter Suburban, Tahoe, Yukon, Avalanche and select Silverados, Sierras and other GM fuel lines. 5/16" adapters work on Ford and Chrysler applications.

34750 Low Profile Fuel Line Disconnect Set. Skin-Packed. Shipping wt. 5 oz.

34740 5/16" Adapter Set

34810 Handle

34830 3/8" Adapter Set

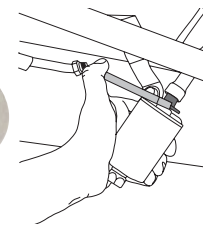

U.S. Pat No. 7,404,245

35000 FUEL FILTER DISCONNECT FOR GM

Disconnects the fuel line from the fuel filter on 5.3L Suburban, Tahoe, Yukon, Avalanche and select Silverados and Sierras. Insert the two semicircular disconnects into the coupling. Connect the handle and depress to separate the fuel line from the filter.

35000 Fuel Filter Disconnect for GM. Skin-Packed. Shipping wt. 2 oz.

34810 Handle

34830 3/8" Adapter Set

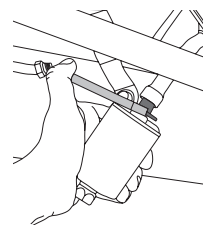

U.S. Pat No. 7,404,245

63000 FUEL TANK LOCK RING TOOL

A Rugged Tool To Remove and Install Plastic Fuel Tank Lock Rings from 4" to 7-1/4" Without Damage.

Channel Design on body allows the legs to adjust to fit a wide range of applications and keeps the drive centered. Works on the new smaller GM serrated rings and traditional rings. The design is compact so the tool is not left hanging over the work area with the potential for hitting other components.

63000 Fuel Tank Lock Ring Tool. Skin-Packed. Shipping wt. 1 lbs. 6 oz.



YouTube

62970 FUEL TANK LOCK RING KIT

A Stout Tool to Remove and Install Fuel Tank Lock Rings without Damage.

New leg set works on many 2004 and newer vehicles including Ford F150, Chevrolet pickups, Chrysler/Dodge mini vans, PT Cruiser, Dakota and Durango. Channel design on body allows 2 interchangeable sets of legs to adjust to fit rings from 4" to 7-1/4" and keeps the drive centered. Works on the smaller GM serrated rings and traditional rings. Design is compact so the tool is not left hanging over the work area with the potential of hitting other components.

62970 Fuel Tank Lock Ring Kit. Box. Shipping wt. 2 lb. 2 oz.

62980 Lock Ring Leg, 1 Tab

62990 Lock Ring Leg, 2 Tab

63020 Lock Ring Leg



YouTube

27800 UNIVERSAL NOID LIGHT

Adjustable Probes fit all Electronic Fuel Injection Systems.

Versatile tool tests throttle body injectors, ported fuel injectors and sequential central port injectors. One-person operation. Attach tool to the car body or windshield with suction cup. View the Noid Light from the front seat while cranking the ignition. A flashing light indicates normal pulses. No light or constant light indicates a problem. Two probe adapters screw on to form larger diameter probes.

27800 Universal Noid Light. Clam Shell. Shipping wt. 7 oz.

27790 Probe Adapter

27870 Bulb

27890 Wire Assembly

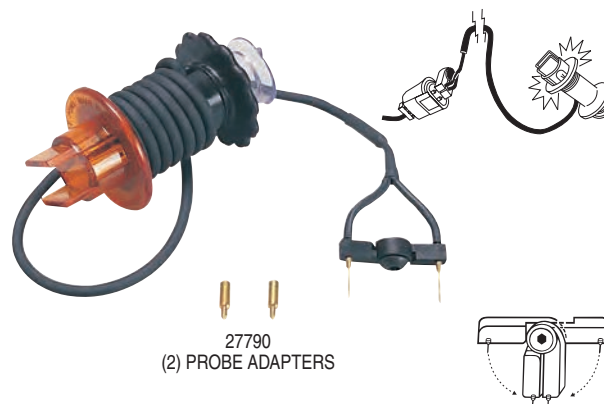

27790
(2) PROBE ADAPTERS

55700 MASTER FUEL INJECTION TEST SET

Test All Types of Fuel Injection Systems.

Checks fuel pressure on most Port Fuel Injection (PFI) and Throttle Body Injection (TBI) systems. Comes with adapters & gauges for checking many types of systems. Adapts to work with test port, end of hose & in-line connections. Tests GM, Ford, Chrysler, Honda/Acura, Toyota, Bosch CIS & L-Jetronic.

55700 Master Fuel Injection Test Set. Plastic Case. Shipping wt. 10 lbs.



22990 4 PC. LOW PROFILE JIFFY-TITE® DISCONNECT SET

Low Profile Design Quickly and Easily Disengages the Line from Jiffy-tite Quick-Connect Fittings without Removal of the Clip.

The teeth of the tool fit perfectly into the tight tolerance of Jiffy-tite® connectors and when rotated allow the line to be pulled without damage to the connector or retaining clip so they can be reused. Includes four sizes: 3/8", 1/2", 5/8"-30% and 5/8"-39%. All sizes are available individually.

22990 4 Pc. Low Profile Jiffy-tite® Disconnect Set. Molded Case. Shipping wt. 9 oz.

22930 Low Profile 3/8" Jiffy-tite® Disconnect

22940 Low Profile 1/2" Jiffy-tite® Disconnect

22950 Low Profile 5/8"-30% Jiffy-tite® Disconnect

22960 Low Profile 5/8"-39% Jiffy-tite® Disconnect

22970 Low Profile 3/4" Jiffy-tite® Disconnect (available individually)



22930 3/8" JIFFY-TITE® DISCONNECT

Low-Profile Design Quickly and Easily Disengages Jiffy-tite Quick-Connect Fittings Without Removal of the Clip.

Teeth of the tool fit perfectly into tight tolerance of Jiffy-tite® connectors and when rotated allow the line to be pulled without damage to the connector or retaining clip so they can be reused. 22930 fits the most popular Jiffy-tite® fittings used in newer GM vehicles, many newer Daimler Chrysler and some newer Mercedes vehicles.

22930 3/8" Jiffy-tite® Disconnect. Skin-Packed. Shipping wt. 3 oz.

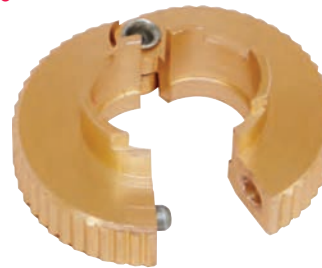

22710 DISCONNECT SET FOR JIFFY-TITE® CONNECTORS

Disengages the Line from Jiffy-tite Quick-Connect Fittings Without Removal of the Clip.

Handy spring-action of the stainless steel tool keeps the tool on the line. Teeth of the tool fit perfectly into tight tolerance of Jiffy-tite® connectors so they can be reused.

22710 Disconnect Set For Jiffy-tite® Connectors. Skin-Packed. Shipping wt. 12 oz.

22720 3/8" Jiffy-tite® Disconnect

22730 1/2" Jiffy-tite® Disconnect

22740 5/8" 39% Jiffy-tite® Disconnect

22750 5/8" 30% Jiffy-tite® Disconnect

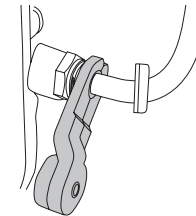

Applications:

1996 and newer GM vehicles
Many 2004 and newer Daimler Chrysler vehicles
Some 2005 and newer Mercedes vehicles
Harley-Davidson V-Rod
Freightliner, Peterbilt, Volvo and White

55600 CLUTCH PILOT BUSHING REMOVER

Uses Hydraulic Pressure to Remove Bushings.

Screw the self-tapping tip 2-3 threads into the brass or bronze bushing. Then pump out the bushing with a grease gun. Fits bushings from 1/2" to 3/4" I.D. Not for use on steel bearings. Made of case hardened steel.

55600 Clutch Pilot Bushing Remover. Skin-Packed. Shipping wt. 4 oz.

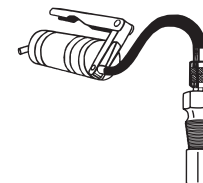

39960 TRANSMISSION OIL COOLER LINE DISCONNECT FOR FORD

Two Sizes, 3/8" and 1/2" are Designed to Disconnect Transmission Cooler Lines.

Use 3/8" size for '03 - '10 Ford V8 Explorer, '04 and later Ford F150 and Cadillac CS. Use 1/2" size for Ford Super Duty Trucks, F250, F350 and F450. Simply push the line toward the connector, then engage tool and pull line from connector.

39960 Trans. Oil Cooler Line Disconnect for Ford. Skin-Packed. Shipping wt. 1 oz.

39910 1/2" Disconnect

39920 3/8" Disconnect

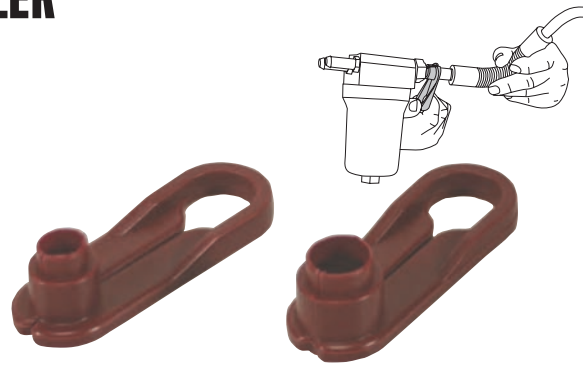

U.S. Pat No. 7,350,282

39660 TRANSMISSION OIL COOLER LINE SCISSORS 3/8" X 1/2"

Stepped Design with Two Sizes to Work on Ford and Cadillac Vehicles.

Similar in function to our 39960 plastic model but made from metal and in a scissor design.

39660 Transmission Oil Cooler Line Scissors 3/8" x 1/2". Skin-Packed. Shipping wt. 3 oz.

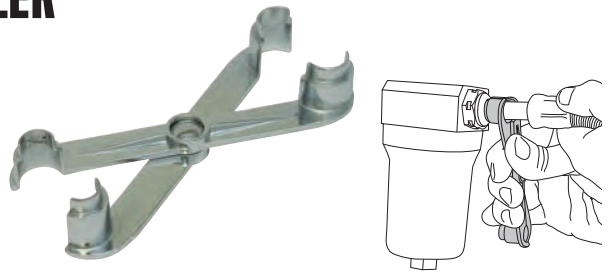

39220 TRANSMISSION OIL COOLER DISCONNECT SET FOR FORD

Two Sizes, 3/8" and 1/2" are Made of Aluminum for Durability.

Use 3/8" size for 2003 and later Ford V8 Explorer, 2004 and later Ford F150 and Cadillac CS. Use 1/2" size for Ford Super Duty trucks, F250, F350 and F450.

39220 Transmission Oil Cooler Disconnect Set for Ford. Skin-Packed Card. Shipping wt. 1 oz.

39230 Ford Oil Cooler Disconnect 3/8"

39240 Ford Oil Cooler Disconnect 1/2"



23400 TRANSMISSION/TRANSAXLE PLUGS

Stops Loss of Transmission Fluid.

Stepped plugs fit transmissions and transaxles on most cars and pickups. Stepped design prevents slipping.

Plugs cover a range of 1" - 2.180" (25.4mm - 55.37mm).

23400 Transmission Plugs. Clam Shell. Shipping wt. 11 oz.

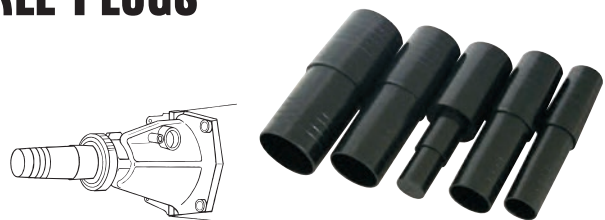

55500 CLUTCH ALIGNMENT TOOL

Faster, Easier Replacement of Clutches.

55500 shaft and bushings provide an accurate fit for eight pilot bearing sizes. Tapered cone handles the rest.

55500 Clutch Alignment Tool. Clam Shell. Shipping wt. 1 lb. 3 oz.

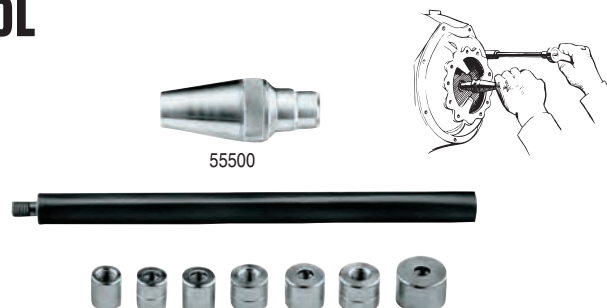

57010 57020 57030 57040

SWIVEL-GRIPPER™

"NO-SLIP" FILTER WRENCH

Tough, Stainless Steel Band with Permanently Bonded Textured Coating for Superior Gripping Power...won't Slip.

Swivel handle makes it easy to turn in tight spots. Handle swivels more than 180° with adjustable tension. Tension adjusting nut allows swivel pressure to be regulated — no more floppy filter wrenches. Patented coating process adds many additional gripping points to securely grab the filter. Extra Small Swivel-Gripper has a special narrow 1/2" band to fit into tight places. Can also be used on some fuel filters. Large Swivel-Gripper fits many tractors and other farm implement products.

57010 Extra Small Swivel-Gripper. Range 2.375" - 2.625" (60.3 - 66.7mm).
Skin-Packed. Shipping wt. 12 oz.

57020 Small Swivel-Gripper. Range 2.875" - 3.25" (73 - 82.5mm).
Skin-Packed. Shipping wt. 12 oz.

57030 Standard Swivel-Gripper. Range 3.5" - 3.875" (88.9 - 98.4mm).
Skin-Packed. Shipping wt. 13 oz.

57040 Large Swivel-Gripper. Range 4.125" - 4.5" (104.7 - 114.3mm).
Skin-Packed. Shipping wt. 13 oz.



Gripping Texture

Swivels More Than 180°

Tension Adjusting Nut

U.S. Pat No. 8,573,094

FILTER

57050 57060 57070

SWIVEL-GRIPPER™

"NO-SLIP" FILTER WRENCHES

For Cummins & Detroit Diesel, John Deere and Caterpillar Tough, Stainless Steel Band with Permanently Bonded Textured Coating for Superior Gripping Power... Won't Slip.

For Cummins & Detroit Diesel, John Deere and Caterpillar engines. "Swivel Grip" handle makes it easy to turn in tight spots. Handle made of tubular steel for increased strength.

57050 "No-Slip" Filter Wrench for Cummins & Detroit Diesel, Range 4-5/16" - 4-3/4" (109.5mm - 120.7mm). Skin-Packed. Shipping wt. 13 oz.

57060 "No-Slip" Filter Wrench for John Deere, Range 4-3/4" - 5-3/16" (120.7 - 131.8mm).
Skin-Packed. Shipping wt. 13 oz.

57070 "No-Slip" Filter Wrench for Caterpillar, Range 5-1/4" - 5-3/4" (133.5 - 146mm).
Skin-Packed. Shipping wt. 13 oz.



U.S. Pat No. 8,573,094

57160 SWIVEL-GRIPPER™ 9 PACK

A Handy Merchandiser that Comes with Nine Swivel-Gripper "No-Slip" Filter Wrenches.

Allows users to feel the texture coating on the inside of the wrench band. Individual Swivel-Gripper filter wrenches can be ordered to refill the display as needed. All four wrench sizes are included.

57160 Swivel Gripper 9 Pack. Box. Shipping wt. 6 lbs. 3 oz.



Contents:

- 2 - 57010 Import "No Slip" Filter Wrench 2.375" - 2.625" (60.3 - 66.7MM)
- 2 - 57020 Small "No Slip" Filter Wrench 2.875" - 3.25" (73 - 82.5MM)
- 3 - 57030 Standard "No Slip" Filter Wrench 3.5" - 3.875" (88.9 - 98.4MM)
- 2 - 57040 Large "No Slip" Filter Wrench 4.125" - 4.5" (104.7 - 114.3MM)

U.S. Pat No. 8,573,094

53200 53250 53500 53700 54200 54300 54400 "SWIVEL GRIP" OIL FILTER WRENCHES

Handle Swivels to Clear Obstructions.

All models feature the swivel handle, gripper "teeth" and 1" wide stainless steel band. The swivel handle makes it easy to turn filters in hard to reach locations. Vinyl covered handle.

53200 John Deere Oil Filter Wrench. Range 4.75" - 5.1875" (120.7 - 131.8mm). Skin-Packed. Shipping wt. 14 oz.

53250 Large Swivel Grip Oil Filter Wrench. Range 4.125" - 4.5" (104.7 - 114.3mm). Skin-Packed. Shipping wt. 12 oz.

53500 Standard Swivel Grip Oil Filter Wrench. Range 3.5" - 3.875" (88.9 - 98.4mm). Skin-Packed. Shipping wt. 12 oz. NSN 5120-00-228-6287

53700 Small Swivel Grip Oil Filter Wrench. Range 2.875" - 3.25" (73 - 82.5mm). Skin-Packed. Shipping wt. 12 oz.

54200 Oil Filter Wrench for Cummins & Detroit Diesel Engines. Range 4.3125" - 4.75" (109.5 -120.7mm). Skin-Packed. Shipping wt. 13 oz.

54300 Oil Filter Wrench for Caterpillar Engines. Range 5.25" - 5.75" (133.5 - 146mm). Skin-Packed. Shipping wt. 14 oz.

54400 Swivel Grip Oil/Fuel Filter Wrench. Range 2.375" - 2.625" (60.3 - 66.7mm). Skin-Packed. Shipping wt. 11 oz.



Swivel Action
53250, 53500, 53700



Square Handles on
53200, 54200, 54300

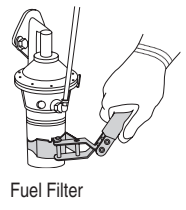

54400 Has Special
Narrow 1" Band

53900 FILTER WRENCH

Straight Handle Filter Wrench.

1" stainless steel band with special "teeth" grips tightly. Vinyl-covered handle provides firm, comfortable grip.

53900 Filter Wrench. Range 3-1/2" to 3-7/8" (88.9 - 98.4mm). Skin-Packed. Wt. 11 oz

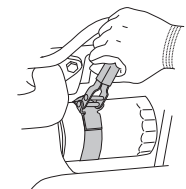

61450 10 PC. HEAVY DUTY END CAP FILTER WRENCH SET 61460 21 PC. HEAVY DUTY END CAP FILTER WRENCH MASTER SET

Heavy Duty Design with a Welded Steel Plate for Strength.

Two collections of end cap filter wrenches to fit the most popular domestic and import vehicles.

61450 10 pc. Heavy Duty End Cap Filter Wrench Set.
Molded Case. Shipping wt. 4 lbs. 15 oz.

61460 21 pc. Heavy Duty End Cap Filter Wrench Master Set.
Molded Case. Shipping wt. 7 lbs. 12 oz.

61390 84mm-14 flutes - NEW	61470 74mm-15 flutes - NEW
61480 76mm-15 flutes - NEW	61490 90mm-15 flutes - NEW
61510 93mm-45 flutes	61520 73/74mm-14 flutes
61530 82mm-15 flutes	* 61540 65/67mm-14 flutes
* 61550 80mm-15 flutes	* 61560 74/76mm-15 flutes
* 61570 76mm-14 flutes	* 61580 93mm-15 flutes
* 61590 93mm-36 flutes	* 61600 65mm-14 flutes
61610 86mm-14 flutes	61620 88.4mm-15 flutes
61630 96mm-18 flutes	61640 68mm-14 flutes
61650 76mm-30 flutes	61660 86mm-16 flutes
61670 100mm-15 flutes	61880 Case for 61460

*Available hang tag packaged for display. Others are available Mini Pouch.



61450 Includes:

61540	61550	61560
61570	61580	61590
61600	61640	61650
61660		

61460 Includes:

61390	61470	61480
61490	61510	61520
61530	61540	61550
61560	61570	61580
61590	61600	61610
61620	61630	61640
61650	61660	61670

Supersedes 61500



SECURE WELDS ON
STEEL PLATE

FILTER

50750 50950 OIL FILTER PLIERS

Two Position, Slip Joint Handle for Greater Range.
50750 Range from 2-1/4" to 4". 50950 Range from 3-5/8" to 6".

Sure grip teeth prevent slipping. Cushioned handles provide comfort.

50750 Oil Filter Pliers. Skin-Packed. Shipping wt. 1 lb. 5 oz.

50950 Truck and Tractor Oil Filter Pliers. Skin-Packed. Shipping wt. 1 lb. 13 oz.

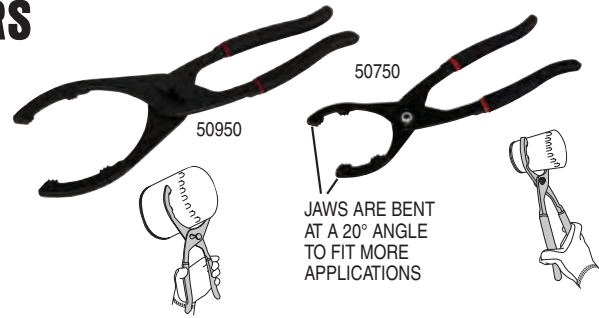

YouTube

63830 63850 63890 3 JAW WRENCH W/ ADAPTER

Heat-Treated Arms with Specially Designed Gripping Jaws Grab Even the Most Stubborn Filters.

Removable adapter provides lower clearance in tight spots. Use with 3/8" or 1/2" square drive. Can also use with 21mm wrench or socket.

63830 61-124mm 3 Jaw Wrench w/ Adapter. Box. Shipping wt. 1 lb.

63850 58-110mm 3 Jaw Wrench w/ Adapter. Box. Shipping wt. 1 lb.

63890 73-153mm 3 Jaw Wrench w/ Adapter. Box. Shipping wt. 1 lb. 6 oz.

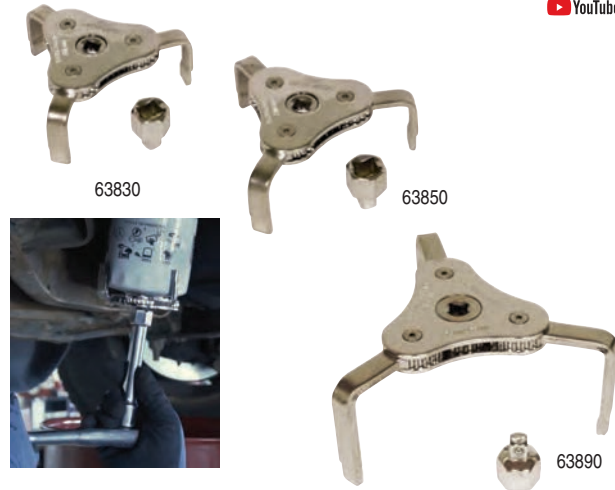

FILTER

61390 61470 61480 61490 HEAVY DUTY END CAP FILTER WRENCHES

Hardened Steel Plates are Wire and Spot Welded for Strength.

Four new sizes to fit even more domestic and import vehicles.

61390 H.D. End Cap Wrench 84mm-14 flutes. Mini Pouch. Shipping wt. 6 oz.

61470 H.D. End Cap Wrench 74mm-15 flutes. Mini Pouch. Shipping wt. 6 oz.

61480 H.D. End Cap Wrench 76mm-15 flutes. Mini Pouch. Shipping wt. 6 oz.

61490 H.D. End Cap Wrench 90mm-15 flutes. Mini Pouch. Shipping wt. 7 oz.



61150 FUEL FILTER WRENCH FOR RAM ECODIESEL

Fuel Filter Wrench for the 2014-current Ram 1500 EcoDiesel.

Wrench is designed with four tabs that line up on the outside of fuel filter housing. Filter wrench is made of cast aluminum with a 3/8" square drive and 7/8" hex drive.

61150 Fuel Filter Wrench for Ram 3.0L EcoDiesel V6. Box. Shipping wt. 6 oz.



63250 63600 FILTER WRENCHES

63250 Range from 3-1/8" to 3-7/8".

63600 Range from 2-1/2" to 3-1/8".

Steel jaws grip filter without slipping. Works in tight spots from the front of the filter using 3/8" drive.

63250 Wide Range Filter Wrench. Skin-Packed. Shipping wt. 14 oz.

63600 Import Car Filter Wrench. Skin-Packed. Shipping wt. 14 oz.

63630 Replacement Spring

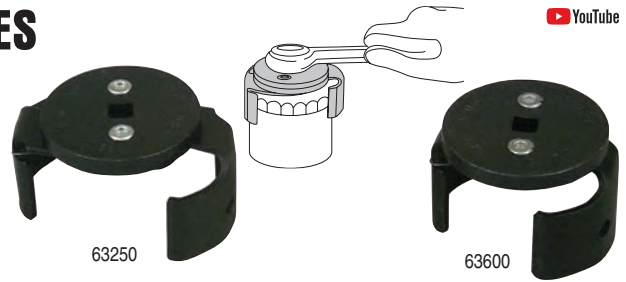

YouTube

61040 65MM 14 FLUTE END CAP WRENCH FOR TOYOTA

Super Strong, Forged Wrench Allows Easy Removal on All 65mm 14 Flute Toyota and Lexus Cartridge Oil Filters.

On 6 and 8 cylinder engines, the wrench engages the ribs and flutes on the filter cap housing. Forged steel with a bright chrome plated finish. Use with 3/8" square drive or 1-1/16" wrench.

61040 65mm 14 Flute End Cap Wrench for Toyota. Box. Shipping wt. 15 oz.

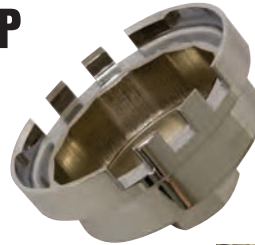

Wrench engages the ribs and flutes on the filter cap housing.

61160 65MM 14 FLUTE END CAP WRENCH FOR TOYOTA 4 CYLINDER

Allows for Easy Removal of 4 Cylinder Toyota, Lexus and Scion Cartridge Oil Filters.

65mm with 14 flutes. Securely engages the ribs and flutes. Forged steel with a bright chrome plated finish. Use with 3/8" square drive or 1-1/16" wrench.

61160 65mm 14 Flute End Cap Wrench for Toyota 4 Cyl. Box. Shipping wt. 15 oz.



YouTube

60200 HEAVY DUTY STRAP FILTER WRENCH

A Heavy-Duty Heat Treated Alloy Steel Yoke and Strong Web Strap.

Use with 1/2" drive to remove or install filters and other objects up to 6-1/2" in diameter. 3-5/8" long yoke fits into tight areas.

60200 Heavy Duty Strap Filter Wrench. Skin-Packed. Shipping wt. 8 oz.



YouTube

63500 "BIG RANGE" FILTER WRENCH

For Filters Up to 6" (152.4mm).

Adjusts quickly to fit any spin-on oil filter up to 6" diameter. Use with 1/2" drive or 3/4" wrench. Strong polypropylene belt.

63500 Big Range Filter Wrench. Skin-Packed. Shipping wt. 10 oz.



53400 UNIVERSAL 3" OIL FILTER WRENCH

Remove and Install All 3" Filters.

Works in the tightest spots. Stainless steel band, gripper teeth...won't slip. 3/8" square drive.

53400 Universal 3" Oil Filter Wrench. Skin-Packed. Shipping wt. 8 oz.

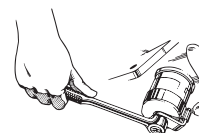

40600 OFFSET FILTER WRENCH SET, 7PC.

Low Profile, 6 Point Wrench with Offset 3/8" Square Drive for Clearance in Hard-to-Reach Spaces.

Use on oil and fuel filter canisters when replacing the element. Size is laser marked on each wrench with a blow-molded case for storage.

- 40610 - 24mm for Cadillac and some BMW
- 40620 - 25mm for Fleetguard Filter on Motorhomes, Buses, and Some Medium Size Trucks with Cummins Engine. Also Some K&N Filters
- 40630 - 27mm for 2003 and later Mercedes 1.8L, Smart and some VW
- 40640 - 28mm for 2010-2018, 6.7L Dodge Cummins Fuel Filter Canister
- 40650 - 29mm (1-1/8") for Dodge Cummins Fuel Filter Housing
- 40660 - 32mm (1-1/4") for GM Ecotec, 2.0L, 2.2L and 2.4L Four Cylinder Oil Filter Housing; Some Saturn & Saab
- 40670 - 36mm for Ford 6.0L Diesel Fuel and Oil Filter Housings, Mini Cooper and some BMW Oil Filter Housings, and Mack Truck Oil Filter Housing

40600 Offset Filter Wrench Set, 7 Pc. Molded Case. Shipping wt. 1 lb. 1 oz.

40610 Offset Filter Wrench 24mm 40620 Offset Filter Wrench 25mm

40630 Offset Filter Wrench 27mm 40640 Offset Filter Wrench 28mm

40650 Offset Filter Wrench 29mm 40660 Offset Filter Wrench 32mm

40670 Offset Filter Wrench 36mm 40680 Case for 40600



13300 5 PC. FILTER SOCKET SET

Set of 5 Low Profile Oil and Fuel Filter Canister Sockets in One Handy Case.

Contains very low profile, 6 point 24mm, 27mm, 29mm, 32mm and 35/36mm sockets for use on oil and fuel filter canisters when replacing the element. Use with 3/8" drive.

13300 5 Pc. Filter Socket Set. Molded Case. Shipping wt. 1 lb. 13 oz.

13310 24mm Socket 13320 27mm Socket

14500 35/36mm Socket 14600 29mm Socket

14700 32mm Socket

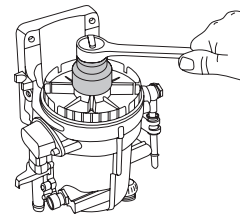
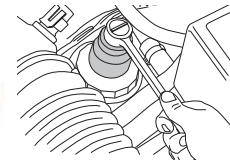

53100 ADJUSTABLE OIL FILTER WRENCH

For Trucks and Tractors. Fits John Deere, Case, Caterpillar, Mack, Detroit Diesel and Others.

Tough, stainless steel band adjusts for extra range...won't slip. Professional quality. 1/2" square drive. Range 4-3/8" - 5-5/8" (111.1 - 142.8mm).

53100 Adjustable Oil Filter Wrench. Skin-Packed. Shipping wt. 14 oz.

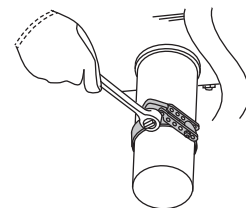

13270 LOW PRO FILTER SOCKET SET, 7PC.

Contains 7 of the Most Popular Size Filter Canister Sockets to Work on Many Applications.

Contains very low profile, 6 point 24mm, 25mm, 27mm, 28mm, 29mm, 32mm and 36mm sockets for use on oil and fuel filter canisters when replacing the element. Use with 3/8" drive. Set includes:

- 13280 - 25mm for Fleetguard Filter on Motorhomes, Buses, and Some Medium Size Trucks with Cummins Engine. Also Some K&N Filters
- 13290 - 28mm for 2010-2018, 6.7L Dodge Cummins Fuel Filter Canister
- 13310 - 24mm for Cadillac and some BMW
- 13320 - 27mm for 2003 and later Mercedes 1.8L, Smart and some VW
- 14500 - 36mm for Ford 6.0L Diesel Fuel and Oil Filter Housings, Mini Cooper and some BMW Oil Filter Housings, and Mack Truck Oil Filter Housing
- 14600 - 29mm (1-1/8") for Dodge Cummins Fuel Filter Housing
- 14700 - 32mm (1-1/4") for GM Ecotec, 2.0L, 2.2L and 2.4L Four Cylinder Oil Filter Housing; Some Saturn & Saab

13270 Filter Socket Set 7pc. Molded Case. Shipping wt. 2 lb. 4 oz.

13310 24mm Socket 13280 25mm Socket

13320 27mm Socket 13290 28mm Socket

14600 29mm Socket 14700 32mm Socket

14500 36mm Socket



57180 OIL FILTER PLUG FOR CUMMINS

Used to Plug the Oil Filter When Changing Oil on 2013-2017 Dodge Ram Cummins 2500/3500 Heavy-Duty Trucks.

Threads into the filter for a secure seal so the filter can be removed from the tight space without spilling oil. T-handle makes removal and installation easier. The tool also allows the technician to pre-lube the filter before installation.

57180 Oil Filter Plug for Cummins. Skin-Packed. Shipping wt. 2 oz.



YouTube

57170 FUEL FILTER PLUG FOR DURAMAX

Used to Plug the Fuel Filter When Changing Filter on 2004-2016 Chevy Duramax Trucks.

Threads into the filter for a secure seal so the fuel filter can be removed from the tight space without spilling. T-handle makes removal and installation easier. Made of glass filled nylon for strength.

57170 Fuel Filter Plug for Duramax. Hang Card. Shipping wt. 4 oz.



YouTube

58850 OIL PAN PLUG RETHREADING KIT

Removes Damaged Thread and Taps a New Oversize Thread.

This set includes a piloted drill, spring-loaded tapping tool and 5 magnetic drain plugs. The unique tapping tool ensures the new thread will be perpendicular to the gasket surface to prevent leakage. Works on soft steel and aluminum oil pans with 1/2", 12mm & 14mm threads. Can be used on the vehicle when room permits.

58850 Oil Pan Plug Rethreading Kit. Molded Case. Shipping wt. 2 lb. 1 oz.

58650 Plugs & Gaskets (Set of 5)

58880 Piloted Drill Assembly

58900 Tap



DRILLING DRAIN HOLE



TAPPING DRAIN HOLE

FILTER

51150 PLASTIC OIL DRAIN PLUG SET, 3 PC.



Safely and Easily Remove Plastic Oil Pan Drain Plugs Found on Many Late Model Audi, BMW, Ford and Volkswagen without Damage to the Plug.

Offset design of the Ford tool to keep technicians hands away from hot fluids. Spring loaded tab securely holds plug keeping it from dropping into the drain pan. The two bits have a 3/8" square drive.

51150 Plastic Oil Drain Plug Set, 3 pc. Skin-Packed. Shipping wt. 10 oz.

51160 BMW Plastic Plug Bit

51170 VW/Audi Plastic Plug Bit

51180 Ford Plastic Plug Wrench



BMW



VW/Audi



Ford

50210 GASKET SEPARATOR

For Use On Any Application with a Gasket Seal such as Oil Pans, Transmission Pans and Differential Covers.

Drive tool between the gasket and then use a hammer from the side to separate the pan from the gasket. Blade is made from hardened carbon steel. Replacement blade available separately.

50210 Gasket Separator. Skin-Packed. Shipping wt. 8 oz.

50210 Replacement Blade

50210 Button Head Cap Screw

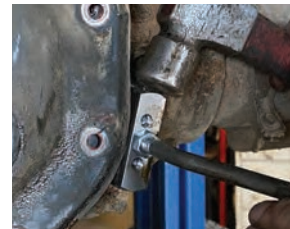

SCRAPER

51350 PUTTY KNIFE

1-1/4" Stiff, Tempered Steel Blade.

Ideal for scraping old putty, paint, dirt & carbon. Can also be used for applying putty. One piece blade has a satin finish. Handle is made of polypropylene for easy cleanup.

51350 1-1/4" Putty Knife. Skin-Packed. Shipping wt. 3 oz.



81780 5/8" & 1-1/4" CARBIDE SCRAPER SET

Designed To Remove Gasket Residue from Steel and Aluminum Heads and Manifolds, Along with Carbon Build-Up and Even Rust.

Can be used to clean disc brake caliper slides. Tungsten carbide tips are brazed to the steel blade that is molded into the comfortable 6" long handle. Two blade widths, 1-1/4" and 5/8" to work on many applications. Tips remain very sharp and are precision ground. Also available individually.

81780 5/8" & 1-1/4" Carbide Scraper Set. Skin-Packed. Shipping wt. 2 lbs.

81760 Carbide Scraper 1-1/4"

81770 Carbide Scraper 5/8"



YouTube

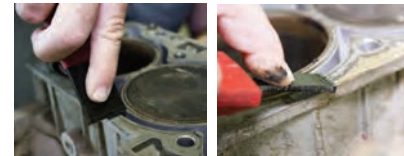

81810 5/8" CARBIDE SCRAPER, 5"

The Carbide Scraper Features a Shorter and Narrower Double-Dip Grip Handle.

Designed to remove gasket residue from steel and aluminum heads and manifolds, along with carbon build-up and even rust. Can be used to clean disc brake caliper slides. The tungsten carbide tip is brazed to the 5" long steel blade. The tip remains very sharp and is precision ground. Use caution when using scraper on aluminum to avoid scratching the surface.

81810 5/8" Carbide Scraper. Skin-Packed. Shipping wt. 3 oz.



YouTube



81960 5/8" CARBIDE SCRAPER, 8"

The Carbide Scraper Features a Narrow Double Dip Grip Handle.

Designed to remove gasket residue from steel and aluminum heads and manifolds, along with carbon build-up and even rust. Can be used to clean disc brake caliper slides. The Tungsten carbide tip is brazed to the 8" steel blade. The tip remains very sharp and is precision ground. Use caution when using scraper on aluminum to avoid scratching the surface.

81960 5/8" Carbide Scraper, 8". Skin-Packed. Shipping wt. 5 oz.



YouTube



81990 1-1/4" CARBIDE SCRAPER, 8"

Designed to Remove Gasket Residue from Steel and Aluminum Heads and Manifolds, Along with Carbon Build-Up and Even Rust.

The carbide scraper features a double-dip grip handle for comfort. Can be used to clean disc brake caliper slides. The Tungsten carbide tip is brazed to the steel blade. The tip remains very sharp and is precision ground. Use caution when using scraper on aluminum to avoid scratching the surface.

81990 1-1/4" Carbide Scraper, 8". Skin-Packed. Shipping wt. 7 oz.



52000 RAZOR BLADE SCRAPER

Designed to Reach Tight Places.

Comes with five carbon steel blades for removing stickers from windshields, bumpers, etc. Also comes with a plastic blade for use on safety plastic laminated windshields to prevent scratching. Spring-release allows easy interchange of blades. Reverse blade in holder for storage. Hollow handle stores all blades when not in use.

52000 Razor Blade Scraper. Skin-Packed. Shipping wt. 7 oz.

51320 Replacement Blades. 5 piece set carbon steel blades.

52080 Replacement Blades. 5 piece set plastic blades.

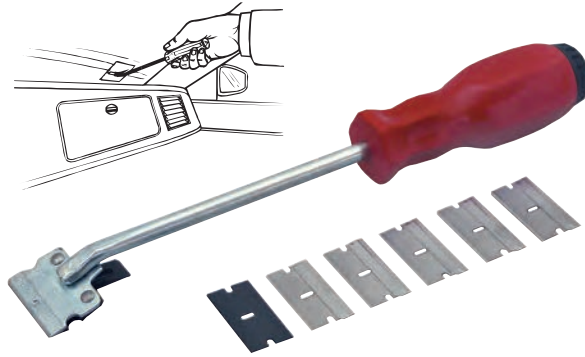

52150 100 PACK OF RAZOR BLADES

Convenient Pack of Standard Razor Blades.

Contains 100 carbon steel, single edged razor blades. Pack is resealable for storage. Fits all standard razor blade tools, including Lisle 52000 Razor Blade Scraper.

52150 100 Pack of Razor Blades. Clam Shell. Shipping wt. 12 oz.



52400 FOLD-UP SCRAPER

Blade Folds into the Handle for Safe, Convenient Storage.

The fold-up scraper features three arm positions and a slanted blade for proper scraping. Great for removing decals, bumper stickers, labels, etc. The quick change blade holder firmly holds a single edge razor blade. Includes 1 single edge razor blade. Overall length 7-3/4".

52400 Fold-Up Scraper. Skin-Packed. Shipping weight 4 oz.

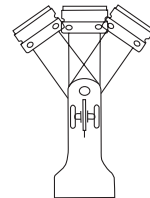

LOCKS IN THREE DIFFERENT POSITIONS

51000 HEAVY DUTY SCRAPER

Sharp Steel Blade Quickly Peels Off Carbon, Sludge.

Sharp, hardened steel blades remove carbon, old gasket material, adhesives, sludge and other hard-to-clean substances from blocks, heads, etc. Comes with three blades. 1", 1-1/2" and 2" widths. Tool will hold single edge razor blade for bumper stickers and decals.

51000 Heavy Duty Scraper. Skin-Packed. Shipping wt. 7 oz.

Replacement Blades	
Part No.	Size
51120	Six 1" blades
51130	Six 1-1/2" blades
51140	Six 2" blades

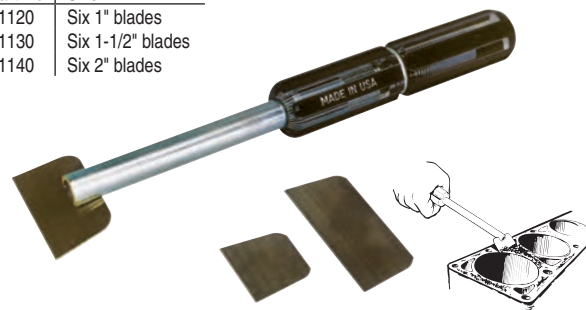

52460 RAZOR BLADE SCRAPER

Strong, Solid Handle Ideal for Stripping Paint, Caulk, Labels, Overspray, Gasket Material, Urethane and Glue.

No sharpening needed, just replace the blade. Protective cover keeps blade sharp and prevents cuts. Includes one standard single edge blade.

52460 Razor Blade Scraper. Skin-Packed. Shipping wt. 3 oz.



13600 33850 HEX BIT SETS

Seven Piece Sets. 3/8" Square Drive.

High strength, heat-treated alloy steel bits are securely broached into chrome plated sockets. No set screws to tighten! Bit sets store in a convenient vinyl holder.

13600 Hex Bit Set. Skin-Packed. Shipping wt. 10 oz.

33850 Metric Hex Bit Set. Skin-Packed. Shipping wt. 11 oz.

All bits are available individually Skin-Packed.



Part No.	Size
13610	1/8"
13620	5/32"
13630	3/16"
13640	7/32"
13650	1/4"
13660	5/16"
13670	3/8"

Part No.	Size
33860	3mm
33870	4mm
33880	5mm
33890	6mm
33900	7mm
33910	8mm
33920	10mm

42150 42300 HEX KEY SETS

In a Handy Storage Case.

42150 Standard Set includes 12 heat-treated alloy steel hex keys. 42300 Metric Set includes 9 heat-treated alloy hex keys. Also available individually.

42150 Standard Hex Key Set. Skin-Packed. Shipping wt. 7 oz.

42300 Metric Hex Key Set. Skin-Packed. Shipping wt. 10 oz.

Part No.	Wrench Size
42160	.05"
42170	1/16"
42180	5/64"
42190	3/32"
42200	7/64"
42210	1/8"
42220	9/64"
42230	5/32"
42240	3/16"
42250	7/32"
42260	1/4"
42270	5/16"

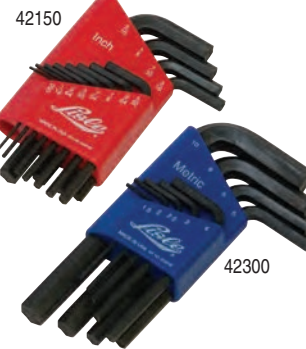

Part No.	Wrench Size
42310	1.5mm
42320	2mm
42330	2.5mm
42340	3mm
42350	4mm
42360	5mm
42370	6mm
42380	8mm
42390	10mm

42500 42650 LONG ARM HEX KEY SETS

In a Handy Storage Case.

Allows for longer reach for deep socket Allen-type screws. Also increases torque. 42500 includes 12 fractional hex keys. 42650 includes 9 metric hex keys. Heat-treated alloy steel. Also available individually.

42500 Standard Long Arm Hex Key Set. Skin-Packed. Shipping wt. 10 oz.

42650 Metric Long Arm Hex Key Set. Skin-Packed. Shipping wt. 13 oz.

Part No.	Wrench Size
42520	5/16"
42530	1/4"
42540	7/32"
42550	3/16"
42560	5/32"
42570	9/64"
42580	1/8"
42590	7/64"
42600	3/32"
42610	5/64"
42620	1/16"
42630	.05"



Part No.	Wrench Size
42660	10mm
42670	8mm
42680	6mm
42690	5mm
42700	4mm
42710	3mm
42720	2.5mm
42730	2mm
42740	1.5mm

82400 MORTORQ® SUPER SOCKET SET, 5PC.

For Removing and Installing MORTORQ® Fasteners Found on Chrysler, GM, Jeep and Other Models.

The fasteners are used in a variety of applications including bell housings, interior components, door frames, body components and more. Sockets are made of heat-treated alloy steel. Includes sizes MTS-0, MTS-1, MTS-2, MTS-3 and MTS-4. Use with 3/8" square drive. Includes vinyl holder for storage.

82400 MORTORQ® Super Socket Set, 5pc. Skin-Packed. Shipping wt. 10 oz.

82410 #0 Socket	82420 #1 Socket
82430 #2 Socket	82440 #3 Socket
82450 #4 Socket	



60850 MASTER TRIPLE SQUARE BIT SET

Nine Piece Triple Square (12 point) Bits to Fit 4, 5, 6, 8, 10, 12, 14, 16 and 18mm Sizes.

For head bolts, brake caliper bolts, door handle screws, axle bolts and other applications. The 4 and 5mm bits have 5/16" hex drive. The 6, 8, 10 and 12mm bits have 1/2" hex drive. The 14 and 16mm bits have 5/8" hex drive. The 18mm bit has a 3/4" hex drive. The three largest sizes are designed to work on tamper-proof applications.

60850 Master Triple Square Bit Set Skin-Packed. Shipping wt. 15 oz.

60710 4mm Triple Square Bit	60720 5mm Triple Square Bit
60760 6mm Triple Square Bit	60770 8mm Triple Square Bit
60780 10mm Triple Square Bit	60790 12mm Triple Square Bit
60860 14mm Triple Square Bit	60870 16mm Triple Square Bit
60880 18mm Triple Square Bit	

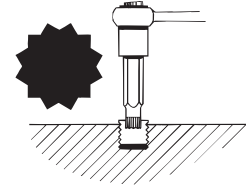

ALL BITS ARE ALSO AVAILABLE INDIVIDUALLY

60750 12 POINT BIT SET

Triple Square (12 point) Bits to Fit 6, 8, 10 and 12mm Sizes; all on 1/2" Hex Drives.

Fits some head bolts, retaining bolts, disc brake calipers and other applications.

60750 12 Point Bit Set. Skin-Packed. Shipping wt. 10 oz.

60760 6mm 12 Point Bit	60770 8mm 12 Point Bit
60780 10mm 12 Point Bit	60790 12mm 12 Point Bit

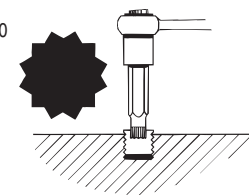

ALL BITS ARE ALSO AVAILABLE INDIVIDUALLY Skin-Packed

62900 SUPER OUT SET

A SUPER STRONG Extractor Set Made of a Special Hardened, Shock-Resistant Tool Steel.

Works on both left and right hand threads. Super Outs cut their way STRAIGHT into bolts, eliminating wedging or further tightening of frozen bolts and screws. Five extractor sizes extract 1/4" to 1/2" and larger bolts and screws. All bits available individually Skin-Packed.

62900 Super Out Extractor Set. Skin-Packed. Shipping wt. 4 oz.

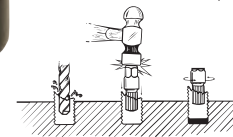

Part No.	Bolt Size	Drive Size
62560	1/4"	1/8"
62570	5/16"	11/64"
62730	3/8"	15/64"
62580	7/16"	9/32"
62590	1/2"	3/8"

61980 STRIPPED SCREW EXTRACTOR SET, 10PC.

Six Lobed Spiral Bits are Designed to Remove Rounded or Stripped Fasteners with Internal Drive Heads.

Ten sizes of extractors fit Torx® and Torx Plus® sizes T-10 to T-55; internal hex sizes 7/64" to 3/8" and 3mm to 10mm. Will also work on other internal drive screw heads. To remove broken bolts, drill a pilot hole for the appropriate size extractor. Choose the extractor that fits snugly in the fastener. Turn counter-clockwise to remove fastener. It may be necessary in some applications to drive the extractor into the fastener with a hammer for maximum torque.

61980 Stripped Screw Extractor Set, 10pc. Skin-Packed. Shipping wt. 9 oz.

62010 #1 Stripped Screw Extractor	62020 #2 Stripped Screw Extractor
62030 #3 Stripped Screw Extractor	62040 #4 Stripped Screw Extractor
62050 #5 Stripped Screw Extractor	62060 #6 Stripped Screw Extractor
62070 #7 Stripped Screw Extractor	62080 #8 Stripped Screw Extractor
62090 #9 Stripped Screw Extractor	62100 #10 Stripped Screw Extractor



EXTRACTOR	TORX®/TORX PLUS®	INTERNAL HEX	DRILL SIZE
#1	T/TP-10	7/64" (3MM)	7/64
#2	T/TP-15	9/64"	9/64
#3	T/TP-20	5/32" (4MM)	5/32
#4	T/TP-25-27		3/16
#5	T/TP-30	3/16"	13/64
#6	T/TP-40	5MM	15/64
#7	T/TP-40	1/4" (6MM)	17/64
#8	T/TP-45	5/16" (8MM)	21/64
#9	T/TP-50	3/8"	3/8
#10	T/TP-55	10MM	29/64

U.S. Pat No. 8,448,547

29200 30200 HAND IMPACT TOOL SETS

Loosens Rusted, Frozen Nuts, Bolts and Screws.

Unique design delivers over 200 ft. lbs. of "Shock Torque". Can be reversed to tighten. Can also be used with impact sockets!

29200 3/8" Impact Tool Set. 3/8" sq. drive with 3/8" drive bit holder; #1, #2, #3, #4 Phillips, and 3/8" straight slot bits. Shipping wt. 2 lbs. 10 oz. NSN 5120-01-072-2956

30200 1/2" Impact Tool Set. 1/2" sq. drive with 1/2" drive bit holder; #1, #2, #3, #4 Phillips, and 3/8" straight slot bits. Shipping wt. 2 lbs. 10 oz. NSN 5120-01-072-2956



30200 IMPACT SET INCLUDES:

Part No.	Tool
30000	1/2" Impact Tool
30150	1/2" Bit Holder
29630	#1 Phillips Bit
30180	#2 Phillips Bit
29550	#3 Phillips Bit
30190	#4 Phillips Bit
30170	3/8" Straight Slot Bit

29200 IMPACT SET INCLUDES:

Part No.	Tool
29000	3/8" Impact Tool
29520	3/8" Bit Holder
29630	#1 Phillips Bit
30180	#2 Phillips Bit
29550	#3 Phillips Bit
30190	#4 Phillips Bit
30170	3/8" Straight Slot Bit

30750 HAND IMPACT TOOL SET

Loosens Rusted or Frozen Screws Quickly...Manually.

A popular tool also available in a smaller, easy-to-display clam-shell package. Simply strike with a hammer. Each impact turns the bit 20° and develops up to 200 ft-lbs torque to free rusted or frozen screws. Can also be used with 1/2" drive impact sockets. Includes #2, #3, #4 Phillips and 3/8" straight bits with 5/16" hex drive.

30750 Hand Impact Tool Set. Clam Shell. Shipping wt. 2 lbs. 2 oz.

Bits Included:

29550	#3 Phillips Bit
30170	Straight Slot Bit
30180	#2 Phillips Bit
30190	#4 Phillips Bit
61630	61640
61660	61670



60530 SMALL FASTENER REMOVER

For Use with a Pneumatic Impact Tool to Loosen Rusted or Seized Fasteners.

A 3/4" open end wrench can be used to turn the bit holder while impacting the fastener. A locking pin in the driver keeps the bit holder in place on the square drive for safe operation. The bit holder can be removed from the driver by depressing the pin. Works faster than hand impact tools. Especially useful for removing brake rotor screws. The tool works with 5/16" hex impact bits. Kit includes Phillips #1, #2, #3, #4 and a straight slot bit.

60530 Small Fastener Remover. Skin-Packed. Shipping wt. 13 oz.

29630 #1 Phillips Bit	30180 #2 Phillips Bit	29550 #3 Phillips Bit
30190 #4 Phillips Bit	30170 Straight Slot Bit	60540 Driver
60550 Bit Holder	60600 Bit Set with Holder	



FASTENER

64100 ACTUATOR MOTOR WRENCH SET

Toothless, Infinite Ratchet and Hinged Handle Design Make it Easier to Remove and Replace Fasteners on Small, Electric HVAC Motors.

These motors control air flow into the vehicle and are commonly found in confined areas under the vehicle dash. The ratchet can be flipped to switch from clockwise to counterclockwise drive. Includes 8mm socket and 1/4" Square Drive Adapter for use with 1/4" sockets and bit holders. Most commonly found fasteners are 5.5mm, 8mm and T-15 Torx®. Can also be used in other hard-to-reach applications.

64100 Actuator Motor Wrench Set. Skin-Packed. Shipping wt. 7 oz.

61210 1/4" Square Drive

64110 Actuator Motor Wrench

64170 8mm Socket



YouTube

19250 STUCK BOLT, NUT, AND STUD REMOVER SET

6 Piece Set Removes Standard and Metric Bolts, Nuts and Studs from 1/4" to 9/16" (6mm to 14mm).

Drive the proper size remover over the bolt head, nut or stud. The remover spline cuts into the bolt head or threads for a sure grip.

19250 Stuck Bolt, Nut, and Stud Remover Set. Clam Shell. Shipping wt. 12 oz.

19260 #1 Remover. Fits 1/4" and 6mm.

19270 #2 Remover. Fits 5/16" and 8mm.

19280 #3 Remover. Fits 3/8" and 10mm.

19290 #4 Remover. Fits 7/16" and 11mm.

19300 #5 Remover. Fits 1/2" and 13mm.

19310 #6 Remover. Fits 9/16" and 14mm.

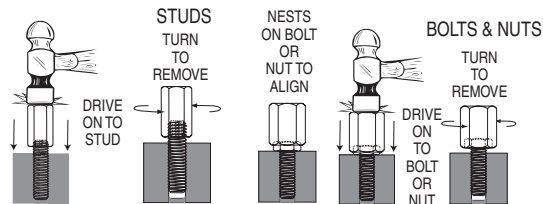

71200 STUD REMOVER

Removes Studs from Engine Blocks, Exhaust Manifolds, Cylinder Heads and Other Applications.

Allows for easy removal of studs. Tool has two holes, 1/2" (14mm) and 3/4" (19mm) for optimum fit, minimizing damage to threads. Range 3/8" (10mm) – 3/4" (19mm). Design allows tool to grip flush with mounting surface of the stud so it can grab studs that are broken off very close to the mounting surface. Use with 1/2" square drive.

71200 Stud Remover. Clam Shell. Shipping wt. 20 oz.



64250 RIGHT ANGLE RATCHETING SCREWDRIVER

Use Where a Screwdriver Won't Fit.

Makes it easy to remove and install molding around fender wells and other tight places. Place handle over the bit and turn. Reverse handle on bit to tighten. Can also be used with 1/4" round shaft screwdriver. Ratcheting action with infinite settings. Includes straight slot and #2 Phillips bit assemblies.

64250 Right Angle Ratcheting Screwdriver. Skin-Packed. Shipping wt. 6 oz.

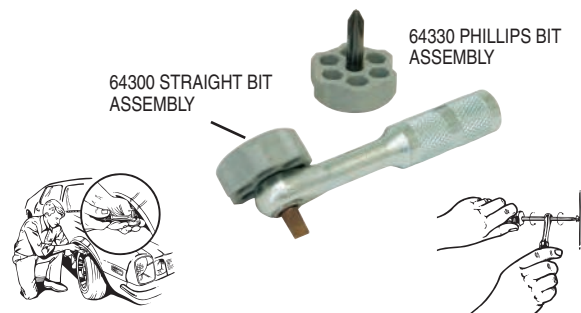

64650 IGNITION MODULE WRENCH FOR FORD

For 7/32" Hex Retaining Bolts on Ford Ignition Module. May be used with 1/2" wrench.

64650 Ignition Modulator Wrench for Ford. Skin-Packed. Shipping wt. 2 oz.



28100 TORQUE ANGLE METER

For All Torque-to-Yield Fastener Applications.

Commonly used for tightening head bolts and other bolts where a torque angle is required. Use with 1/2" drive.

28100 Torque Angle Meter. Skin-Packed. Shipping wt. 13 oz.

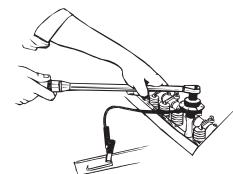

49200 HEAVY DUTY INTERNAL / EXTERNAL SNAP RING PLIERS

Reversible Action for Internal and External Applications.

The heavy duty plier construction and larger tips are designed for larger snap rings. The tool quickly converts from internal to external use by pivoting the handles. Tough tool easily compresses internal rings and expands external rings. Conical tip ends prevent the snap ring from slipping off the tips. Ten tip sets in a handy plastic pouch are included to fit a wide range of snap ring sizes. Tips are easily interchanged by turning a set screw, wrench included.

49200 Heavy Duty Snap Ring Pliers. Skin-Packed. Shipping wt. 12 oz.

49460 Replacement Tips

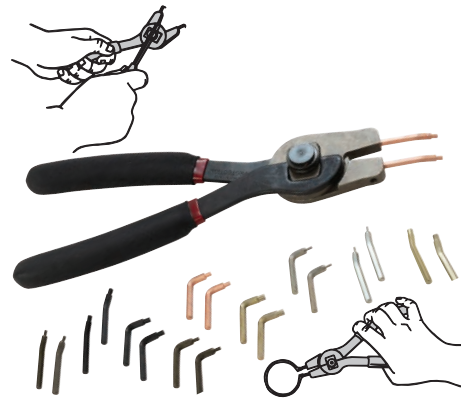

49460 Tip Set Includes Two Each of the Following Sizes:	
Diameter	Angle
.060"	75°
.060"	15°
.075"	75°
.075"	15°
.090"	75°
.090"	15°
.108"	75°
.108"	15°
.125"	75°
.125"	15°

46200 SNAP RING PLIERS, SMALL

Reversible Action for Both Internal and External Snap Rings. Smaller Design to Fit Tight Spaces.

The tool quickly converts from internal to external use. Simply pivot each handle to the opposite side to reverse action. Includes four pairs of tips to fit a wide range of snap ring sizes. 45° and 90° tips for hard to reach areas. Conical tip ends prevent the snap ring from slipping off of the tips.

46200 Snap Ring Pliers, Small. Skin-Packed. Shipping wt. 4 oz.

46250 Replacement Tip Set.



46250 Replacement Tip Set Includes:

- .045" straight tips
- .060" straight tips
- .045" 45 degree tips
- .035" 90 degree tips



EXTERNAL SNAP RING



INTERNAL SNAP RING

46000 COMBINATION INTERNAL / EXTERNAL SNAP RING PLIERS

A Handy Combination Tool for Internal and External Snap Rings.

Compresses internal rings in one position. Move the quick-change reversing lever to expand external rings. Four sets of tips in a plastic box.

46000 Snap Ring Pliers. Skin-Packed. Shipping wt. 7 oz.

46250 Replacement Tip Set



EXPANDS EXTERNAL RINGS



EASY, QUICK CHANGE REVERSING LEVER



COMPRESS INTERNAL RINGS

44900 LOCK RING PLIERS

For Removing and Installing All Types of Lock Rings.

Spreads lock rings commonly found on transmissions, master cylinders, brakes and other applications. Specially designed jaws are knurled on the end to prevent slipping.

44900 Lock Ring Pliers. Skin-Packed. Shipping wt. 8 oz.



42400 5 PC. AIR LINE DISCONNECT SET

Disconnects Quick Connect Push-In Connectors Found on Heavy-Duty Truck Air Systems and More.

Disconnects air systems on brakes, suspension, steering, engine, transmission and other auxiliary equipment. Also disconnects other quick connect push-in fittings, including: flow control valves, check valves, shuttle valves, quick exhaust valves and other function control fittings. Smallest size works on automatic adjusting air suspension systems for automobiles. Five popular sizes: 1/8-5/32", 1/4", 3/8", 1/2" and 5/8". Each tool is double-ended for hard-to-reach areas.

42400 5 pc. Air Line Disconnect Set. Skin-Packed. Shipping wt. 1 lb.

42100 1/4" Air Line Disconnect 42110 3/8" Air Line Disconnect

42120 1/2" Air Line Disconnect 42130 5/8" Air Line Disconnect

42470 1/8-5/32" Air Line Disconnect

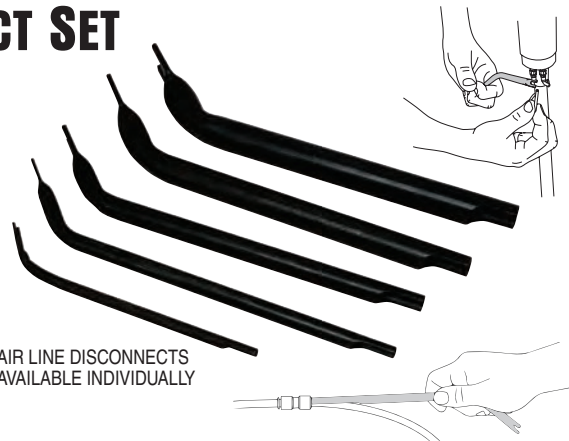

AIR LINE DISCONNECTS AVAILABLE INDIVIDUALLY

26550 27200 27740 TORX® BIT SETS

Sizes for Most Applications, T-10 through T-60.

All Torx® bits are made of heat-treated alloy steel.

26550 - 9 pc. set includes T-10 through T-50.

Our 27200 - 12 pc. set includes the same bits as our 9 pc. set, plus the T-47, T-55 & T-60 bits. 27740 - 3 pc. set includes T-40, T-45, & T-50 sizes for servicing disc brakes fitting GM & Ford brake caliper Torx bolts. T-10 through T-30 are 1/4" drive. T-40 through T-55 are 3/8" drive. T-60 is 1/2" drive.

26550 9 Piece Torx® Bit Set. Skin-Packed. Shipping wt. 8 oz.

27200 12 Piece Torx® Bit Set. Skin-Packed. Shipping wt. 15 oz.

27740 Brake Caliper Torx® Bit Set. Skin-Packed. Shipping wt. 5 oz.

*Both sets in convenient vinyl holder. All bits are available individually Skin-Packed.



26550 Includes:

Part No.	Torx Size
26560	T-10
26570	T-15
26580	T-20
26590	T-25
26600	T-27
26610	T-30
26620	T-40
26630	T-45
26640	T-50

27740 Includes:

Part No.	Torx Size
26620	T-40
26630	T-45
26640	T-50



27200 Includes:

Part No.	Torx Size
26560	T-10
26570	T-15
26580	T-20
26590	T-25
26600	T-27
26610	T-30
26620	T-40
26630	T-45
26500	T-47
26640	T-50
26650	T-55
26520	T-60

27530 T-70 TORX® BIT

Fits the Torque Converter Drain Plug.

Works on 2003 and later Subaru Legacy, Forester, Impreza and brake rotor retaining bolts on GM C4500 trucks. 1/2" drive.

27530 T-70 Torx® Bit. Skin-Packed. Shipping wt. 4 oz.



27490 E-4 TORX® SOCKET

For Electrical Ignition Switches On GM.

This extra deep socket is used on some General Motors ignition switches, 1/4" drive.

27490 E-4 Torx® Socket. Skin-Packed. Shipping wt. 1 oz.

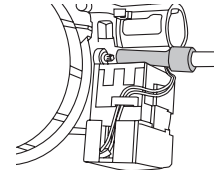

83210 EP-24 TORX PLUS® SOCKET

For 2017 Ford F-250, F-350 & F-450 Bed Bolts.

Socket is designed to quickly engage low-profile fasteners. Can also be used on other EP-24 Torx Plus applications. Made of strong heat-treated alloy steel.

83210 EP-24 Torx Plus Socket. Hang Tag. Shipping wt. 5 oz.



83100 EXTERNAL TORX PLUS® SOCKET SET

Nine of the Most Popular Torx Plus® Socket Sizes for Automotive Applications.

External Torx Plus® applications include body panels on newer Ford trucks with aluminum bodies and seats on GM trucks. Standard Torx® sockets will not fit Torx Plus® fasteners. Three smaller sockets are 1/4" drive, five sockets are 3/8" drive and largest socket is 1/2" drive.

83100 External Torx Plus® Socket Set. Skin-Packed. 14 oz.



Part No.	Torx Size
83110	EP-6
83120	EP-7
83130	EP-8
83140	EP-10
83150	EP-11
83160	EP-12
83170	EP-14
83180	EP-16
83190	EP-18

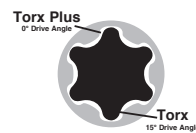

TORX®

26280 26750 TORX® SOCKET SETS

For External Torx® Bolts.

26280 includes 10 sizes, E5 through E20. The four smaller sizes are 1/4" drive; the next four sizes are 3/8" drive; the two largest sizes are 1/2" drive.

26750 has seven sizes E-6 thru E-16. The three smaller sizes are 1/4" drive; the four larger sizes are 3/8" drive.

Made of heat-treated alloy steel. Sockets are kept in a convenient vinyl holder.

26280 Torx® Socket Set, 10 pc. Skin-Packed. Shipping wt. 1 lb.

26750 Torx® Socket Set, 7 pc. Skin-Packed. Shipping wt. 9 oz.



Part No.	Torx Size	Bol Size
26770	E-5	#8, 4mm
26780	E-6	#10, 5mm
26790	E-7	5/16 stud
26800	E-8	#12 & 1/4", 6mm
26820	E-10	5/16", 8mm
26830	E-12	3/8", 10mm
26840	E-14	7/16", 12mm
26850	E-16	1/2"
26860	E-18	9/16", 14mm
26870	E-20	5/8", 16mm

SET INCLUDES CONVENIENT VINYL HOLDER

ALL SOCKETS ARE AVAILABLE INDIVIDUALLY Skin-Packed

Part No.	Torx Size	Bolt Size
26780	E6	#8
26790	E7	#10
26800	E8	#12 and 1/4"
26820	E10	5/16"
26830	E12	3/8"
26840	E14	7/16"
26850	E16	1/2"

26000 TAMPER RESISTANT TORX® BIT SET

Seven 1/4" Hex Insert Bits with 1/4" Drive Bit Holder. T-10 through T-40.

Fits tamper-resistant Torx® fasteners found on radio mountings, exterior mirrors, carburetors and other applications.

26000 Tamper-Resistant Torx® Bit Set. Skin-Packed. Shipping wt. 3 oz.



Part No.	Torx Size
26010	T-10
26020	T-15
26030	T-20
26040	T-25
26050	T-27
26060	T-30
26070	T-40
26080	Bit Holder

26530 MASTER TAMPER RESISTANT TORX® BIT SET

Ten hex insert bits with two bit holders. Includes Torx® sizes T-10 through T-55.

Seven smallest bits are used with the 1/4" bit holder. Three largest bits use the 3/8" bit holder. Convenient vinyl holder.

26530 Master Tamper Resistant Torx® Bit Set. Skin-Packed. Shipping wt. 7 oz.



Part No.	Torx Size
26010	T-10
26020	T-15
26030	T-20
26040	T-25
26050	T-27
26060	T-30
26070	T-40
27560	T-45
27580	T-50
27600	T-55
26080	1/4" Bit Holder
27630	3/8" Bit Holder

81000 TORXPLUS® BIT SET

Nine of the Most Popular Torx Plus® Sizes for Automotive Applications.

Torx Plus® drivers will not fit standard Torx® fasteners. Standard Torx® drivers will fit Torx Plus® fasteners, but not to full torque because of the loose fit, and are not recommended. Some common Torx Plus® applications include GM transmission bell housing bolts, Ford seat belt anchors and Ford pick-up bed bolts. Set includes: TP-10, TP-15, TP-20, TP-25, TP-27, TP-30, TP-40, TP-45 and TP-50. Six smaller bits are 1/4" drive and three larger bits are 3/8" drive. Vinyl holder for storage included. All bits plus TP-55 and TP-60 are available individually.

81000 Torx Plus® Bit Set. Skin-Packed. Shipping wt. 11 oz.



81100 TP-55
81110 TP-60

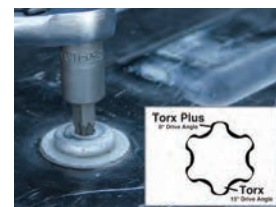

Part No.	Torx Size
81010	TP-10
81020	TP-15
81030	TP-20
81040	TP-25
81050	TP-27
81060	TP-30
81070	TP-40
81080	TP-45
81090	TP-50
81100	TP-55
81110	TP-60

35260 PLASTIC FASTENER REMOVER

Removes Plastic Hold-Down Fasteners.

This tool quickly removes various types of plastic fasteners that hold on weather stripping, radiator shrouds, fender linings, air dams and other plastic or rubber parts. The tool is equipped with a sliding urethane bumper for use when extra leverage is necessary.

35260 Plastic Fastener Remover. Skin-Packed. Shipping wt. 3 oz.



REMOVING WEATHER STRIPPING

REMOVING PLASTIC RIVET

U.S. Pat No. 6,663,082

35300 V-GROOVE CLIP REMOVER

Narrow Tip with V Groove for Removing Plastic Clips Used on Upholstery, Door Panels, Radiator Shrouds, Fender Liners and Weather Stripping.

The tool is equipped with a sliding urethane bumper for use when extra leverage is necessary. Also use the bumper to protect the vehicle surface.

35300 V-Groove Clip Remover. Skin-Packed. Shipping wt. 4 oz.



35260

35300

U.S. Pat. No. 6,663,082

35400 DOOR UPHOLSTERY REMOVER

For Plastic Fasteners.

Place the tool under the edge of the door panel and insert into fastener as far as possible...then simply pry up. Rugged tool with a large comfortable handle.

35400 Door Upholstery Remover. Skin-Packed. Shipping wt. 7 oz.

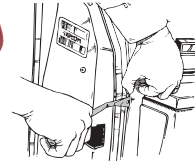

BODY

35600 LONG DOOR PANEL TOOL

19.75" Long Tool is Great to Reach Upholstery Clips in the Middle of a Door Panel.

Square notch design removes both plastic and metal clips on cars and trucks. Helps eliminate broken fasteners.

Place the tool under the edge of the door upholstery panel and insert into the fastener as far as possible...then simply pry up. Heat treated for durability.

35600 Long Door Panel Tool. Hang Card. Shipping wt. 11 oz.

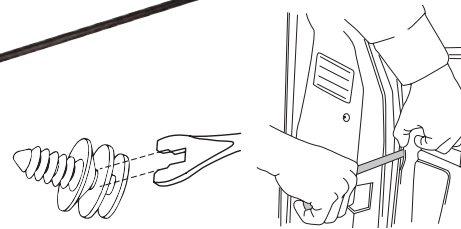

35350 DOOR PANEL REMOVER

Removes Door Panel Fasteners, Even In Tight Spaces.

The bent handle design allows use where space is limited, and provides extra prying force. The unique, square cutout in the tool tip provides a no-slip grip, even on fasteners with small ears.

35350 Door Panel Remover. Skin-Packed. Shipping wt. 8 oz.

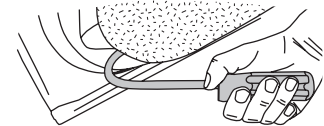
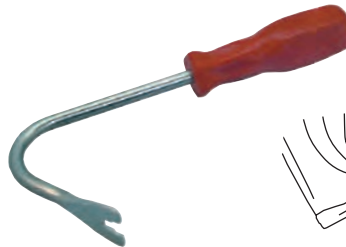

61400 STRAIGHT HOG RING PLIERS

61410 ANGLED HOG RING PLIERS

Close Hog Ring Fasteners Used on Upholstery.

Steel pliers are durable and easy to use. Spring loaded jaws hold the hog ring. Cushioned grips for comfort. Angled Pliers have a 45° angled head to fit into tight spaces.

61400 Straight Hog Ring Pliers. Skin-Packed. Shipping wt. 8 oz.

61410 Angled Hog Ring Pliers. Skin-Packed. Shipping wt. 8 oz.



35440 BODY TRIM TOOL SET, 3 PIECE

Clip Remover Helps Remove Door Handle and Window Crank Clips.

Works on GM, Ford and others using common "C" type clip. Upholstery and Panel Removers are designed for plastic fasteners.

35440 Body Trim Tool Set, 3 Piece. Clam Shell. Shipping wt. 1 lb. 4 oz.

35350 Door Panel Remover 35400 Door Upholstery Remover

54960 Window and Door Clip Remover



18600 WINDOW AND DOOR CLIP REMOVER / INSTALLER

Removes and Installs Door Handle and Window Crank Clips.

Works on the common "C" type clip. Really fast and easy. Helps prevent damage to door panel upholstery. Opposite end firmly holds clip for easy installation.

18600 Window and Door Clip Remover / Installer. Skin-Packed. Shipping wt. 6 oz.

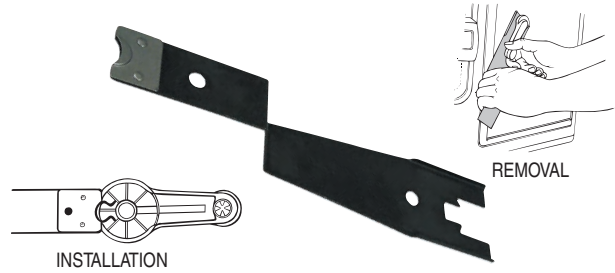

42810 42870 42880 PLASTIC CLIP REMOVAL PLIERS, STRAIGHT, 45° & 80°

Straight, 45 and 80 Degree Angled Tips for Easy Removal of Plastic Push Pin Type Panel Fasteners with Center Pins.

Fits into recessed pin locations found on some vehicles. Also works on traditional clips. Integrated spring makes tool easier to use. Built-in cutter allows technician to cut off fastener head. Also used to remove ATO, Micro, Mini Blade, Maxi and Pal type automotive fuses from panel.

42810 Plastic Clip Removal Pliers. Skin-Packed. Shipping wt. 7 oz.

42870 Clip Pliers 45°. Skin-Packed. Shipping wt. 8 oz.

42880 Clip Pliers 80°. Skin-Packed. Shipping wt. 8 oz.



41080 41090 TRIM CLIP PLIERS

Easily Removes Trim Panel Fasteners.

Specially designed double tapered tips slide under the clip and grip the side of the clip, helping prevent damage. Tips are angled 45° & 90° providing more leverage for easier clip removal, even in very tight spots. Dual durometer cushioned grips for comfort.

41080 45° Trim Clip Pliers. Skin-Packed. Shipping wt. 7 oz.

41090 90° Trim Clip Pliers. Skin-Packed. Shipping wt. 7 oz.



35460 DOUBLE ENDED CLIP LIFTER

Thin Tips on this Double-Ended Tool Provide Easy Access When Removing Plastic Clips.

Smaller opening works for lifting the center pin and the wider opening lifts the fastener from the panel. Also works on most plastic fasteners, plastic clips, upholstery or door panels. Zinc finish with 3-1/2" grip. Overall tool length is 8".

35460 Double Ended Clip Lifter. Skin-Packed. Shipping wt. 3 oz.



42050 42060 42070 PUSH PIN PLIERS WITH SPRING

For Easy Removal of Plastic Push Pin Type Panel Fasteners with Center Pins. Angled Pliers Tips will Not Damage the Pin or Anchor. Spring Action Makes Tool Easier to Use.

Plier tips are angled 30° - 42060 / 80° - 42050 for use in tight spaces such as wheel wells. Designed to prevent damage to the pin or anchor. Dual durometer grips for comfort.

42050 Push Pin Pliers. Skin-Packed. Shipping wt. 8 oz.

42060 Push Pin Pliers, 30 Degree. Skin-Packed. Shipping wt. 8 oz.

42070 Push Pin Pliers, 80 Degree. Skin-Packed. Shipping wt. 8 oz.



42050

Supersedes 41250



42060 - 30° Tip

Supersedes 42420



42070 - 80° Tip

Supersedes 42430



BODY

42480 PANEL CLIP PLIERS

Spring Loaded Pliers Provides Extra Leverage to Remove Door Clips Without Damage.

Ergonomic spring loaded handles are rotated 90° to provide leverage needed to easily remove push in fasteners. The tapered forked end makes getting under the clips easier and helps prevent damage to the clips or door panel. Works on a wide range of push in clip sizes.

42480 Panel Clip Pliers. Skin-Packed. Shipping wt. 7 oz.



81140 PIGTAIL RUBBER GASKET TOOL

Rounded and Polished Steel Tip Slides the Self-Locking Part of the Rubber Gasket Into the Locking Channel.

The shape of the steel tip is designed without sharp edges that could cut the gasket and features the proper shape needed to perform the job. Ergonomic dual durometer handle provides the necessary leverage needed.

81140 Pigtail Rubber Gasket Tool. Mini Pouch. Shipping wt. 3 oz.



81950 MOLDING STRIP TOOL

The 3" Wide Sharp Edge Allows the Technician to Easily Get Under Door Moldings and Emblems.

The wedge angle makes it easy to separate the double-sided tape from the door and the vehicle body. The high-impact acetal construction allows use with a mallet on stubborn applications. The plastic construction won't mark or scratch vehicle finish.

81950 Molding Strip Tool. Skin-Packed. Shipping wt. 7 oz.



81200 PLASTIC CHISEL SCRAPER SET

Set of Three Plastic Chisels for Removing Emblems and Adhesive Backed Trim Without Damage.

The one piece high-impact plastic chisels can also be used to remove stick-on weights from aluminum wheels as well as gaskets from aluminum, without marring. The plastic blades can be resharpened as needed. The set includes 3/4", 1" and 1-1/2" blade widths. Hand guard and hang hole are built into each flexible scraper.

81200 Plastic Chisel Scraper Set. Skin-Packed. Shipping wt. 13 oz.

81210 3/4" Plastic Chisel Scraper

81220 1" Plastic Chisel Scraper

81230 1-1/2" Plastic Chisel Scraper

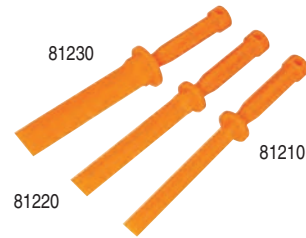

59250 MOLDING REMOVER SET

Quickly Removes Body Moldings.

Two spring steel blades, 2" and 3-1/2", are included for all sizes of body moldings. Use with the conventional handle, or for tough jobs, attach the pneumatic driver for use with an air hammer set at 40 psi or less. The replaceable blades flex to follow the body contour.

59250 Molding Remover Set. Skin-Packed. Shipping wt. 9 oz.

59300 3-1/2" Blade

59310 2" Blade

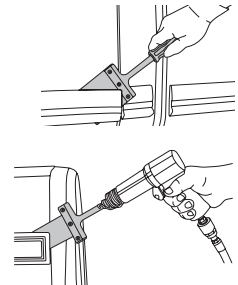

BODY

32860 DOOR HANDLE SPRING RETAINER TOOL FOR GM

Allows Outer Door Handle Replacement Without Removal of the Interior Door Panel on GM Vehicles.

Designed to prevent damage to the door components and finish. Works on 2014 and newer Yukon, Tahoe, Suburban, Silverado, Sierra, Impala and Escalade.

32860 Door Handle Spring Retainer Tool for GM. Skin-Packed. Shipping wt. 2 oz.



65750 WINDSHIELD WIPER ARM REMOVER

Makes Wiper Arm Removal and Replacement an Easy Job.

Easily removes wiper arms without damage to car finish.

65750 Windshield Wiper Arm Remover. Skin-Packed. Shipping wt. 4 oz.

NSN 5120-00-419-5693

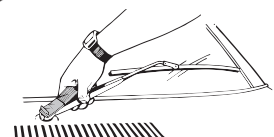

35200 WINDSHIELD MOLDING / DOOR HANDLE CLIP PLIERS

For removing most windshield molding clips and door handle clips.

Releases clips to remove chrome molding on most windshields and rear glass. Offset handle permits easy access to molding clips. Slips under door handle without damage to panel material.

35200 Windshield Molding/Door Handle Clip Pliers. Skin-Packed. Ship wt. 5 oz.

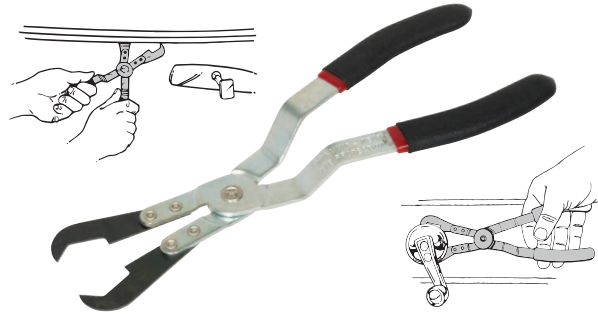

47000 WINDSHIELD LOCKING STRIP TOOL

Two Double-Ended Tips to Fit Most All Applications.

Unique design allows tip to swivel 90° in either direction to work where others won't. Just select the tip with opening that most closely fits locking strip, and then feed locking strip into eyelet.

47000 Windshield Locking Strip Tool. Skin-Packed. Shipping wt. 7 oz.

TIP SWIVELS 90° IN EITHER DIRECTION

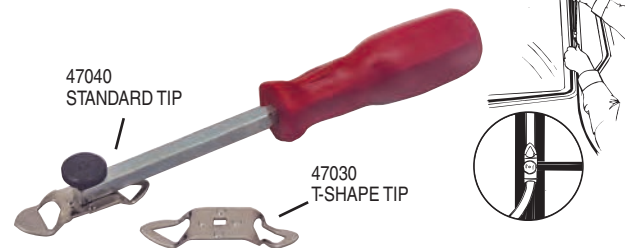

48600 OFFSET WINDSHIELD LOCKING STRIP TOOL

Offset Handle for Extra Clearance.

Offset design provides installers extra clearance to work on windshields or other glass on semis, skid loaders and agricultural applications with locking strips. Tip swivels 90° in either direction. Select the tip with opening that most closely fits locking strip.

48600 Offset Windshield Locking Strip Tool. Skin-Packed. Shipping wt. 6 oz.

47030 T-Shape Tip

47040 Standard Tip



83060 LONG GLASS CHANNEL CLEANING TOOL

Designed to Remove Broken Glass Remnants from Glass Channels in Vehicle Doors.

Hooked tip with rounded end to get inside channel lip without damaging the rubber channel. Overall tool length 22.75" to reach the bottom of the channel on many vehicles.

83060 Long Glass Channel Cleaning Tool. Hang Card. Shipping wt. 8 oz.



83350 GLASS DEBRIS CLEANING TOOL

Flexible Tool Shaft Follows the Contour of the Bottom of the Door to Help Move Broken Glass to an Area Where It Can Be Removed.

Vinyl caps protect the prongs from scratching the bottom of the door. The 23" flexible steel shaft with small handle provides easy access in tight spaces. Extra vinyl caps are provided.

83350 Glass Debris Cleaning Tool. Hang Card. Shipping wt. 3 oz.

30420 Vinyl Caps, 6 pc..

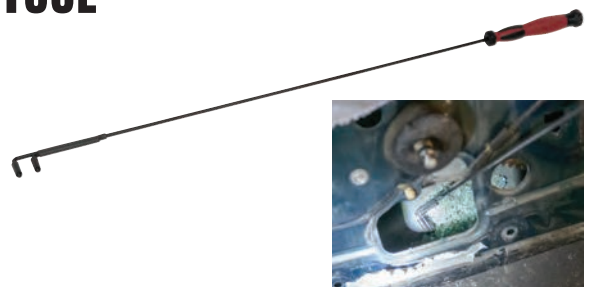

63900 WINDOW HOLDER

Holds Door Glass While Working on Window Regulator.

Works on all cars and trucks with a top door frame. Simply loop cable over door frame and attach suction cups to each side of glass. Window glass is then securely held above the door while work is performed.

63900 Window Holder. Clam Shell. Shipping wt. 5 oz.

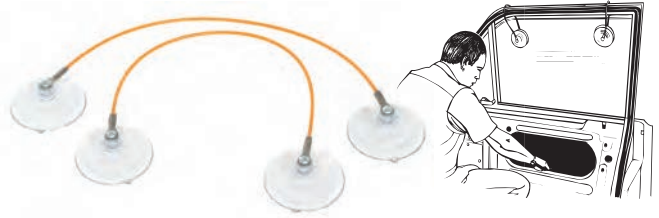

35150 WINDOW BELT MOLDING REMOVER

Quickly Removes All Window Belt Moldings.

Slide the powder-coated tool downward between the window exterior and the door. The channel side of the tool should face the door. When the tool channel is below the belt molding, push or pull the tool upward. The tool quickly removes the belt molding without damage to the window or the molding. Fits most domestic and import vehicles.

35150 Window Belt Molding Remover. Skin-Packed. Shipping wt. 5 oz.



U.S. Pat No. 7,147,209

35240 BELT MOLDING TOOL

Unique Flared Head Design and Beveled Edges Allow the Tool to be Inserted Under the Molding at an Angle.

Makes removal of newer belt moldings easy. For clipless moldings, the tool is twisted or pulled back to release the molding from the door tab. For moldings with metal clips, hook the tool under each clip and pull up. Quickly removes belt molding without damage. Works on most domestic and import vehicles.

35240 Belt Molding Tool. Skin-Packed. Shipping wt. 4 oz.



YouTube

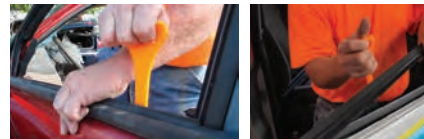

U.S. Pat No. 9,505,111

83080 WIRE HANDLE PULLER SET, 2 PC.

Set Includes Two Wire Gripping Handles for Cutting Auto Glass Urethane.

Wire handles can be used with a variety of wire materials. Simply feed the wire through the hole in the steel wedge, loop it through the slot at the top of the shaft, and then back into the large plastic handle.

83080 Wire Handle Puller Set, 2 pc. Hang Card. Shipping wt. 8 oz.

82990 Wire Handle Puller, 1 pc.



83090 FIBER WIRE

Fiber wire for use with 83080 Wire Handle Puller Set, 2 pc. to Cut Auto Glass Urethane.

25m spool for easy dispensing. Nylon woven line will not damage vehicle surfaces.

83090 Fiber Wire. Mini Pouch. Shipping wt. 2 oz.



82870 FIBER LINE CUTTER

Designed to Safely Cut Fiber Line from Spools for Auto Glass Removal.

Recessed blade design to help prevent injury. Replaceable blade with dual carbon steel cutting surfaces. Replacement blade is available.

82870 Fiber Line Cutter. Skin-Packed. Shipping wt. 2 oz.

82880 Replacement Blade



68240 UNIVERSAL TRIM HOOK TOOL

Double-Ended Trim Hook Works on Door Moldings, Dash Trim and Door Seals.

Designed to safely pry small bezel components from interiors without damage. Pointed tip fits great in very small gaps. Made of durable plastic.

68240 Universal Trim Hook Tool. Skin-Packed. Shipping wt. 1 oz.

**65800 DOOR ADJUSTER**

Adjusts Door Hinges on Most All Cars and Light Trucks.

Will adjust doors with either bolted or welded hinges. Simply slide pin end of tool into door latch and close door until tool engages door striker. Now raise or lower tool handle to align door. Comes with two-headed pin adapter for both large and small latches. Specially designed handle for optimum leverage, makes adjustment fast and easy.

65800 Door Adjuster. Boxed. Shipping wt. 5 lbs. 2 oz.

65810 Two-Headed Pin Adapter.

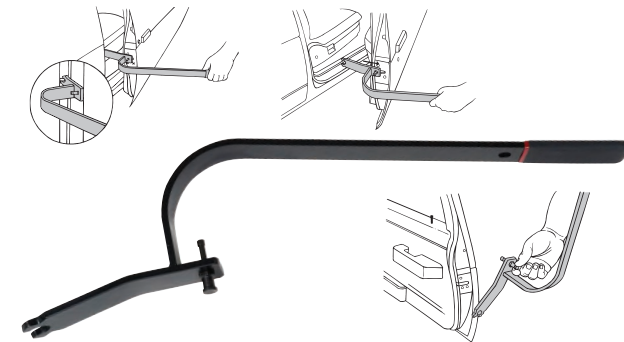
**51900 SPOT WELD CHISEL**

Separates Spot Welded Panels.

Use to separate panels after the spot weld has been drilled out. Drive the blade with a hammer from the end or the side through the panel seam. Panels are separated without damage. The blade is sharpened on three sides, and offset for clearance. NOTE: The sharpened edges will wear with use. Resharpener on a grinding wheel.

51900 Spot Weld Chisel. Skin-Packed. Shipping wt. 8 oz.

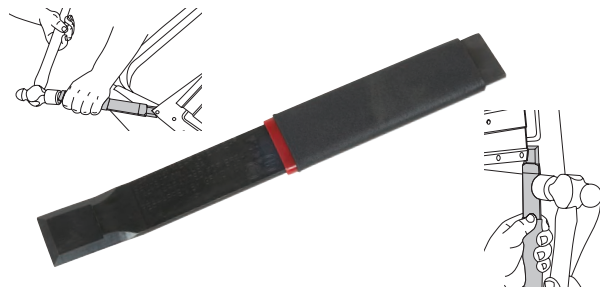
**51880 SPOT WELD CHISEL, 180**

Separates spot welded panels. Use to separate panels after the spot weld has been drilled out.

Drive the blade with a hammer from the top or the side through the panel. Panels are separated without damage. The blade is sharpened on three sides and offset for clearance.

51880 Spot Weld Chisel, 180. Skin-Packed. Shipping wt. 5 oz.

**56200 AIRBAG RELEASE TOOL, MOPAR**

Removes the Driver Side Airbag with Wire Spring Clips, Used on Many Chrysler, Dodge and Jeep Vehicles.

The wire spring clips are difficult to remove because they are very hard to see. There are three airbag retainer access holes on the back of the steering wheel. Used on Jeep Liberty (KK), Chrysler/Dodge mini van (RT/RM), Dodge Nitro (KA), Dodge Ram truck (DS), Chrysler PT Cruiser (PT) and Jeep Wrangler (JK).

56200 Airbag Release Tool, Mopar. Skin-Packed. Shipping wt. 2 oz.



29650 ANTENNA NUT SOCKET SET

For Removing or Replacing Antennas.

Four double-ended sockets fit eight common domestic & import antenna nuts. The smaller three sockets are 7/8" hex & the larger socket is 1-1/4" hex. Sockets are made of heat-treated alloy steel for strength. Complete applications are listed on the card. Sockets are also available individually.

29650 Antenna Nut Socket Set. Skin-Packed. Shipping wt. 12 oz.

29810 Antenna Nut Socket #1

29820 Antenna Nut Socket #2

29830 Antenna Nut Socket #3

29600 Antenna Nut Socket #4

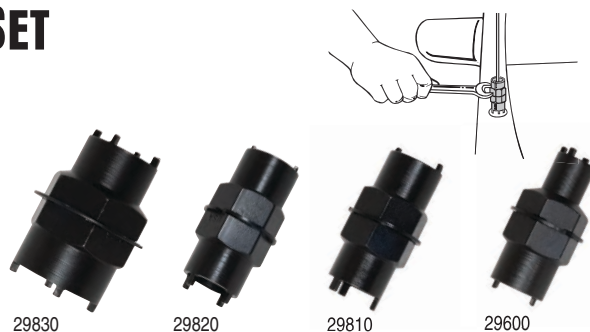

14540 HEADLIGHT ADJUSTING RATCHET FOR FORD

Works on Ford Aerodynamic Headlights with Rear Mounted Adjusters.

Tool is used to adjust aerodynamic headlights with rear mounted adjusters on Ford vehicles. These adjusters are not easily accessible and require this tool for adjusting. The extra long handle allows easy access to hard-to-reach spaces. Tool has a 4mm hex with a roller clutch for infinite settings.

14540 Headlight Adjusting Ratchet for Ford. Skin-Packed. Shipping wt. 6 oz.

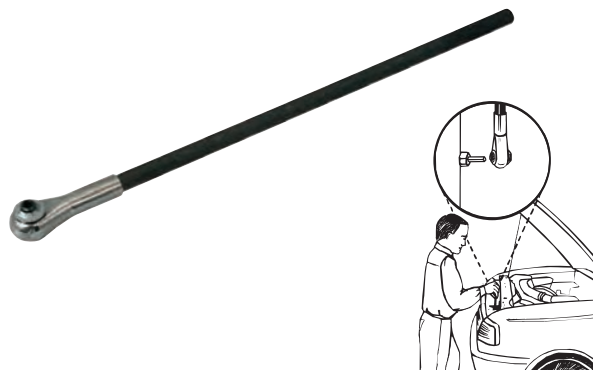

83590 ALL IN ONE MIRROR TOOL

Works on a Wide Range of Import and Domestic Vehicle Mirrors.

Includes a #2 Phillips, T-15 and T-20 drivers. Also comes with hook and pick devices that are perfect for loosening, prying, and aligning. The tools are made from high strength steel providing durability.

83590 All In One Mirror Tool. Skin-Packed. Shipping wt. 4 oz.

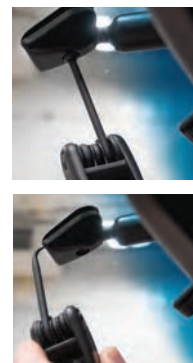

BODY

83050 MIRROR REMOVAL TOOL FOR FORD

Simply Slide the 2-Prong Tool into the Bracket with Gentle Upward Pressure While Moving the Tool Side-To-Side, the Mirror will Disconnect.

Works on some Ford vehicle rear view mirrors. Thin tip fits perfectly into the bracket. Double-dip grip for comfort.

83050 Mirror Removal Tool for Ford. Skin-Packed. Shipping wt. 4 oz.



60400 MIRROR REMOVAL WRENCH

Easily Removes Mirrors Held on By Spring Clip Without Damage to the Windshield or Mirror.

Simply insert the tip of the tool under the mirror where it attaches to the windshield. Push the tool towards the glass and down to release mirror from bracket. Coating on bend helps protect windshield.

60400 Mirror Removal Tool. Skin-Packed. Shipping wt. 4 oz.

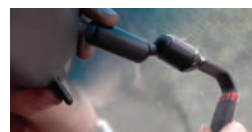

YouTube

69940 TRIM REMOVAL SET, 5 PC.

Strong and Impact Resistant when Used to Pry Against Trim or Metal Body Panels.

Used for all types of trim removal including side molding, window trim, door handle trim, grill trim and bumper moldings. Made of glass reinforced nylon. Neon orange for visibility.

69940 Trim Removal Set 5pc. Box. Shipping wt. 14 oz.

69950 Wide Trim Remover	69960 Pull Type Trim Remover
69970 Handy Trim Remover	69980 Narrow Trim Remover
69990 Upholstery Clip Remover	

Supersedes 68300

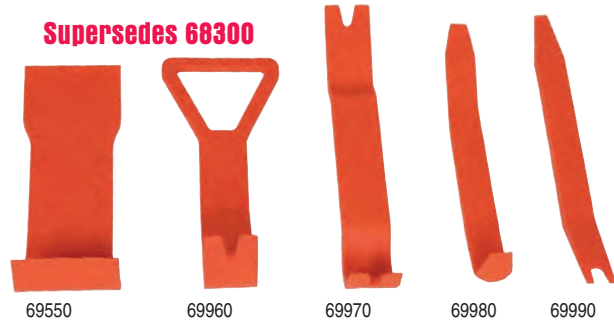

69620 WEDGE ASSORTMENT SET, 5 PC.

Strong and Impact Resistant when Used to Pry Against Trim or Metal Body Panels.

Used for all types of trim removal including side molding, window trim, door handle trim, grill trim and bumper moldings. Made of glass reinforced nylon. Neon orange for visibility.

69620 Wedge Assortment Set, 5 pc. Box. Shipping wt. 1lb. 1oz.

69630 Door Clip Wedge	69640 Wedge with Felt
69650 Thin Wedge	69660 Wide Wedge
69670 Angled Wedge	



68740 TRIM REMOVAL MASTER SET, 27 PC.

Helpful when Removing Any Type of Interior Trim Including Door Panels and Dash Pieces.

Used when replacing glass, installing stereo equipment, body work, and panel replacement. Strong impact resistant design made of glass reinforced nylon. Designed to be flexible and are less likely to dent or damage surfaces. Neon orange for visibility.

68740 Trim Removal Master Set, 27 pc. Box. Shipping wt. 2 lb. 12oz.

68750 Pouch	68760 Trim Tool #1	68770 Trim Tool #2
68780 Trim Tool #3	68790 Trim Tool #4	68800 Trim Tool #5
68810 Trim Tool #6	68820 Trim Tool #7	68830 Trim Tool #8
68840 Trim Tool #9	68850 Trim Tool #10	68860 Trim Tool #11
68870 Trim Tool #12	68880 Trim Tool #13	68890 Trim Tool #14
68900 Trim Tool #15	68910 Trim Tool #16	68920 Trim Tool #17
68930 Trim Tool #18	68940 Trim Tool #19	68950 Trim Tool #20
68960 Trim Tool #21	68970 Trim Tool #22	68980 Trim Tool #23
68990 Trim Tool #24	69010 Trim Tool #25	69020 Trim Tool #26
69030 Trim Tool #27		

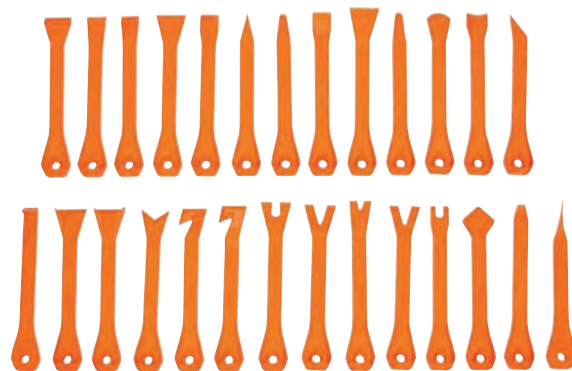

BODY

11120 BATTERY BRUSH

Cleans Dirt and Corrosion from Battery Terminals and Cable Clamps.

The external brush cleans cable clamps and internal brush cleans terminal posts. Case is made of high impact plastic that will not weaken in cleaning solutions.

11120 Battery Brush. Skin-Packed. Shipping wt. 3 oz.

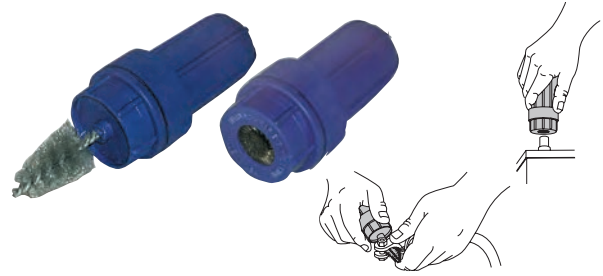

57850 BATTERY CARRIER

Lift and Carry Batteries Safely.

Sturdy steel jaws securely hold batteries. Spring-action handle turns lifting power into battery gripping pressure. Form-fitting handle provides a solid gripping surface for your hand. Carrier works on nearly all batteries, from motorcycles to boats. Saw-tooth jaw tips provide no-slip battery gripping power. Carrier grips the battery just below the top lip for good balance. A heavy-duty tool that is built to last.

57850 Battery Carrier. Hang Card. Shipping wt. 1 lb. 11 oz.

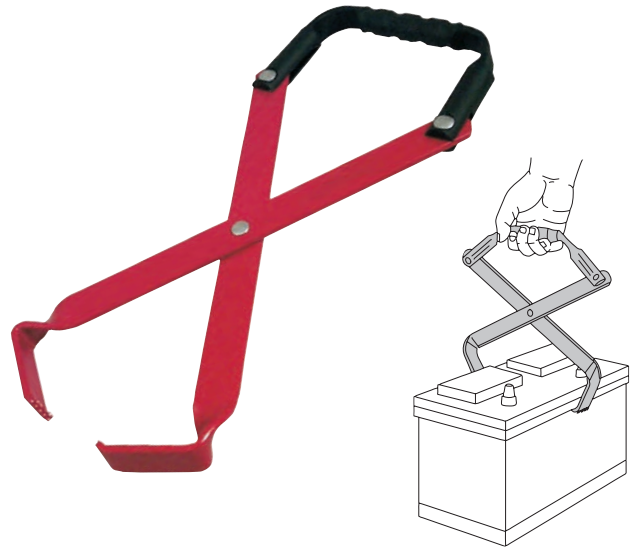

54150 BATTERY TERMINAL & WIPER ARM PULLER

Removes Battery Terminals and Bolted on Wiper Arms.

A dual-purpose puller. Easily removes stuck battery terminals. Tighten knurled cone to force jaws under the cable clamp. Turn center screw to lift clamp off terminal. Also removes bolted on windshield wiper arms that fit over a tapered spline. The puller screw pad is designed to fit the top of the spline post for easy pulling.

54150 Battery Terminal & Wiper Arm Puller. Skin-Packed. Shipping wt. 10 oz.

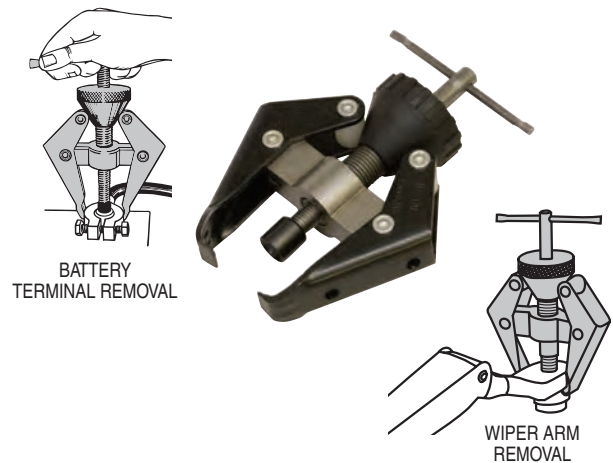

11400 SIDE TERMINAL BATTERY CLEANER

A Special Tool for a Special Job.

"Coil Spring" cutters polish the battery contact while stainless steel brushes clean the cable terminals.

11400 Side Terminal Battery Cleaner. Skin-Packed. Shipping wt. 2 oz.



60150 RELAY PRO® 12V AND 24V RELAY TESTER

A Simple Relay Tester That Will Easily And Quickly Test Most 12 And 24 Volt DC Automotive Relays.

Tests relays by simply clipping the test leads onto the relay terminal pins using a 12 or 24v DC power source. Tests a wide range of 4 and 5 pin relays. Including shielded, non-shielded, relays with different pin sizes and 4 pin normally closed relays that other testers may incorrectly show fail. Automatically determines the relay configuration so the fully insulated gator clips can be connected in any order. Eliminates guesswork because you don't need to connect to specific pins, like other testers. 45" power leads with heavy-duty gator clips provide a secure connection to the power source.

60150 Relay Pro® 12V and 24V Relay Tester Box. Shipping wt. 8 oz.

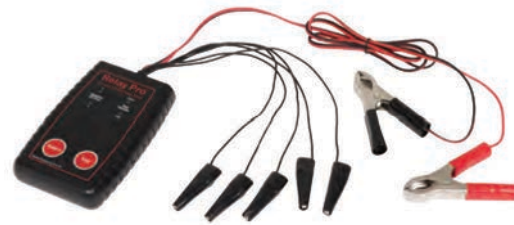

Patent Pending

69200 TEST LEAD KIT FOR RELAY TEST JUMPERS

Use with 56810 or 60610 to Easily and Securely Connect Relay Test Jumper to a Multimeter.

Can also use banana plug to pin probe adapter for use with pin probes. Kit contains two terminal to banana tip wires, two pin tip to banana plug adapters and one terminal to banana tip wire with jumper wire. Jumper wire may be used between common and open to close the relay circuit for testing and has a test port to easily check voltage. Also provides access for a clamp-on amp meter.

69200 Test Lead Kit for Relay Test Jumpers. Hang Card. Shipping wt. 2 oz.

69210 Orange Banana Plug Adapter (2)	69220 Terminal to Blue Plug
69230 Terminal to Yellow Plug	69240 Y Terminal to Green Plug

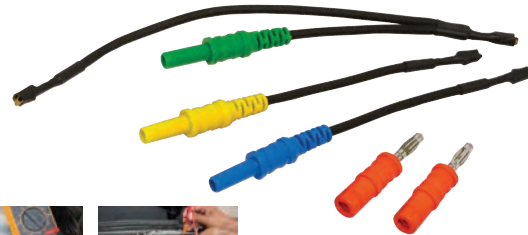

60660 DELUXE RELAY TEST KIT

Includes 8 Jumpers to Fit Most Popular Relays. Also Includes Test Lead Kit and Relay Puller Pliers.

Jumpers have tabs for clamping and flat pads to place test leads on. No need to pierce wires or connect multiple jumper wires. Also includes Test Lead Kit for easily and securely connecting Relay Test Jumpers to a multimeter. Jumper wire may be used between common and open to close the relay circuit for testing and has a test port to easily check voltage. Also provides access for a clamp-on amp meter. Relay Puller Pliers easily remove electrical relays without damage to the relay or electrical box.

60660 Deluxe Relay Test Kit. Molded Case. Shipping wt. 1 lbs. 8 oz.

46950 Relay Puller Pliers	56820 Yellow Jumper	56830 Red Jumper
56840 Blue Jumper	56850 Green Jumper	60620 Orange Jumper
60630 White Jumper	60640 Purple Jumper	60650 Grey Jumper
69210 Orange Banana Plug Adapter (2)	69220 Terminal to Blue Plug	
69230 Terminal to Yellow Plug	69240 Y Terminal to Green Plug	

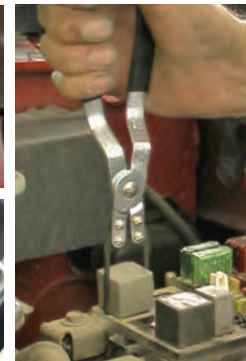

U.S. Pat No. 6,724,193

69300 MASTER RELAY AND FUSED CIRCUIT TEST KIT



Test Live Circuits from the Relay or Fuse Box. Extend the Capability of Your Digital Multimeter.

Includes eight jumpers to fit most popular relays. The jumpers have tabs for clamping and flat pads to place test leads on. Includes Test Lead Kit (see 69250 below) for easily and securely connecting Relay Test Jumpers to a multimeter. Terminal Leads with switch, fuse and power options provide easy access to check current or voltage on many fuses and relays used on vehicles today. Also allows testing of relay configurations not covered by our eight Relay Test Jumpers, Like Volkswagen, BMW and other European vehicles. Relay Puller Pliers easily remove electrical relays without damage to the relay or electrical box. Works without piercing wires.



69300 Master Relay and Fused Circuit Test Kit. Molded Case. Shipping wt. 2 lbs. 2 oz.

46950 Relay Puller Pliers 56820 Yellow Jumper 56830 Red Jumper

56840 Blue Jumper 56850 Green Jumper 60620 Orange Jumper

60630 White Jumper 60640 Purple Jumper 60650 Grey Jumper

69210 Orange Banana Plug Adapter (2) 69220 Terminal to Blue Plug

69230 Terminal to Yellow Plug 69240 Y Terminal to Green Plug

69260 On/Off Switch with 4mm Stackable Banana Plugs

69270 4mm Female Banana to Alligator Clamp - 4'

69280 Red 4mm Banana to 1/4" Female Terminal

69290 Green 4mm Banana to 1/4" Male Spade

69310 Yellow 4mm Banana to 2.75mm Male Spade

69320 Blue 4mm Banana to 7.75mm Male Spade

69330 Black 4mm Banana to Stripped Wire End

69340 4mm Banana Males with Inline ATO Fuse Holder

69350 4mm Female to 4mm Male Extension - 3-1/2'

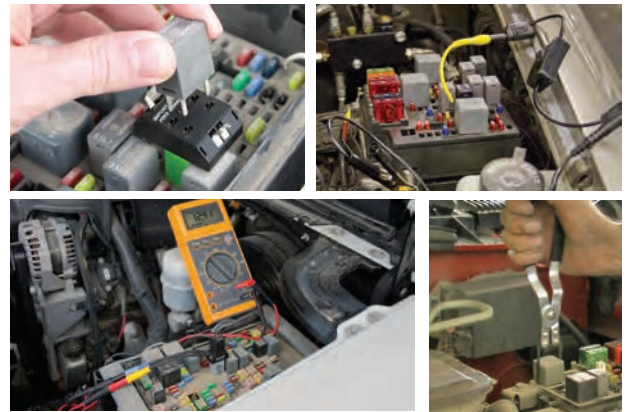

U.S. Pat No. 6,724,193

69250 TERMINAL LEADS WITH POWER/SWITCH/FUSE



Provides Easy Access to Check Current or Voltage on Nearly All of the Fuses and Relays Used on Vehicles Today.

- Terminal leads with switch/fuse/power provide several ways to check circuits from the fuse or relay box.
- Different sized ends on the wires give flexibility to plug directly in the relay base or to fit other relay sizes not covered by the relay test jumpers (like VW & BMW).
- Five wire sets (pairs) fit many vehicle fuses including: Female-Pal, JK, LJK, Male-L-mini, Mini ATO and Maxi.
- Use the on/off switch to control a circuit. Test before or after the switch by using the stacking Banana plugs.
- Power lead with alligator clip can apply external 12v power to only the circuit that is being worked on.
- Two 3.5 foot extension lead wires can be used if you are controlling a circuit while the vehicle is on a hoist.
- The in-line fuse holder (common ATO fuse style) protects the circuit and multimeter during testing.
- Allows testing without piercing wires.
- Add to 60660 to make the 69300.

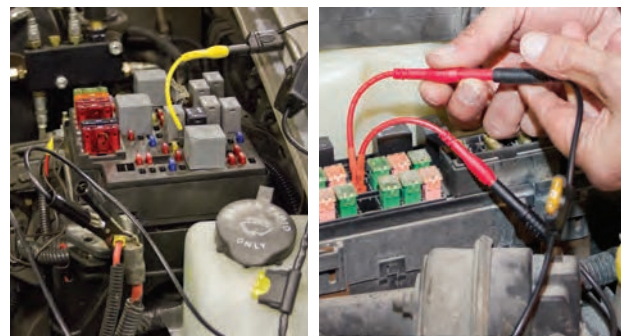

69250 Terminal Leads with Power/Switch/Fuse. Hang Card. Shipping wt. 13 oz

56810 RELAY TEST JUMPER KIT

Set of Four Relay Test Jumpers Make Testing Relays or Live Circuits Quick and Easy.

Set includes four jumpers to fit the most popular size relays on domestic and import vehicles. Simply remove relay to be tested, insert correct jumper and insert relay into jumper. When using green four pin jumper be careful to align pins on jumper and relay correctly. No need to pierce wires or connect multiple jumper wires. Jumpers have tabs for clamping and flat pads to place test leads on.

56810 Relay Test Jumper Kit. Molded Case. Shipping wt. 9 oz.

56820 Yellow Jumper	56830 Red Jumper
56840 Blue Jumper	56850 Green Jumper



U.S. Pat No. 6,724,193

60610 RELAY TEST JUMPER KIT II

Set Makes Testing Relays or Live Circuits Quick and Easy on Additional Applications.

Set includes four jumpers to fit many popular relays on Honda, Hyundai, Mitsubishi, Nissan, Toyota, newer Ford and GM mini micro relays as well as International trucks. Simply remove relay to be tested, insert correct jumper and insert relay into jumper. When using grey four pin jumper be careful to align pins on jumper and relay correctly. No need to pierce wires or connect multiple jumper wires. Jumpers have tabs for clamping and flat pads to place test leads on.

60610 Relay Test Jumper Kit II. Molded Case. Shipping wt. 9 oz.

60620 Orange Jumper	60630 White Jumper
60640 Purple Jumper	60650 Grey Jumper



U.S. Pat No. 6,724,193

ELECTRICAL

64750 11 PC. BACK PROBE KIT 64900 17 PC. BACK PROBE KIT

Straight and Angled Back Probe Pins with Standard Banana Plug Connections.

Straight, 45°, and 90° back probe pins with 4mm standard female banana plug connectors. Angled probes for accessing hard-to-reach connectors. No need to disconnect the terminal and connector. Alligator clips with 4mm male banana connectors provide a connection to multimeter probes. The probes are fully insulated, providing added protection. 64750 contains .027 diameter pins. 64900 adds six .040 diameter pins. For use up to 30 volts.

64750 11 pc. Back Probe Kit. Clam Shell. Shipping wt. 2 oz.

64900 17 pc. Back Probe Kit. Clam Shell. Shipping wt. 3 oz.

64760 .027 Straight Red Probe	64770 .027 Straight Green Probe
64780 .027 Straight Yellow Probe	64790 Male 4mm Banana Alligator Clip (2)
64800 .040 Straight Blue Probe	64810 .040 Straight Black Probe
64820 .027 45° Red Probe	64830 .027 45° Green Probe
64840 .027 45° Yellow Probe	64850 .040 45° Blue Probe
64860 .040 45° Black Probe	64870 .027 90° Red Probe
64880 .027 90° Green Probe	64890 .027 90° Yellow Probe
64910 .040 90° Blue Probe	64920 .040 90° Black Probe



64750 Includes:

64760	64770	64780
64790 (2)	64820	64830
64840	64870	64880
64890		



64900 Includes:

64760	64770	64780	64790 (2)
64800	64810	64820	64830
64840	64850	64860	64870
64880	64890	64910	64920



65150 FLEXIBLE BACK PROBES

Flexible Silicone Probe Bends up to 180° for Hard-to-Reach Areas.

Great for checking harness connectors and sensor wiring. No need to disconnect the terminal and connector. The probes are fully insulated which provides added protection. With standard 4mm female banana plug connections. For use up to 30 volts. Wire probe is .038" diameter.

65150 Flexible Back Probes. Clam shell. Shipping wt. 2 oz.

65130 Flexible Back Probe, Red (x2)

65140 Flexible Back Probe, Black (x2)

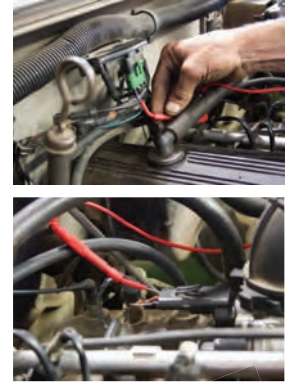
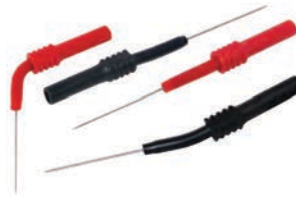

64970 PARASITIC DRAIN TESTER

Provides an Easy Way to Connect a Multimeter to the Vehicle Electrical System to Diagnose Hidden Battery Drain.

Replaceable in-line fuses protect both the meter and tester in the event a high current source on the vehicle is left on. The multimeter is bypassed with the switch during connection in case of a power surge. The tester and meter can remain connected until other computer systems shut down, isolating the drain. As a convenience, stacking banana connectors are used on the tester. This allows voltage to be measured on various locations on the vehicle during the drain test using standard test leads.

64970 Parasitic Drain Tester. Hang Card. Shipping wt. 4 oz.



U.S. Pat No. 9,928,938

46950 RELAY PULLER PLIERS

Pliers for Removing Electrical Relays on Most Domestic and Import Vehicles.

Offset handle and thin tips allow access to relays in confined areas. Specially designed tips are angled to fit slots or edge of relay cover. This allows relay to pop free from socket with less chance of damaging the relay. Also works on many heavy-duty and industrial applications.

46950 Relay Puller Pliers. Skin-Packed. Shipping wt. 5 oz.

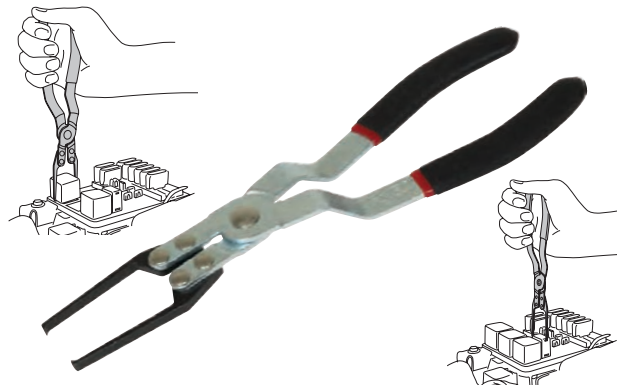

U.S. Pat No. D596,910

13120 ELECTRICAL CONNECTOR SEPARATOR

Quickly Disconnects Electrical Connectors Without Damage.

Engage the tool tip behind the connector clip. Push or pull to disconnect. The tool is double-ended to fit different access angles. Works on Weather Pack and other automotive electrical connectors.

13120 Electrical Connector Separator. Skin-Packed. Shipping wt. 3 oz.

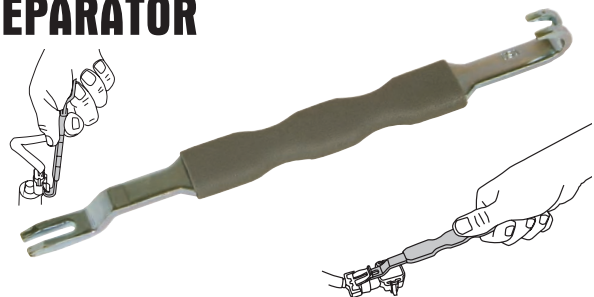

82600 CAT III DIGITAL MULTIMETER

Safely and Accurately Test Electrical Systems.
Large, Easy to Read LCD Display with Backlight.
 Measures AC/DC voltage/current up to 600V and 10A, capacitance, diode, duty cycle, frequency, resistance, temperature and transistor. Includes 13 Functions and an operating temperature range between -40° to 1000°C. Features manual or auto shutdown after 15 minutes of inactivity, protection against overload at all ranges, data hold, low battery indicator and warning alarm. Also includes a LED flashlight for low light situations. Rubber outer case adds protection against drops and a stand bracket to hold meter at viewing angle and test probe holding clips. Test leads, sensor probe and AAA batteries are included.

82600 Digital Multi Meter CAT III. Box. Shipping wt. 11 oz.



82650 MULTIMETER ACCESSORY KIT

Extend Multimeter Capabilities.
 Interchangeable probes for a wide range of testing possibilities. Compatible with most multimeters and scopes with standard 4mm connectors. Kit includes 43" long 4mm banana test leads with straight and 90° connections, test probes, long back probes, safety test probes, crocodile clips, female-to-female adaptors, male-to-female adaptors, small alligator clip with male banana and slotted ring adapters. Includes roll-up storage pouch to keep leads and adaptors organized.

82650 Multimeter Accessory Kit. Hang Card. Shipping wt. 12 oz.

64790 Small Gator Male, Black	82670 Long Probe .040, Black
82680 Long Probe .040, Red	82690 Test Probe 2mm, Black
82700 Test Probe 2mm, Red	82710 Crocodile Clip, Black
82720 Crocodile Clip, Red	82730 F-F Connector, Black
82740 F-F Connector, Red	82750 Forked Connector, Black
82760 Forked Connector, Red	82770 M-F Connector, Black
82780 M-F Connector, Red	82790 Pierce Probe 6", Black
82800 Pierce Probe 6", Red	82810 Test Lead 43", Black
82820 Test Lead 43", Red	82850 Small Gator Male, Red
82860 Roll-up Pouch, Black/Clr	



26250 LOW CIRCUIT TESTER

Quick Check Both AC and DC Current Up to 12 Volts with Power On.

Helps locate shorts or breaks in wiring. Complete with insulated grounding clip.

26250 Low Circuit Tester. Skin-Packed. Shipping wt. 3 oz.

26270 Replacement Bulb

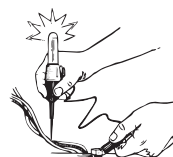

28830 DIGITAL CIRCUIT TESTER 3-49V

Heavy-Duty Circuit Tester with Digital LCD Display to Accurately Show DC Voltage.

Operating range of 3-49 volts DC to work on most vehicle electrical systems. Two LEDs provide 360° visibility of polarity. The red light indicates positive polarity, green indicates negative polarity. Long, 12ft. coil cord and heavy-duty alligator clamp for secure connections. The probe is insulated to prevent the possibility of shorting the side of the probe to other components. Computer safe. Will not damage sensitive electronic components. Not for use on airbags.

28830 Digital Circuit Tester 3-49V. Plastic Tube. Shipping wt. 8.5 oz.



YouTube

U.S. Pat No. 9,970,965

29050 DIGITAL CIRCUIT TESTER 3-30V

Circuit Tester with Digital LCD Display to Accurately Show DC Voltage.

Two LEDs provide 360° visibility of polarity. The probe is insulated to prevent the possibility of shorting the side of the probe to other components. Computer safe. Will not damage sensitive electronic components. Not for use on airbags. Operating range 3-30 volts DC to work on most vehicle electrical systems. 47" cord and heavy-duty alligator clamp for secure connections.

29050 Digital Circuit Tester 3-30V. Skin-Packed. Shipping wt. 5 oz.

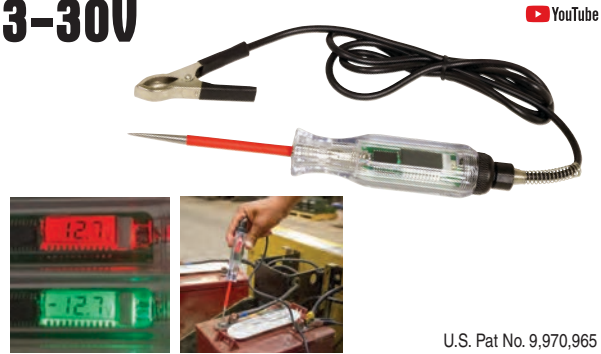

YouTube

U.S. Pat No. 9,970,965

27430 24 VOLT HEAVY-DUTY CIRCUIT TESTER

Quickly Tests Voltage up to 28 Volts.

Works on any circuit up to 28 volts including many heavy duty applications on large trucks and farm implements. Heavy duty probe, cord and clamp. The probe is insulated with high-visibility shrink tubing to prevent the possibility of shorting the side of the probe to other components. Comes with a strain relief spring on the cord.

27430 24 Volt Heavy-Duty Circuit Tester. Skin-Packed. Shipping wt. 8 oz.

27460 24 Volt Bulb



32900 HEAVY DUTY CIRCUIT TESTER / JUMPER

A 2-in-1 Tester that Tests Circuits up to 12 Volts and Works as a Jumper Wire for Power or Ground.

Heavy-duty circuit tester for checking low voltage up to 12 volts. By depressing the red button the tester becomes a jumper for powering electrical components or a ground. The probe, handle, cord and clamp are reinforced for durability. Comes with a strain relief spring on the cord.

32900 Heavy Duty Circuit Tester / Jumper. Skin-Packed. Shipping wt. 7 oz.

28440 Replacement Bulb

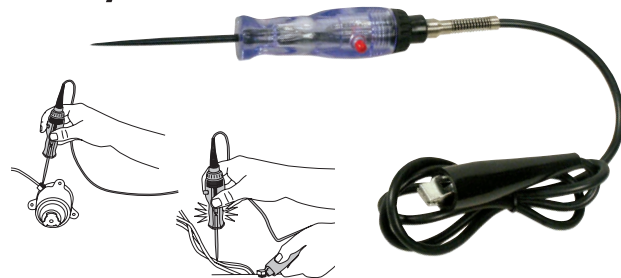

25600 "HANDY HOOKER" CIRCUIT TESTER

Hooded Probe Protects Your Fingers and Automatically Centers the Wire.

Small size allows easy use even in the tightest places. Quickly test low voltage up to 12 volts. Alligator clip grounds tester.

25600 Circuit Tester. Skin-Packed. Shipping wt. 3 oz.

28440 Replacement Bulb



28400 HEAVY DUTY CIRCUIT TESTER

Quickly Tests Low Voltage up to 12 Volts.

A heavy duty circuit tester for lifetime use. The probe, handle, cord and clamp are reinforced for extra durability. Comes with a strain relief spring on the cord.

28400 Heavy Duty Circuit Tester. Skin-Packed. Shipping wt. 7 oz.

28440 Replacement Bulb



24550 COMPUTER SAFE CIRCUIT TESTER

Also Indicates Polarity.

Safe for automotive computers. Won't damage sensitive electronic components. Draws less than 21 mA. at 12 volts DC. Operating range 3-28 volts. The red light indicates positive polarity, green indicates negative polarity.

24550 Computer Safe Circuit Tester. Skin-Packed. Shipping wt. 6 oz.

24560 Replacement Bulb



28620 CIRCUIT TESTER WITH BUZZER

Heavy-Duty Tester Signals with a Light and a Buzzer.

Tests low voltage up to 28 volts. Spring loaded hook can be removed to use the probe tip only. Can also be used to check polarity and battery drain.

28620 Circuit Tester with Buzzer. Skin-Packed. Shipping wt. 10 oz.

Supersedes 28640



ELECTRICAL

32150 POWER / GROUND OUTLET

Provides a Convenient Electrical Ground and Power Source from the Vehicle.

Plug the tool into the cigarette lighter or power accessory receptacle. You now have a ground and power source on the dash. The plug light will come on to signal the plug is properly connected and both power and ground are available at the posts. For power, connect to the positive (+) terminal. For electrical ground, attach ground wire from the instrument to be grounded to the negative (-) terminal.

32150 Power/Ground Outlet. Skin-Packed. Shipping wt. 3 oz.

26270 Replacement Bulb

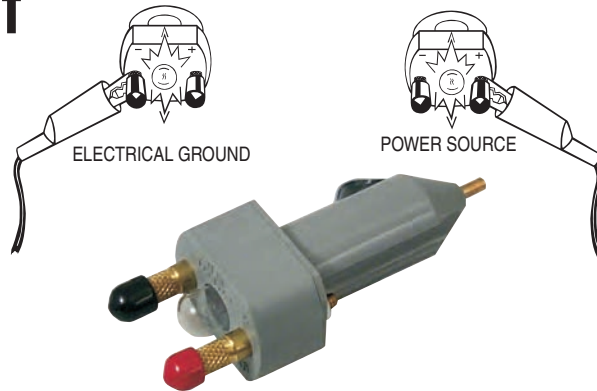

61030 WIRE INSERTION TOOL SET

Includes 1/4" O.D. and 3/8" O.D. Wire Insertion Tools for Use When Installing Wires for Audio Electronics, Aftermarket Lighting, Alarm Systems and Much More.

With a sharp point on the end and palm size handle, these tools provide extra leverage to pierce through firewalls, rubber grommets and panels. The 10-1/2" steel tube provides easy access to feed wires through the firewall. Tools are available individually.

61030 Wire Insertion Tool Set. Skin-Packed. Shipping wt. 10 oz.

60950 1/4" Wire Insertion Tool

60960 3/8" Wire Insertion Tool

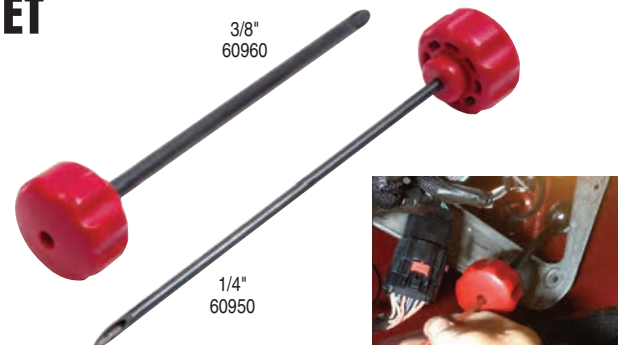

68250 68280 COMPACT MULTI-FUNCTION WIRE STRIPPER 14-24 & 8-14 GAUGE

Cuts and Strips Insulation from 14 to 24 and 8 to 14 Gauge Wires.

68250 Crimps 14 to 24 gauge and 68280 Crimps 8-14 gauge insulated and non-insulated terminals. The pliers end grabs wire for twisting and holding. A convenient wire gauge key is marked on the tool.

68250 Multi Wire Stripper 14-24. Skin-Packed. Shipping wt. 6 oz.

68280 Multi Wire Stripper 8-14. Skin-Packed. Shipping wt. 6 oz.



68220 SELF-ADJUSTING WIRE STRIPPER

Automatically Adjusts to Strip Insulation from 10 to 24 Gauge Wire.

Crimps insulated and non-insulated terminals from 10 to 22 gauge and 7 to 8mm ignition terminals with a size key marked on the tool. Built in wire cutter and gripper force adjustment knob. Comfortable handles and steel construction for durability.

68220 Self-Adjust Wire Stripper. Skin-Packed. Shipping wt. 6 oz.



68430 WIRE STRIPPER, 6"

Features a 3/8" Scissor Style Cutting Blade. Serrated Nose Jaws Strip Seven Wire Sizes which Include 10-22 AWG Wires.

It features a 6" length with pliers on the nose for looping wire. The comfortable grips and spring loaded action make stripping and cutting wire a quick and easy job. A safety lock for protection when the job is finished and ready to be stored.

68430 Wire Stripper, 6". Skin-Packed. Shipping wt. 4 oz.



68440 WIRE STRIPPER/CUTTER/CRIMPER

Curved Cutter at the Front Requires less effort to Cut Wire & Reach into Tight Places.

Crimps 10-22 AWG insulated and non-insulated terminals and 7-8mm automotive terminals. Six screw cutting/sizing stations which offer excellent leverage required to shear. Sizes included are 10-24, 6-32, 8-32, 10-32, 4-40 and 5-40. The nose of the pliers works well for pulling wire, working small nuts and has a hole for looping wire.

68440 Wire Stripper/Cutter/Crimper. Skin-Packed. Shipping wt. 6 oz.



68450 WIRE CRIMPER/CUTTER/STRIPPER

Cutter located at the Front is Ideal for Hard to Reach and Confined Situations.

Five screw cutting/sizing stations are located near the pivot point and require less effort when shearing bolts. Strip 8-18 gauge solid and 10-22 gauge stranded wire and crimp 10-22 AWG insulated & non-insulated connectors. There is a cutter behind the pivot when needed to cut tough and heavy wire.

68450 Wire Crimper/Cutter/Stripper. Skin Pack Card. Shipping wt. 7 oz.



55000 MAGNETIC SOLDERING CLAMP

Offers an Extra Pair of Hands When Soldering.

Alligator clamps firmly hold wire and small parts when soldering. Flexible design allows different ways to attach and hold wire. Clips and base are magnetic and can be attached to any ferrous surface. Magnetic arms can be removed and used without the base. Base is also hex shaped and can fit in a vise when needed.

55000 Magnetic Soldering Clamp. Skin-Packed. Shipping wt. 3 oz.

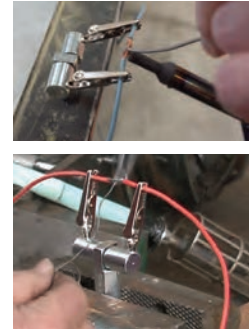

57750 WIRE TERMINAL TOOL KIT

Set of Three Terminal Tools and Handle for Removing Wires from Terminals Without Damage.

Terminal tools work on conventional terminals as well as Pack-Con and Weather-Pack terminals found on many GM vehicles. Blue terminal tool fits many Ford applications. The handle slips over the probes to protect the technician's hand as well as provide extra leverage. All terminal tools are available individually Skin-Packed.

57750 Wire Terminal Tool Kit. Molded Case. Shipping wt. 12 oz.

14900 Terminal Tool for GM

56500 Terminal Tool

57780 Terminal Tool for Ford

57790 Handle

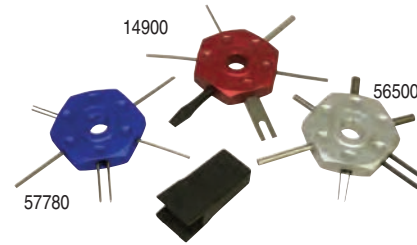

14900 56500 57780 WIRE TERMINAL TOOLS

Eliminate Damaged Wires and Terminals.

Lisle Wire Terminal Tools are designed to remove wires from terminals without damage to either. 56500 prongs depress the "barbs" on conventional terminals. 14900 is designed for Pack-Con and Weather-Pack terminals on GM C3 Systems. Tool can also retrieve trouble codes from engine computer on late model GM vehicles. 57780 fits many Ford applications.

14900 Wire Terminal Tool - Conventional. Skin-Packed. Shipping wt. 2 oz.

56500 Wire Terminal Tool - Pack-Con/Weather Pack.

Skin-Packed. Shipping wt. 2 oz.

57780 Wire Terminal Tool - Ford. Skin-Packed. Shipping wt. 2 oz.

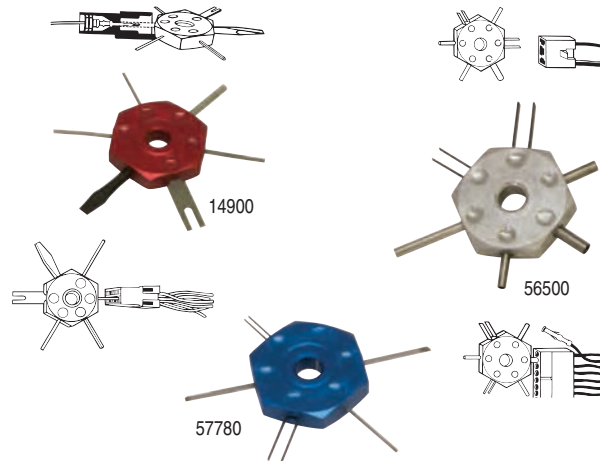

55480 CABLE SLITTER

Removes and Slits Insulation on Single and Multiple Conductor Cables up to 1.25" OD.

An adjustable blade allows for variable insulation thickness up to .187". The tool is 5-1/4" long and features a fiberglass-reinforced nylon body.

55480 Cable Slitter. Box. Shipping wt. 5 oz.

55490 Cable Slitter Blade



17300 FLEXIBLE HOSE CLAMP TOOL

24" Flexible Cable Allows Access to Clamps Difficult to Reach with Other Tools.

Specially designed cable assembly with spring helps prevent cable breakage from over tightening. Tool is very strong and will work on even the most stubborn clamps. For use on clamps found on radiator hoses, heater hoses, and fuel lines. Simply squeeze the handles to expand and hold hose clamps in any open position. Expands hard-to-reach flat-band and Mobeax-type hose clamps safely and easily.

17300 Flexible Hose Clamp Tool. Hang Card. Shipping wt. 1 lb. 9 oz.

17400 Cable and Clamp Assembly



Patent Pending

YouTube

17460 17480 CURVED AND STRAIGHT HOSE CLAMP PLIERS

Cross-Cut Tip Design that Grip Most Hose Clamps from Multiple Angles.

17460 has an ergonomic curved design making pliers easy to use in hard-to-reach areas. Both 17460 and 17480 have a cross-cut tip design that grip most hose clamps from multiple angles. Ratcheting lock mechanism holds the clamp in an open position for hands-free use. Dual material grips for comfort. Works on most spring hose clamps.

17460 Curved Hose Clamp Pliers. Skin-Packed. Shipping wt. 1 lb. 3 oz.

17480 Straight Hose Clamp Pliers. Skin-Packed. Shipping wt. 1 lb. 5 oz.



Patent Pending

YouTube

55230 CLIC® & CLIC-R® CLAMP PLIERS

Designed to Easily Remove and Install Clic® and Clic-R® Hose Clamps Found on Many European Vehicles.

Durable forged construction and dual material grips for comfort. Double-sided tool for removing and installing clamps without damage so they can be reused. Integrated spring makes tool easier to use. Arrows on tool indicate proper use.

55230 Clic-R® Clamp Pliers. Skin-Packed. Shipping wt. 10 oz.



REMOVE



INSTALL



YouTube

67000 MASTER LINE STOPPER SET

For Internal and External Lines.

The set includes four stoppers to seal lines in automotive flare type steel brake lines, power steering and transmission cooler lines. Two line clamp pliers 6-1/4" and 7-1/4" in length seal flexible brake lines, fuel and vacuum lines. Smooth rounded edges will not damage internal hose reinforcement. Eight stoppers and four caps are used for plugging vacuum and fuel lines. Stepped design can be used for both internal and external lines. Stopper sizes from 1/8" through 1/2". Caps are 5/8" and 3/4" for larger lines.

67000 Master Line Stopper Set. Molded Case. Shipping wt. 2 lbs. 1 oz.

67030 Line Stopper 1/8" (2)

67040 Line Stopper 3/16"-1/4" (2)

67050 Line Stopper 5/16"-3/8" (2)

67060 Line Stopper 7/16"-1/2" (2)

67070 Line Stopper Cap 5/8" (2)

67080 Line Stopper Cap 3/4" (2)

67090 Line Clamp Pliers Small

67100 Line Clamp Pliers Medium

67110 Steel Line Stopper 1/4"

67120 Steel Line Stopper 5/16"

67130 Steel Line Stopper 3/8" Banjo

67140 Steel Line Stopper 3/8"



17370 35 DEGREE LONG HOSE CLAMP PLIERS

Provides an Extra Long Reach and 35° Angled Tips for Hard-to-Reach Hoses.

Cross-cut tip design grips most hose clamps from multiple angles. Ratcheting lock mechanism holds the clamp in an open position for hands-free use. Dual material grips for comfort.

17370 35 Degree Hose Plier. Hang Tag. Shipping wt. 1 lb. 7 oz.



17000 LONG REACH HOSE CLAMP PLIERS

Overall Tool Length of 17" Provides Extra Long Reach.

Cross-cut tip design grips most hose clamps from multiple angles. Ratcheting lock mechanism holds the clamp in an open position for hands-free use. Dual material grips for comfort.

17000 LR Hose Clamp Pliers. Hang Tag. Shipping wt. 1 lb. 6 oz.



HOSE

17100 FLAT BAND HOSE CLAMP PLIERS

Adjustable Jaws Fit All Clamp Sizes for Easy Removal and Installation.

This tool removes and installs flat band hose clamps used on heater and radiator hoses. Tips screw in and out to fit all clamp sizes. Ratcheting lock mechanism holds the clamp in an open position for easy removal and installation. Tips can be switched to accommodate different applications. Offset jaws allow access in hard-to-reach areas.

17100 Flat Band Hose Clamp Pliers. Skin-Packed. Shipping wt. 1 lb. 1 oz.

17120 Hollow Tip

17220 Slotted Tip

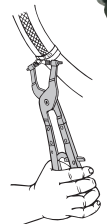

OFFSET JAWS ALLOW ACCESS TO HARD-TO-REACH AREAS



EXTEND TIP POSITION FOR SMALLER CLAMPS



TIP POSITION FOR BIGGER CLAMPS

44480 44500 HOSE CLAMP VISES

Vise Design Fits in Tight Spots. 44500 is 3" Long and Opens to 1-1/2". 44480 is 3-5/8" Long and Opens to 2-1/8".

Tool are used to relieve clamp spring pressure in very tight spots. Vise is often left in place, with the clamp compressed. Ramp on jaws guides tab of clamp into correct position and traps it in the slot for safety. Tighten knurled knob by hand or use 1/4" drive ratchet. Can also be used on round wire clamps found on Detroit Diesel applications.

44480 3" Hose Clamp Vise. Skin-Packed. Shipping wt. 5 oz.

44500 3-5/8" Hose Clamp Vise. Skin-Packed. Shipping wt. 5 oz.

44480

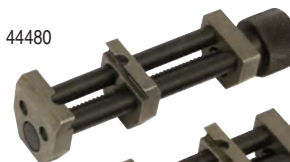

44500

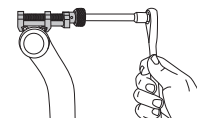
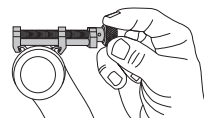
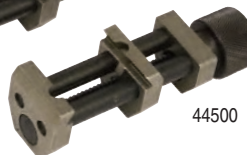

11420 HOSE CUTTER

Cuts Flexible Hose up to 1-1/4".

The Hose Cutter will cleanly cut heater hoses, fuel lines, and other types of flexible hose up to 1-1/4". The stainless steel blade is reversible for double the life. Plier is made of glass-filled nylon for strength.

11420 Hose Cutter. Skin-Packed. Shipping wt. 11 oz.

11450 Replacement Blade



47900 HOSE REMOVER PLIERS

For Easy Removal of 5/32" to 1/2" Vacuum and Fuel Hoses.

Engage the tube (line) with the black jaw. This sharpened jaw actually "DIGS" into the tube to grip it! Squeeze and the hose is easily pushed off by the silver jaw.

47900 Hose Remover Pliers. Skin-Packed. Shipping wt. 7 oz.

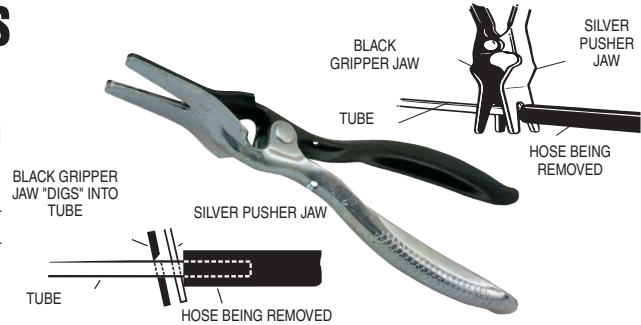

22850 HOSE PINCHERS

A quick, easy way to pinch off vacuum lines, fuel lines, brake lines, etc. without damaging the line. Sold two per set.

22850 Hose Pinchers. Skin-Packed. Shipping wt. 5 oz. (2 per set)



23000 HOSE PINCHER

Clamps And Holds Hoses Up To 3/4" I.D.

Angled jaws close to create a complete seal every time. Jaws are offset for hard-to-reach areas. The handles lock firmly to hold the jaws in a closed position. Frees both hands to do the work. Used on brake hoses, vacuum hoses, heater hoses and all flexible rubber hose. Made of glass-filled nylon for extra strength.

23000 Hose Pincher. Skin-Packed. Shipping wt. 6 oz.

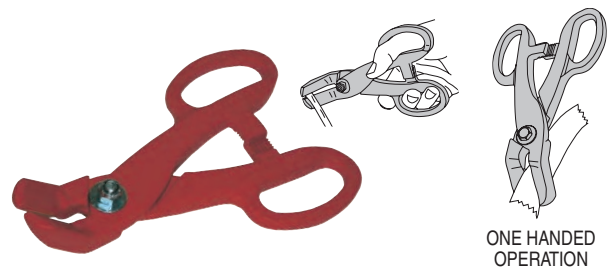

67500 67600 SMALL & MEDIUM HOSE PINCHERS

Features a Mechanism for Clamping without Springs or Any Manual Adjustments.

The 5-1/2" small hose pinchers clamp down on coolant, fuel and vacuum lines up to 3/4" O.D. Can be useful in hard-to-reach areas and to clamp on smaller hoses or lines. The 9-1/4" medium hose pinchers squeeze radiator and heater hoses shut and clamp down on lines up to 1-1/4" O.D.

67500 Small Hose Pinchers. Skin-Packed. Shipping wt. 3 oz.

67600 Medium Hose Pinchers. Skin-Packed. Shipping wt. 13 oz.

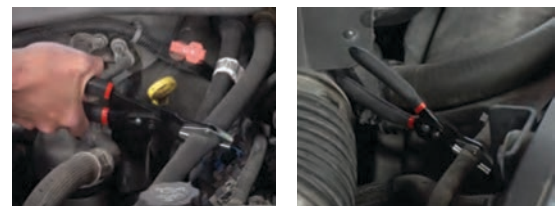

YouTube

80380 HOSE REMOVER SET, 5 PC.

Set of Five Hose Removers with Many Uses.

Contains long and short, standard and offset hooks. Can be used to remove hoses, moldings, clips, clamps, seals, o-rings, cotter pins, gaskets, etc. Long pullers are 13" long. Handles are dual material for comfort and grip. Rods are heat-treated for strength and plated for durability. All hose removers are available individually Skin-Packed.

80380 Hose Remover Set, Skin-Packed. Shipping wt. 1 lb. 4 oz.

80210 Short Hose Remover 80220 Long Hose Remover

80230 Short Offset Remover 80240 Long Offset Remover

80290 Short Double Offset Remover

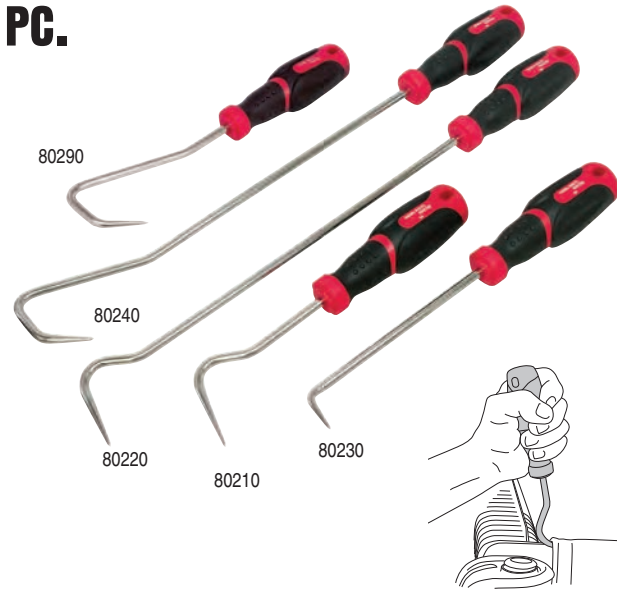

HOSE

82130 RADIATOR HOSE SPOON SET, 2 PC.

Designed to Remove Radiator Hoses from Fittings.

Flat and wide blades reduce the chance of damage when removing. The long blade is used for pulling the hose off, while the short blade is designed for pushing. Handles are dual material for comfort and grip. Heat-treated for strength.

82130 Radiator Hose Spoon Set, 2pc. Skin-Packed. Shipping wt. 10 oz.

82140 Radiator Hose Spoon, Short 82150 Radiator Hose Spoon, Long



18700 HOT SLEEVE

Protects Arms from Burns While Working Around the Engine.

Made of durable, heat-resistant Kevlar®. Double wall construction for added heat protection. Will protect hand and forearm from hot objects. Will work on either right or left arm. Sleeve is washable.

18700 Hot Sleeve. Hang Card. Shipping wt. 3 oz.

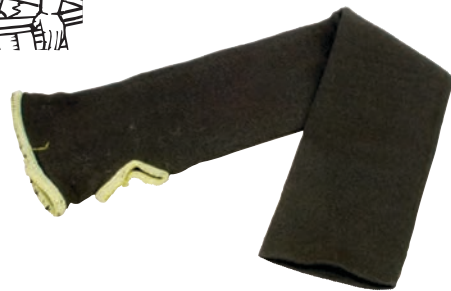

GENERAL

21260 ARM GLOVE

Total Hand and Arm Burn Protection.

The heat resistant Kevlar® material protects hands and arms from hot surfaces. This enables work on hot engines and exhaust systems without waiting. Works on both right and left hands. The glove portion is coated with a vinyl tread for greater gripping power. Extends to 24". Washable.

21260 Arm Glove. Hang Card. Shipping wt. 37 oz.



31750 MINI HOOK AND PICK SET, 4 PC.

YouTube

Works Great for Removing Hoses, Moldings, Clips, Clamps, Seals, O-Rings, Cotter Pins, and Gaskets. Includes hook pick, straight pick, 90° pick and combination pick. Small enough for maximum versatility in tight and hard-to-reach places. Dual material handles with heat treated tips for durability.

31750 Mini Hook & Pick Set. Skin-Packed. Shipping wt. 5 oz.

31770 90 Degree Mini Pick 31780 45 Degree Mini Pick

31810 Awl / Straight Mini Pick 31830 Curved Mini Hook



89900 89910 89920 MECHANICS GLOVES

A Mechanics Glove with Extended Life, Non-Padded, Single Layer Palm and Tough Expandable Top Material.

Hidden seam design and elastic cuff, with hook and loop fastener, for comfort. Touch screen compatible design for use with many smart phones, tablets and touch screen computers.

89900 Mechanics Glove. Medium. Hang Card. Shipping wt. 5 oz.

89910 Mechanics Glove. Large. Hang Card. Shipping wt. 5 oz.

89920 Mechanics Glove. X-Large. Hang Card. Shipping wt. 5 oz.



89950 89960 89970 HEAVY DUTY IMPACT GLOVES

A Heavy Duty Impact Glove with 3mm Gel Palm Padding and Molded Knuckle Protection.

Gel palm padding to help absorb vibration from impact and power tools. Extra protection molded on glove back and fingers. Hidden seam design and elastic cuff, with hook and loop fastener, for comfort. Touch screen compatible for use with many smart phones, tablets and touch screen computers.

89950 Heavy Duty Impact Gloves. Medium. Hang Card. Shipping wt. 6 oz.

89960 Heavy Duty Impact Gloves. Large. Hang Card. Shipping wt. 6 oz.

89970 Heavy Duty Impact Gloves. X-Large. Hang Card. Shipping wt. 6 oz.



GENERAL

59000 RATCHETING SERPENTINE BELT TOOL

Releases Tension on Serpentine Belts With a Spring Loaded Idler Pulley.

Ratcheting head with freewheel position allows maximum leverage. Set ratcheting head to the middle or neutral/ freewheel position and once maximum travel point is reached simply click lever into place to lock the ratchet mechanism. Comes with extension for hard-to-reach idler pulleys. This tool will work where conventional ratchets or breaker bars won't fit due to limited access. Includes 19mm socket for Honda and Toyota applications.

59000 Ratcheting Serpentine Belt Tool. Skin-Packed. Shipping wt. 2 lbs. 10 oz.

57520 Socket Set.

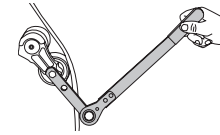

Part #	Description
57390	14mm Socket
57440	15mm Socket
57450	18mm Socket
57500	13mm Socket
57530	3/8" Square Drive
57560	1/2" Square Drive
57580	16mm Socket
59100	Extension
59140	19mm Socket
59190	Handle Assembly

59800 SERPENTINE BELT TOOL

Releases Tension on Serpentine Belts With a Spring Loaded Idler Pulley.

This tool is used to remove and install belts on serpentine belt systems using the spring loaded idler pulley. For applications with limited access, 13mm and 16mm sockets are built into the handle. This tool covers most domestic and some import applications. Comes with extension for hard-to-reach idler pulleys. Eight low profile sockets and extension help to fit into tight spots. Includes 19mm socket for Honda and Toyota applications.

59800 Serpentine Belt Tool. Skin-Packed. Shipping wt. 2 lbs. 4 oz.

57520 Socket Set.

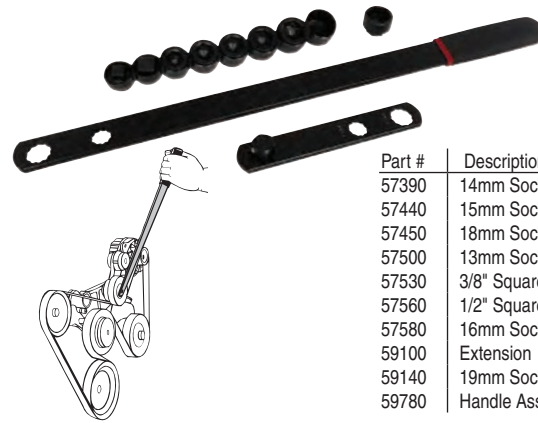

Part #	Description
57390	14mm Socket
57440	15mm Socket
57450	18mm Socket
57500	13mm Socket
57530	3/8" Square Drive
57560	1/2" Square Drive
57580	16mm Socket
59100	Extension
59140	19mm Socket
59780	Handle Assembly

31920 O-RING REMOVER TOOL SET, 4PC.

Rounded Tips for Easy, Damage-Free Removal of Seals and O-Rings.

Two tip configurations and two blade lengths to work on most applications including oil pump drive shaft seals, injectors and fuel rail O-rings. Also removes inner tie rod rack boot, CV boot, heater and vacuum hoses. Dual material grip handle for comfort.

31920 O-Ring Remover Tool Set. Skin-Packed. Shipping wt. 4 oz.

31940 Short O-Ring Remover

31950 Long O-Ring Remover

31980 Short Offset O-Ring Remover

31990 Long Offset O-Ring Remover

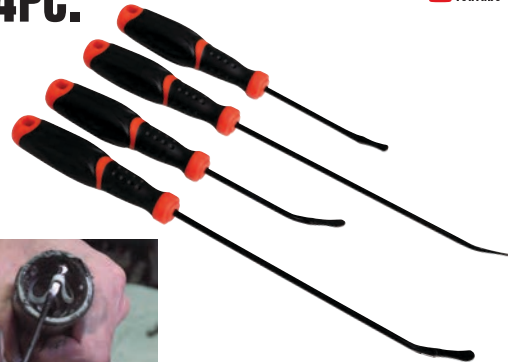

YouTube



31840 "O" RING AND SEAL PICK

Quickly Removes & Installs "O" Rings & Seals.

Tips are angled for hard-to-reach areas typically found around brakes, air conditioning and transmissions. Tips are hardened to stay sharp. Handle is knurled for a sure grip.

31840 "O" Ring and Seal Pick. Skin-Packed. Shipping wt. 2 oz.

31800 SCRIBE

For Marking Metal & Softer Material Surfaces.

Comes with straight and 90° points to mark in even the tightest places. Heat-treated carbon steel points provide durability. Knurled aluminum handle provides a sure grip.

31800 Scribe. Skin-Packed. Shipping wt. 2 oz.

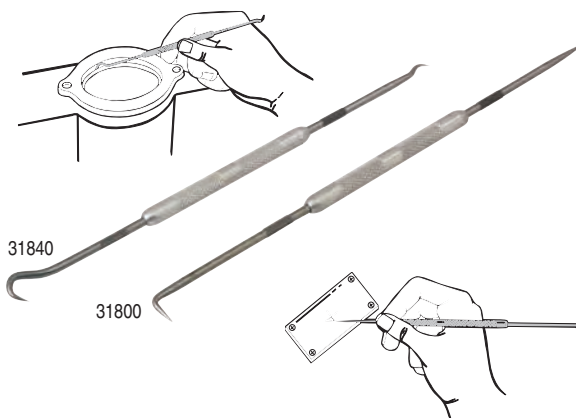

59650 RATCHETING SERPENTINE BELT TOOL KIT

Removes and Installs Belts on Serpentine Belt Systems Using the Spring Loaded Idler Pulley.

Ratcheting head with freewheel position allows maximum leverage. Set ratcheting head to the middle or neutral/freewheel position and once maximum travel point is reached simply click lever into place to lock the ratchet mechanism. Comes with extension for hard-to-reach idler pulleys. This tool will work where conventional ratchets or breaker bars won't fit due to limited access.

59650 Ratcheting Serpentine Kit, 11pc. Molded Case. Shipping wt. 3 lb. 4 oz.

57390 14mm Socket	57440 15mm Socket
57450 18mm Socket	57500 13mm Socket
57530 3/8" Sq. Drive	57560 1/2" Sq. Drive
57580 16mm Socket	59100 Extension
59140 19mm Socket	59190 Handle Assy.
59640 17mm Socket	59660 Case for 59650 & 59670



YouTube



59670 SERPENTINE BELT TOOL KIT

Releases Tension on Serpentine Belts With a Spring Loaded Idler Pulley.

This tool is used to remove and install belts on serpentine belt systems using the spring loaded idler pulley. For applications with limited access, 13mm and 16mm sockets are built into the handle. This tool covers most domestic and some import applications. Comes with extension for hard-to-reach idler pulleys. Nine low profile sockets and extension help to fit into tight spots.

59670 Serpentine Belt Kit, 11 pc. Molded Case. Shipping wt. 3 lb. 7 oz.

57390 14mm Socket	57440 15mm Socket
57450 18mm Socket	57500 13mm Socket
57530 3/8" Sq. Drive	57560 1/2" Sq. Drive
57580 16mm Socket	59100 Extension
59140 19mm Socket	59640 17mm Socket
59660 Case for 59650 & 59670	59780 Handle Assy.



YouTube



48000 ALUMINUM VISE JAW PADS

Ideal for Holding Round and Hex Parts Securely.

V-shaped aluminum surface holds and helps protect round or hex parts. Specially designed ledge supports flat parts while clamping. Strong nitrile magnets will attach to any steel vise jaws. Pad length is 4".

48000 Aluminum Vise Jaw Pads. Skin-Packed. Shipping wt. 7 oz.

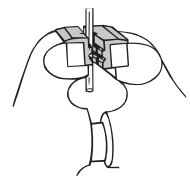
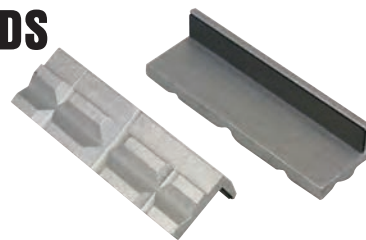

48100 RUBBER FACED VISE JAW PADS

For Protecting Delicate Parts.

Rubber jaw pads protect delicate parts from damage. Also works great for holding irregular shapes. Strong nitrile magnets attach to any steel vise jaw. Pad length is 4".

48100 Rubber Faced Vise Jaw Pads. Skin-Packed. Shipping wt. 7 oz.

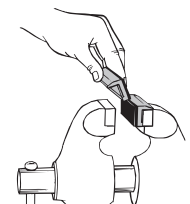

45900 HOOD PROP

Works on All Makes of Cars and Trucks.

The three-piece, telescoping design allows the mechanic to hold the hood in the desired position. The tool telescopes from 18-1/2" to 46-3/4". Can be used from the side of car for better access to the engine compartment. Also great for body or repair work on door, trunk lids, or hatchbacks.

45900 Hood Prop. Skin-Packed. Shipping wt. 2 lbs. 3 oz.

475710 Repair Kit

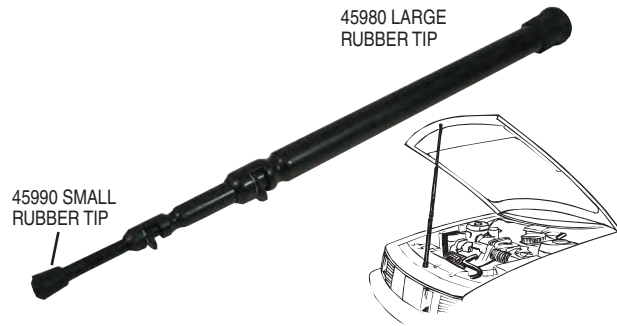

REPAIR KIT 45710 INCLUDES 1 LEVERS AND 2 SPRINGS

46170 HOOD PROP WITH SUPPORT

Includes a Support to Help Prevent Slipping.

The tool includes our standard 45900 Hood Prop plus a support to help prevent the bottom of the tool from slipping. The tool with the support telescopes from 20" to 48-1/4". Place the support over a hood adjuster. Then set the hood prop base into the holding support.

46170 Hood Prop. Skin-Packed. Shipping wt. 2 lbs. 4 oz.

475710 Repair Kit

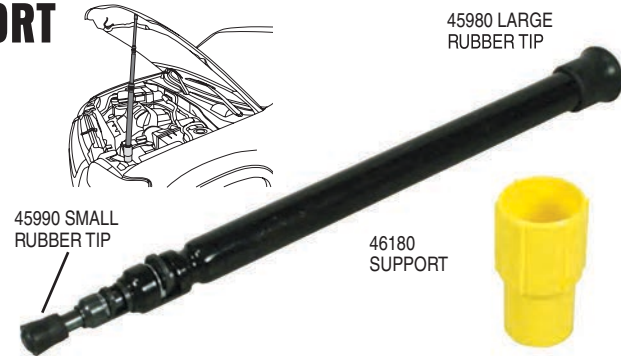

U.S. Pat No. 7,410,142

12050 12060 MASTER CHUCK KEYS

Two Handy Chuck Keys, Each with 4 Sizes.

Both tools have strong neodymium magnets for attachment close to the worksite or toolbox. The eight different chuck key sizes cover the most popular chucks available. Cast from alloy steel for strength.

12050 Small Chuck Key. Skin-Packed. Shipping wt. 4 oz.

12060 Large Chuck Key. Skin-Packed. Shipping wt. 8 oz.

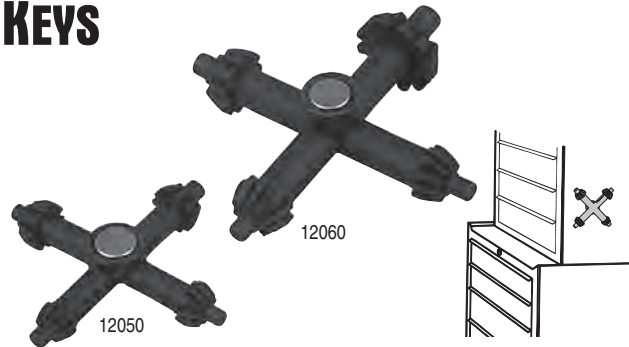

GENERAL

72070 POWER STEERING EVAC KIT

Used to Evacuate Air from the Power Steering System After Service Work has Been Completed.

Includes large tapered stopper, small tapered stopper, graduated catch can, two lids, tubing and three brake bleeder adapters. Use with vacuum pump. Can also be used on clutch reservoirs and brakes.

72070 Power Steering EVAC Kit. Molded Case. Shipping wt. 1lb. 6 oz.

72080 Case for 72070

72090 Canister

72100 Big Stopper

72110 Tapered Stopper

72120 Long Clear Tube

72130 Short Clear Tube

72140 Lid with Inlets

72150 Lid Solid

72160 O-Ring for Lid

72170 Small Brake Bleeder

72180 Medium Brake Bleeder

72190 Large Brake Bleeder



44870 UNIVERSAL LIFT SUPPORT CLAMP

Holds Weak Gas Charged Lift Supports Open.

Tool holds gas charged lift supports found on hoods, tailgates, hatchbacks and trunks. Clamp securely holds weak lift supports in the extended position to allow access to the engine compartment or luggage area. The aluminum body and brass threads prevent damage to the lift support. Colorful flag serves as a reminder to remove the clamp.

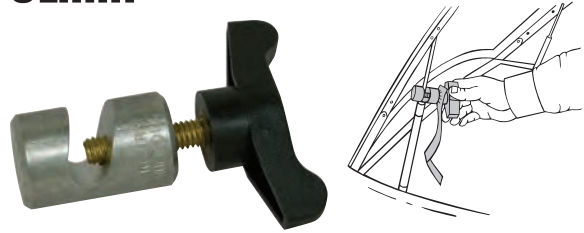

44870 Universal Lift Support Clamp. Skin-Packed. Shipping wt. 4 oz.

70500 TAP SOCKET SET, 8 PC.

For Use in Restricted Areas.

Ideal for use in areas where a T-handle won't fit. Set of 8 sockets fits all number and fractional M.C.T.I. standard taps thru 1/2". Also fits 1/8" NPT taps and metric taps thru 12mm manufactured to M.C.T.I. standards. Convenient vinyl holder. All sockets are available individually.

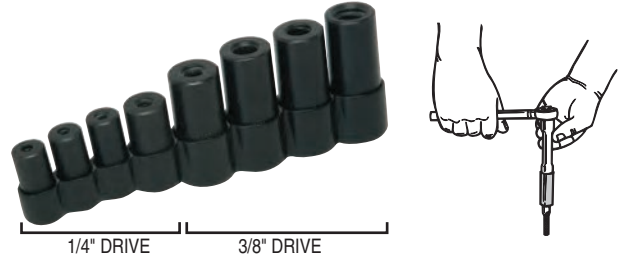

70500 Tap Socket Set, 8 pc. Skin-Packed. Shipping wt. 15 oz.

70500 SET INCLUDES:

Part No.		Fits In.	Fits Metric	Shank Dia.	Sq. Size
70520	Socket #1	#1,2,3,4,6,8	1.6, 1.8, 2, 2.2, 2.5, 3, 3.15, 3.5mm	.141	.110
70540	Socket #2	#8	4mm	.168	.131
70560	Socket #3	#10	4.5, 5mm	.194	.152
70580	Socket #4	1/4"	6, 6.3mm	.255	.191
70600	Socket #5	5/16", 7/16"	7, 8mm	.323	.242
70620	Socket #6	3/8"	10mm	.381	.286
70640	Socket #7	1/2"	12, 12.5mm	.367	.275
70660	Socket #8	1/8" NPT		.437	.328

70940 TAP SOCKET SET, 3 PC.

Three Larger Sizes in a Convenient Set.

Ideal for use where a T-handle won't fit, especially in restricted areas. For larger, fractional M.C.T.I. standard taps. #9 socket is 5/8" (16mm), #10 is for 11/16" (18mm) and #11 is for 3/4". Convenient vinyl holder. All sockets are available individually.

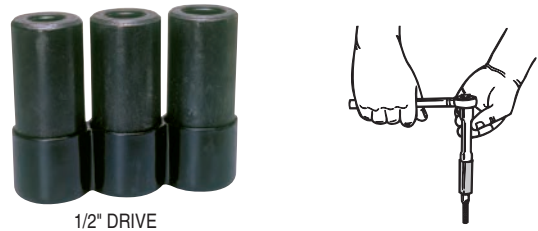

70940 Tap Socket Set, 3 pc. Skin-Packed. Shipping wt. 1 lb. 4 oz..

70940 SET INCLUDES:

Part No.		Fits In.	Fits Metric	Shank Dia.	Sq. Size
70860	Socket #9	5/8"	16mm	.480	.360
70880	Socket #10	11/16"	18mm	.542	.406
70900	Socket #11	3/4"	-----	.590	.442

71670 LARGE TAP SOCKET SET, 5 PC.

Five Larger Sizes in a Convenient Set.

Fit 5/8", 11/16", 3/4", 7/8" and 1" (16mm, 18mm, 22mm and 25mm) taps manufactured to M.C.T.I. standards. Ideal for use in restricted areas where a T-handle won't fit.



71670 Tap Socket Set, 5 pc. Box. Shipping wt. 2 lb. 7 oz.

70860 Tap Socket #9

70880 Tap Socket #10

70900 Tap Socket #11

71680 Vinyl Holder

71700 Tap Socket #12

71720 Tap Socket #13

Socket #	Fits Inch	Fits Metric	Shank Diameter	Square Size
#9	5/8"	16mm	.480	.360
#10	11/16"	18mm	.542	.406
#11	3/4"	-----	.590	.442
#12	7/8"	22mm	.697	.523
#13	1"	25mm	.800	.600

48700 THROTTLE PEDAL DEPRESSOR

Holds Throttle at a Constant RPM.

Engage the nylon hook under the steering wheel. Then extend the depressor rod to the accelerator pedal. Use the adjustment screw to fine-tune the RPM level. Tool is 40" in overall length but can be disconnected for easier storage.

48700 Throttle Pedal Depressor. Skin-Packed. Shipping wt. 1 lb. 7 oz.

48770 Replacement Rubber Tip

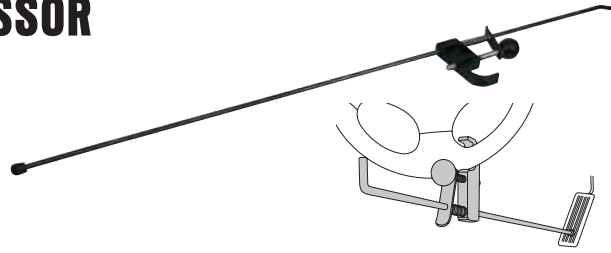

U.S. Pat No. 6,745,653

11770 RADIO REMOVER

Disengages Retaining Clips on Fords and Imports.

Tool quickly releases and locks into retaining clips on radios. Also works on some Saab, VW, Audi, and other import applications. Set also serves as handles for removing the radio from the panel. Also works on some DIN mountings found on import vehicles.

11770 Radio Remover. Skin-Packed. Shipping wt. 1 oz.

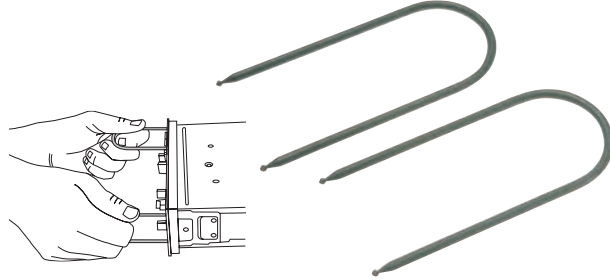

30280 AUTOMATIC CENTER PUNCH

Automatic Firing Action.

Automatic action fires to create a dimple when downward pressure is applied. No hammer is needed. Works on metal, plastic, wood and other materials. Pressure can be varied by turning the knurled knob. Hardened tool steel tip is replaceable. Length 5-1/2".

30280 Automatic Center Punch. Skin-Packed. Shipping wt. 2 oz.

30290 Replacement Tip



GENERAL

89880 NYLON FENDER COVER, RED

Durable Nylon Material Protects Vehicle Finish.

Non-slip rubber backing helps keep cover in place without magnets. Grease, oil and water resistant. Machine washable.

89880 Nylon Fender Cover. Bag. Shipping wt. 10 oz.

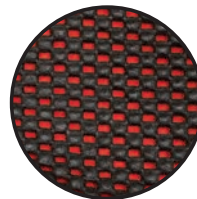

Non-Slip Backing



35070 BUTTON CONNECTOR PLIERS

Disconnects Fuel Line, EVAP Line and DEF Fittings with Tabs that Must be Depressed to Disengage.

Works great on Delphi two tab connectors and some import vehicles. Can also be used on some electrical connectors. 23" cable for hard-to-reach connectors is replaceable. Ratcheting pliers lock in place so two hands can be used to separate connectors. Double-dipped grips for comfort.

35070 Button Connector Pliers. Hang Card. Shipping wt. 1 lb. 3 oz.

35080 Cable for Button Pliers



YouTube

11750 CLUTCH COUPLING REMOVER FOR FORD

Disconnects Ford Hydraulic Clutch Lines.

Easily disengages the hydraulic clutch line from the clutch slave cylinder on some Ford manual transmissions. Tool prongs fit around clutch line above nylon sleeve.

11750 Clutch Coupling Remover for Ford. Skin-Packed. Shipping wt. 2 oz.

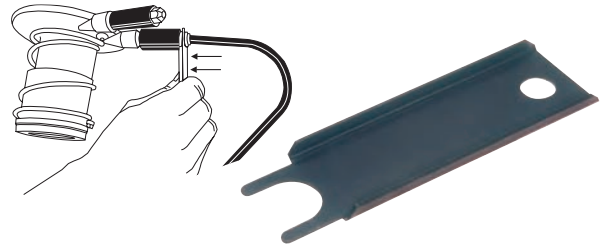

83600 DRILL BITS, 6 PC.

M2 High Speed Steel Drill Bits.

Set includes 2 each of the following jobber length size drill bits: 1/8", 1/4" and 5/16". Each size is housed in a plastic tube for easy storage.

83600 Drill Bits, 6 pc. Hang Card. Shipping wt. 6 oz.

83610 Drill Bits, 1/8". 2 pc.

83600 Drill Bits, 1/4". 2 pc.

83600 Drill Bits, 5/16". 2 pc.



83580 QUICK RELEASE UTILITY KNIFE

Compact Utility Knife with an Ergonomic Comfort Grip to Be Used On Various Jobs.

Features a quick-change blade mechanism for changing blades safely. The safety lock keeps the blade from folding when in use.

83580 Quick Release Utility Knife. Skin-Packed. Shipping wt. 3 oz.



83570 UTILITY BLADES, 5 PC.

Standard, Double-Ended Blades To Fit Most Utility Knives.

Carbon steel blade with precision cutting edge.

83570 Utility Blades, 5 pc. Mini Pouch. Shipping wt. 1 oz.



32050 TELESCOPING MIRROR

Enables You To See Around Corners.

2-1/4" diameter mirror swivels to any position. Telescopes from 6-5/8" to 36-3/8". Textured handle provides sure grip.

32050 Telescoping Mirror. Skin-Packed. Shipping wt. 5 oz.

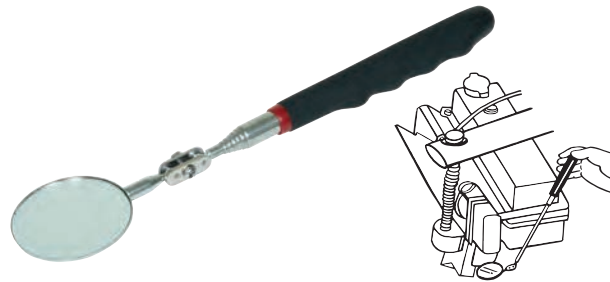

66540 MINI FLEXIBLE MAGNETIC PICK UP TOOL

Super Strong Neodymium Magnet Picks Up All Ferrous Metal Objects Up to 2 lbs.

Adjustable telescoping action extends from 4-1/2" to 13" with a 2-1/2" flexible segment to get into tight spots.

66540 Mini Flexible Magnetic Pick Up Tool. Skin-Packed. Shipping wt. 2 oz.

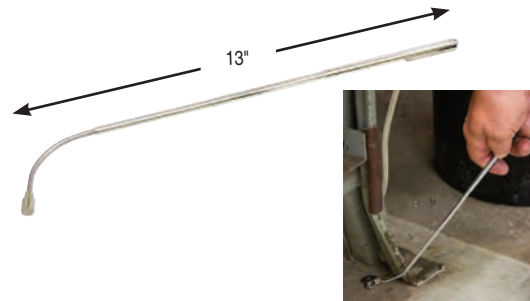

66580 FLEXIBLE 23-1/2" MAGNETIC PICK-UP TOOL

Adjustable Telescoping Action Extends from 5-3/8" to 23-1/2" with a 3-1/2" Flexible Segment that Holds Its Shape.

Super strong neodymium magnet picks up all ferrous metal objects up to 2.5 lbs.

66580 Heavy-Duty Flexible Magnetic Pick-Up Tool. Skin-Packed. Shipping wt. 2 oz.

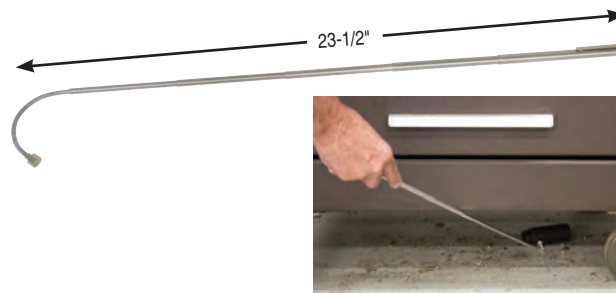

31000 66500 MAGNETIC PICK-UP TOOLS

Will Retrieve Parts and Tools from Hard to Reach Places.

Magnet shielded to concentrate magnetic field at end of tool. 31000 and 66500 have a super strong neodymium magnet. 31000 extends from 14-1/2" to 23-1/4". 31250 total length 9-1/2". 66500 telescopes from 4-1/2" to 16-1/4".

31000 Magnetic Pick-Up Tool. Skin-Packed. Shipping wt. 7 oz.

66500 Telescoping Magnetic Pocket Pick-Up. Skin-Packed. Shipping wt. 2 oz.

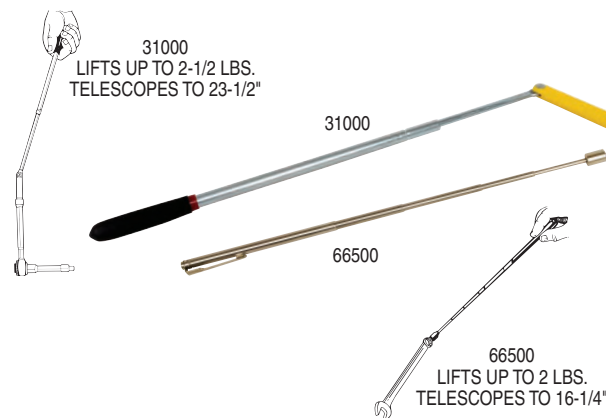

31140 23" FLEXIBLE RETRIEVING TOOL

Picks Up Loose Parts in Hard-To-Reach Areas.

23" flexible cable allows you to get into hard-to-reach areas. Simply push button on handle and fingers open 3/4" to grab small parts that you can't reach by hand.

31140 23" Flexible Retrieving Tool. Hang Card. Shipping wt. 3 oz.



40460 40490 PLIERS & WRENCH RACKS

Keeps Toolboxes Neat and Organized.

By holding pliers and wrenches vertically, tools take up less space in the toolbox while keeping them easy to identify, locate and grab. Thirteen slots hold various shapes and sizes of wrenches and pliers. Ten 5/8" wide slots for narrow tools and three 7/8" wide slots for larger tools. Only 1-5/8" tall. Specially designed slot allows thinner pliers and wrenches to remain vertical. Made of durable molded plastic.

40460 Pliers & Wrench Rack - Black. Hang Card. Shipping wt. 14.2 oz.

40490 Pliers & Wrench Rack - Red. Hang Card. Shipping wt. 14.2 oz.



40460



40490



BEFORE



AFTER

U.S. Pat No. D673,391

20130 MAGNETIC GLOVE DISPENSER

Magnetic Glove Dispenser Conveniently Attaches to Your Toolbox or Any Ferrous Metal Surface.

Two large magnets hold the dispenser in place. Or, mount it on a wall using the screw slots provided. Fits all common sizes of disposable rubber glove boxes, both 50 and 100 packs. The dispenser has 3 adjusting springs which can be adjusted as necessary to hold the various box sizes. Made of powder-coated steel.

20130 Magnetic Glove Dispenser. Boxed. Shipping weight 1 lb. 10 oz.

Available in 6 pack boxes only for product protection.

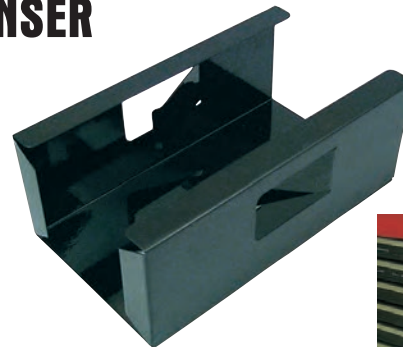

U.S. Pat No. 6,820,753

50350 SIDE WINDER AIR HOSE REEL

Coil & Uncoil Your Air Hose Neatly & Quickly.

The Side Winder Air Hose Reel provides a large 10" diameter reel to prevent tight coils in your air hose. Two built-in tool hangers keeps air chuck, blow gun or other air tools handy. The 1/4" NPT brass swivel keeps air flowing freely & handles up to 250 P.S.I.. A coil spring brake keeps reel from unrolling, yet allows easy dispensing of hose. Versatile installation — can be fastened in any direction — on or under a bench, on a wall, from the ceiling, on a compressor or on a service truck. The all steel construction with durable powder baked paint finish is made to last. Supplies 28 C.F.M. at 90 P.S.I. Reel holds 150 feet of 5/8" O.D. hose or 100 feet of 3/4" O.D. hose. Dimensions: Diameter 17-3/4", Width 11", Height 19".

50350 Air Hose Reel. Box. Shipping wt. 9 lbs. 3 oz.

50310 Swivel Joint

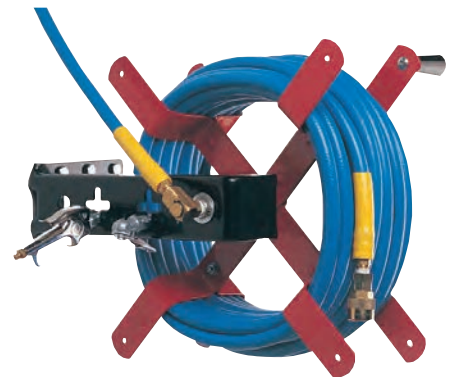

Air Hose and Air Tools Not Included.

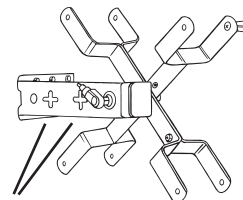

TWO BUILT-IN TOOL HANGERS

40200 40210 3/8" MAGNETIC SOCKET HOLDERS

Organizes 3/8" Fractional & Metric Sockets.

28 socket compartments that allow you to keep your 3/8" standard and deep sockets in one convenient holder. Holds sockets up to 1" or 24mm. Design of holders leaves sockets exposed for easy identification. Powerful magnets securely hold sockets in tray, & tray to any steel surface. Made of strong ABS plastic. Fits most 3/8" sets.

40200 3/8" Magnetic Socket Holder, Red. Hang Card. Shipping wt. 2 lbs. 3 oz.

40210 3/8" Magnetic Socket Holder, Black. Hang Card. Shipping wt. 2 lbs. 3 oz.

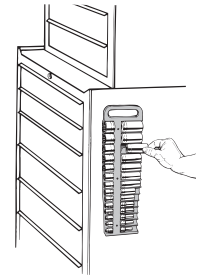
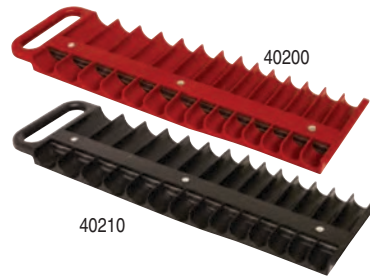

40120 40130 1/4" MAGNETIC SOCKET HOLDERS

Organizes 1/4" Fractional & Metric Sockets.

26 socket compartments allow you to keep your 1/4" standard and deep sockets in one convenient holder. Holds sockets up to 5/8" or 15mm. Design of holders leaves sockets exposed for easy identification. Powerful magnets securely hold sockets in tray, and tray to any steel surface. Made of strong ABS plastic.

40120 1/4" Magnetic Socket Holder, Red. Hang Card. Shipping wt. 1 lb. 3 oz.

40130 1/4" Magnetic Socket Holder, Black. Hang Card. Shipping wt. 1 lb. 3 oz.

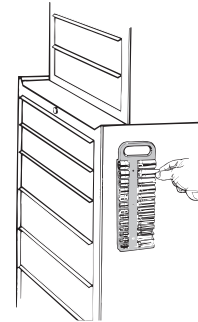
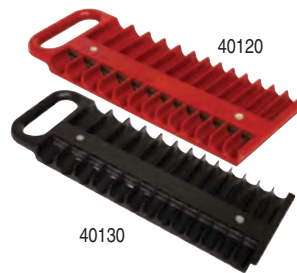

40900 40990 1/2" MAGNETIC SOCKET HOLDERS

Organizes 1/2" Chrome & Impact Sockets.

22 socket compartments allow you to keep your 1/2" standard and deep sockets in one convenient holder. Holds sockets up to 1" or 20mm. Design of holders leaves sockets exposed for easy identification. Powerful magnet holds sockets in tray. Rubber feet protect tool box from scratching. Made of strong ABS plastic. Will fit impact sockets.

40900 1/2" Magnetic Socket Holder, Red. Hang Card. Shipping wt. 2 lbs. 9 oz.

40990 1/2" Magnetic Socket Holder, Black. Hang Card. Shipping wt. 2 lbs. 9 oz.

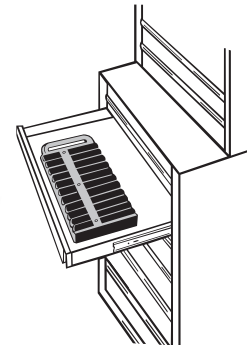

21300 21400 MAGNETIC TOOL HOLDERS

21300 - 13" Length. 21400 - 24" Length. Powerful Magnet Holds Even Heavy Hand Tools.

Ideal for both home and shop.

21300 13" Magnetic Tool Holder. Box. Shipping wt. 2 lbs. 4 oz.

21400 24" Magnetic Tool Holder. Box. Shipping wt. 4 lbs. 4 oz.

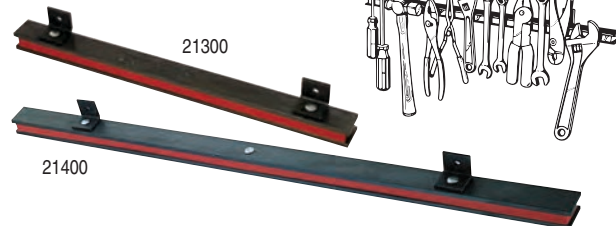

67300 MULTI-POSITION MAGNETIC NUT CUP

Strong Magnetic Base that Attaches Securely to Vehicles, Tool Boxes, Bins, Hoists and any Other Ferrous Metal Object.

The magnet has a coating to protect work surfaces and is oil and fuel resistant. Angled cup design allows positioning vertically, horizontally, or any angle in between. The 6" diameter cup is made of ABS plastic for durability. The strong magnet can hold up to 5 lbs. in a vertical position.

67300 Multi-Pos Mag Cup. Box. Shipping wt. 1 lb.



49700 49750 AIR HOSE HOLDERS

Strong Magnet Attaches to Ferrous Metal Surfaces to Keep Most 3/8" to 1/2" Shop Air Hoses off the Floor, Clean and Accessible.

Bright powder coat finish for visibility and durability. The tool can also be permanently mounted with screws.

49700 Air Hose Holder, Orange. Hang Tag. Shipping wt. 4 oz.

49750 Air Hose Holder, Green. Hang Tag. Shipping wt. 4 oz.



YouTube

21350 JEEPERS KEEPER™ CREEPER HANGER

Can be Attached to Most Toolboxes, Benches or Walls, Keeping a Creeper Off the Floor and Stored in One Location.

ABS plastic hooks mount anywhere on the 24" wide rail to accommodate different types of plastic or metal creepers. Two 5" slots line up with toolbox or cart handle mounting holes and allow mounting from 14" to 23".

21350 Creeper Hanger. Label. Shipping wt. 1 lb. 3 oz.

21380 Hanger Rail

21390 Hanger, 1 pc.



YouTube

49490 LOCKING TOOL HOLDER 24"

Holds up to 13 Tools, Including Pry Bars, Extensions and Air Tools.

Four 3/8" slots, one 7/16" slot, four 1/2" slots, two 5/8" slots and two 3/4" slots. Locking feature secures tools to the toolbox without taking valuable drawer space. Slotted mounting holes to fit most tool boxes and carts. Lock not included.

49490 Locking Tool Holder 24". Box. Shipping wt. 2 lbs. 10 oz.



YouTube

49960 LOCKING AIR TOOL HOLDER

Organize Air Tools with this Lockable Tool Holder.

Tool can hold up to five pneumatic tools in a 10" space. Comes with five slots that fit all popular quick connect fittings from Milton, Lincoln, Amflo and others. Can be mounted on a tool box, cart or wall for easy access. Locking feature protects your air tools from theft (lock not included). Durable powder-coated finish.

49960 Locking Air Tool Holder. Clam Shell. Shipping wt. 13 oz.



67870 STANDARD / HIGH ENERGY SPARK PLUG GAUGE & GAPPER

Gauges and Gaps all Types of Spark Plugs from .020" to .100" (.50mm to 2.53mm).

Tapered edge for gauging spark plugs. Specially designed hole with flange adjusts side wire of plug without pressuring center electrode.

67870 Standard/High Energy Spark Plug Gauge & Gapper. Skin-Packed. Shipping wt. 1 oz.

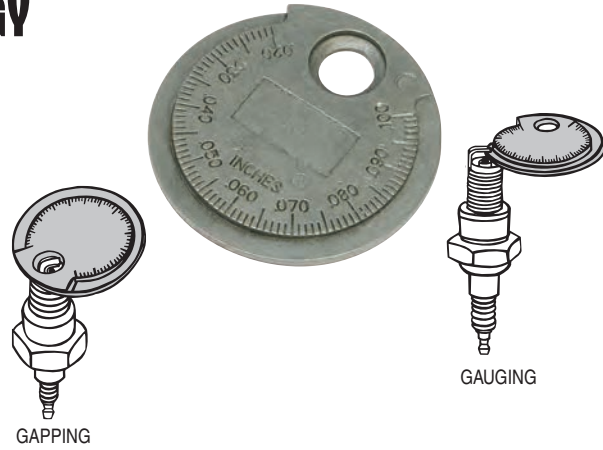

67800 67900 SPARK PLUG GAPPERS

For Standard and Electronic Ignitions.

67800 for standard ignition. 67900 for electronic ignition.

67800 Standard Spark Plug Gapper. Skin-Packed. Shipping wt. 2 oz.

67900 Electronic Ignition Spark Plug Gapper. Skin-Packed. Shipping wt. 2 oz.

67800		67900	
Inches	mm	Inches	mm
.025	.64	.040	1.02
.030	.76	.044	1.12
.034	.86	.045	1.14
.035	.89	.050	1.27
.040	1.02	.060	1.52
.045	1.14	.080	2.03

68100 DELUXE FEELER GAUGE

31 Blades. 1 Brass Blade .010".

Precision blades ensure accurate measurements. Blades from .0015" to .035" (.038 - .889mm) thickness are approximately 1/2" wide by 3-1/2" long.

68100 Deluxe Feeler Gauge. Skin-Packed. Shipping wt. 5 oz.

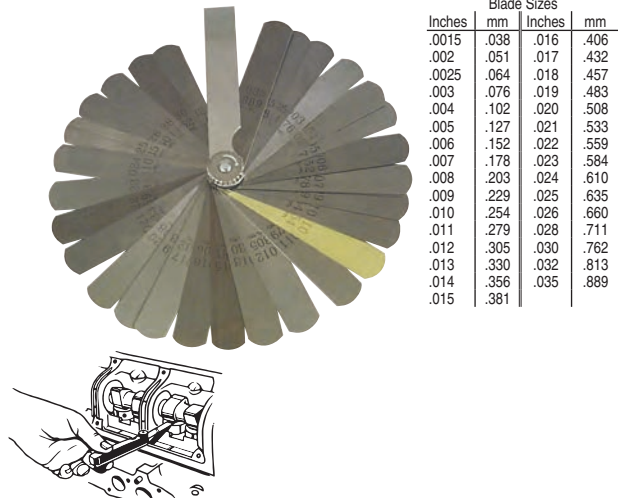

68000 MINI FEELER GAUGE

16 Steel Blades.

Precision blades ensure accurate measurements. Blades from .010" to .035" (.254 - .889mm) are approximately 1/4" wide by 1-3/4" long.

68000 Mini Feeler Gauge. Skin-Packed. Shipping wt. 1 oz.

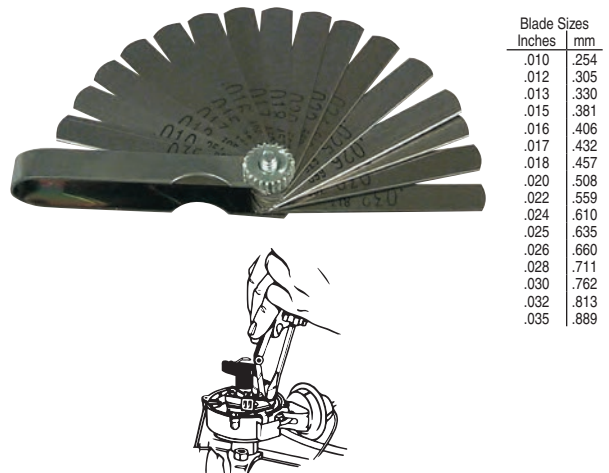

67950 STANDARD FEELER GAUGE

15 Steel Blades. One 2" Steel Rule.

Precision blades ensure accurate measurements. Blades are approximately 1/2" wide by 3-1/2" long.

67950 Standard Feeler Gauge. Skin-Packed. Shipping wt. 3 oz.

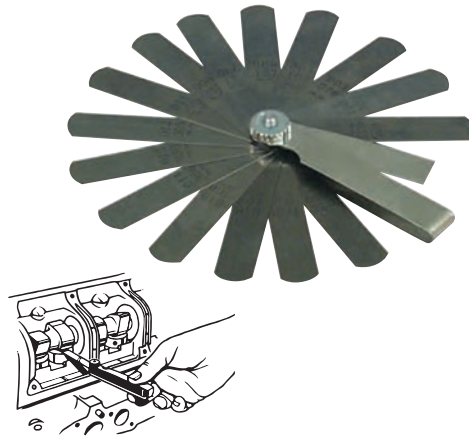

Blade Sizes	
Inches	mm
.002	.051
.003	.076
.004	.102
.005	.127
.006	.152
.008	.203
.011	.279
.012	.305
.013	.330
.014	.356
.016	.406
.018	.457
.020	.508
.022	.559
.025	.635

68050 VALVE TAPPET FEELER GAUGE

11 Offset Steel Blades.

Precision blades are offset at the proper angle for adjustment of valve tappets. Blades are approximately 1/2" wide by 4" long.

68050 Valve Tappet Feeler Gauge. Skin-Packed. Shipping wt. 3 oz.

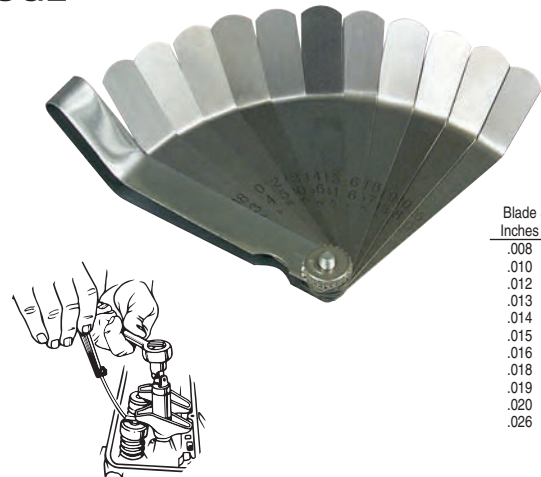

Blade Sizes	
Inches	mm
.008	.203
.010	.254
.012	.305
.013	.330
.014	.356
.015	.381
.016	.406
.018	.457
.019	.483
.020	.508
.026	.660

68150 GO-NO-GO FEELER GAUGE

22 Steel Blades.

Precision stepped blades have a .002" step for accurate settings. Blades from .004" to .027" (.102 - .686mm) are approximately 1/2" wide by 3-1/4" long.

68150 Go-No-Go Feeler Gauge. Skin-Packed. Shipping wt. 4 oz.

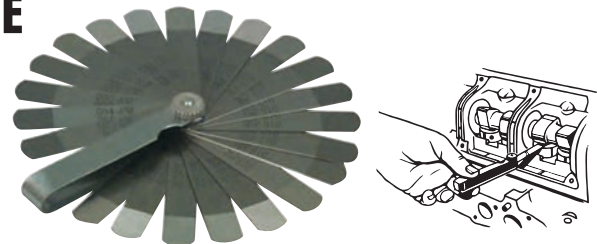

Blade Sizes							
Inches		mm		Inches		mm	
Low	High	Low	High	Low	High	Low	High
.004	.006	.102	.152	.015	.017	.381	.432
.005	.007	.127	.178	.016	.018	.406	.457
.006	.008	.152	.203	.017	.019	.432	.483
.007	.009	.178	.229	.018	.020	.457	.508
.008	.010	.203	.254	.019	.021	.483	.533
.009	.011	.229	.279	.020	.022	.508	.559
.010	.012	.254	.305	.021	.023	.533	.584
.011	.013	.279	.330	.022	.024	.559	.610
.012	.014	.305	.356	.023	.025	.584	.635
.013	.015	.330	.381	.024	.026	.610	.660
.014	.016	.356	.406	.025	.027	.635	.686

61090 61110 61130 DIESEL FILTER WRENCHES FOR DAVCO

Specially Designed Wrenches for Removing and Replacing the Main Filter Collar as well as the Vent Cap on Davco Aftermarket Diesel Fuel Filter Systems.

5", 6" and 8" wrenches with a unique half-moon design provide easier access to the fuel filter. High strength steel prevents the wrench from flexing while loosening stubborn filter collars. Four teeth grab the vent cap securely to prevent damage. Thick padded grip cushions your hand.

61090 5" Diesel Filter Wrench for Davco. Label. Shipping wt. 1 lb. 2 oz.

61110 6" Diesel Filter Wrench for Davco. Label. Shipping wt. 1 lb. 4 oz.

61130 8" Diesel Filter Wrench for Davco. Label. Shipping wt. 1 lb. 13 oz.

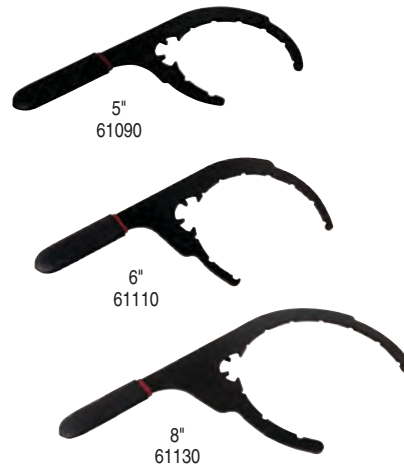

61060 DIESEL FILTER WRENCH FOR PACCAR

All Metal Wrench to Remove and Install Bowls on Newer Paccar Chassis Mounted Fuel Filter Assemblies.

Half-moon design allows easier access to the fuel filter found on Kenworth, Peterbilt and Cummins diesels. Laser-cut steel provides strength to loosen even the toughest bowls. Thick padded grip for comfort.

61060 Diesel Filter Wrench for Paccar. Label. Shipping wt. 13 oz.



61380 COMPACT WRENCH FOR PACCAR

Compact Wrench Provides 100% Engagement on the Fuel Filter Bowl.

Compact design and 3/8" square drive for easier access to Paccar chassis mounted fuel filter assemblies. Works on fuel filters found on Kenworth, Peterbilt and Cummins diesels. Heat-treated, high strength laser-cut steel for durability.

61380 Paccar Filter Wrench. Label. Shipping wt. 9 oz.



61140 DIESEL FILTER WRENCH FOR FORD TRANSIT

Wrench Is Used to Remove and Install Fuel Filter Elements on 3.2L Diesel Ford Transit Engines.

Works on 2015 to current 150, 250, and 350 models. The tool is notched to match the canister design to help eliminate slipping and damage to the canister. To remove the canister housing, slip the tool over the canister and turn the wrench to the unlock position on the canister. To install, apply upward pressure and turn the canister housing to the locked position. The tool also has a 3/8" square drive to provide extra leverage.

61140 Diesel Filter Wrench for Ford Transit. Label. Shipping wt. 12 oz.



61170 61180 61190 COMPACT WRENCHES FOR DAVCO

Compact 5", 6" and 8" Wrenches Provide 100% Engagement on the Fuel Filter Collar.

Compact design and 3/8" square drive for easier access to Davco chassis mounted fuel filter assemblies. 5" wrench works on any diesel engine with fuel flow rates up to 60 gph, Class 4, 5, & 6 trucks, pickup trucks, refrigeration units and some Biodiesel applications. 6" wrench works on any diesel engines found in Caterpillar CT660, CT11, CT13, CT15, Cummins, Detroit Diesel, International, Mercedes Benz, Paccar, Daimler Trucks North America, Kenworth, Mack, Navistar, Peterbilt, Thomas Built Buses and Volvo. 8" wrench works Detroit Diesel DD13, DD15 and DD16 engines found in Paccar, Daimler Trucks North America, and Volvo. Heat-treated, high strength laser-cut steel for durability.

61170 Davco Wrench 5". Label. Shipping wt. 6 oz.

61180 Davco Wrench 6". Label. Shipping wt. 7 oz.

61190 Davco Wrench 8". Label. Shipping wt. 12 oz.



YouTube



61170 5"

61180 6"

61190 8"

61070 VENT CAP WRENCH FOR DAVCO

Double Ended Wrench Removes Vent Cap on Top of Davco Chassis Mounted Fuel Filter System Canisters.

High strength steel wrench provides 100% engagement on the vent cap to prevent damage and make removal and installation easier. Newer Davco systems have a vent cap with large lobes and ratchets to prevent over tightening.

61070 Davco Vent Cap Wrench. Label. Shipping wt. 9 oz.



YouTube



49000 49020 49040 TRUCK CAGE BOLT SOCKET, 3/4", 15/16" & 1-1/16"

The Extra Deep 15/16" & 1-1/16" Works Well on the Spring Brakes and Removes Other Types of Clamps and Bolts.

49020 works on the 30/36 spring brakes for Autocar, CCC Style dump trucks, and garbage trucks with MGM brakes. 49040 Works on 30/36 spring brakes on 2016-2017 freightliner dump trucks and removes other types of clamps and bolts. The 49020 can also be used to remove fuel tank saddle clamps, headache rack U-bolts, and S-Cam brackets caging bolts. 49000 - Extra deep 3/4" of the socket loosens the cage bolt to unlock air brakes on trucks. Also removes the air brake booster for replacement. The sockets can be used with 1/2" drive and an impact wrench. The sockets are forged from alloy steel and heat treated. Also works on other 15/16" deep applications.

49000 Truck Spring Cage Bolt Socket. Skin-Packed. Shipping wt. 12 oz.

49040 Truck Cage Bolt Socket, 1-1/16". Skin-Packed. Shipping wt. 1 lb. 5 oz.

49020 Truck Cage Bolt Socket, 15/16". Skin-Packed. Shipping wt. 1 lb. 1 oz.

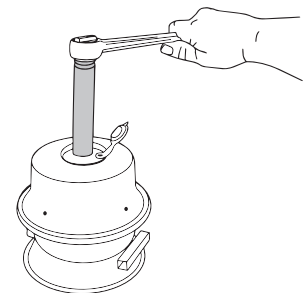
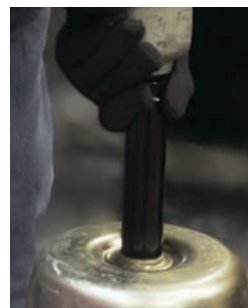

HEAVY DUTY

69910 69930 TURBO AIR SYSTEM TEST KITS W/SMOKE ADAPTER 14PC. & 10PC.

Includes T-Adapter for Connecting Smoke Machines to Help Locate Air Leaks in the Components.

Plugs the output side of the turbo and the intake inlet. Air and smoke are applied through one adapter to show the presence of leaks within the system. Features a pressure gauge, shut off valve and pressure regulator and includes six pairs of stepped adapters to fit most turbo systems on cars and light trucks. Can also be used on some cooling system hoses.

69910 Turbo Air System Test Kit w/Smoke Adapter, 14 pc.
Molded Case. Shipping wt. 8 lbs. 5 oz.

69930 Turbo Air System Test Kit w/Smoke Adapter, 10 pc.
Molded Case. Shipping wt. 9 lbs. 2 oz.

69710 31/38mm Plugged Adapter

69720 31/38mm Air Fitting Adapter

69730 46/51mm Plugged Adapter

69740 46/51mm Air Fitting Adapter

69750 55/60mm Plugged Adapter

69760 55/60mm Air Fitting Adapter

69770 65/70mm Plugged Adapter

69780 65/70mm Air Fitting Adapter

69790 75/80mm Plugged Adapter

69800 75/80mm Air Fitting Adapter

69810 85/90mm Plugged Adapter

69820 85/90mm Air Fitting Adapter

69850 95/100mm Plugged Adapter

69860 95/100mm Air Fitting Adapter

69870 105/110mm Plugged Adapter

69880 105/110mm Air Fitting Adapter

69840 Air Regulator Hose and Gauge

69920 Smoke Adapter

69830 Case for 69910

69890 Case for 69930

Supersedes 69700



69910 Adapters



69930 Adapters

Supersedes 69900



NEW
69920 Smoke Adapter

69840 Air Regulator Hose and Gauge

	Fits Hose I.D.	69910	69930
31/38 mm	1-1/4" / 1-1/2"	X	
46/51 mm	1-7/8" / 2"	X	
55/60 mm	2-1/8" / 2-3/8"	X	
65/70 mm	2-1/2" / 2-3/4"	X	
75/80 mm	3" / 3-1/8"	X	X
85/90 mm	3-3/8" / 3-1/2"	X	X
95/100 mm	3-3/4" / 4"		X
105/110 mm	4-1/8" / 4-1/4"		X

HEAVY DUTY

38450 STC® DISCONNECT KIT, 3 PC.

Quickly and Easily Release STCFittings.

The angled head provides extra clearance in tight spaces. Works on GM step vans with Allison transmission cooler lines and Ford 6.0L/7.3L high pressure oil lines. Also works on Case International and John Deere tractors: hydraulic lines, power steering lines, cooler lines and brake lines. Double-dip grip for comfort. Includes three sizes: 6, 8 and 10.

38450 STC Disconnect Kit, 3 pc. Skin-Packed. Shipping wt. 12 oz.

38460 STC Disconnect Tool #6

38470 STC Disconnect Tool #8

38480 STC Disconnect Tool #10

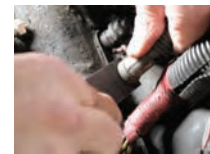

29090 TRUCK ANCHOR PIN BUSHING DRIVER, 2 PC.

Pneumatic Bushing Driver Set Removes and Installs Truck and Trailer 1-3/8" Anchor Pin Bushings and Stuck Anchor Pins.

Includes an 11-1/2" long driver that allows bushings to be driven straight without removing the hub assembly. Double-sided cone snaps onto driver to drive out and install bushings. Use flanged end to install and tapered end to remove. Also removes truck leaf spring bushings.

29090 Truck Anchor Pin Bushing Driver, 2 pc. Skin-Packed. Shipping wt. 1 lb. 7 oz.

29070 Remover/Installer Cone

29080 Pneumatic Driver Assembly



29450 SHORT PNEUMATIC ANCHOR PIN BUSHING DRIVER

Includes a 7" Driver for Applications with Limited Access.

Pneumatic bushing driver set removes and installs truck and trailer 1-3/8" anchor pin bushings and stuck anchor pins. Double sided cone snaps onto driver to drive out and install bushings. Use flanged end to install and tapered end to remove. Also removes truck leaf spring bushings.

29450 Anchor Pin Driver. Skin-Packed. Shipping wt. 1 lb. 4 oz.

29070 Remover/Installer Cone

29470 Short Pneumatic Driver Assembly



Supersedes 28890



U.S. Pat. No. 11,117,246

61900 HEAVY DUTY BEARING RACE & SEAL DRIVER SET

Fits Most Class 8 Over the Road Trucks and Trailers and Some Medium Duty Trucks.

Use the tapered driver side for bearing races and the flat side for seals. Includes six drivers and handle extension for driving bearing races and seals on hubs with deep brake drums without removing the drums. For applications that do not need the length of the two-piece handle, use only the handle with the solid end. Use the included hardened washer between the driver and handle to protect the aluminum driver.

61900 Heavy Duty Bearing Race & Seal Driver Set. Molded Case. Shipping wt. 9 lbs. 8 oz.



Drivers Included:

- 61910 4-7/8"
- 61920 4-13/16"
- 61930 5-1/2"
- 61940 5-25/32"
- 61950 6"
- 61960 3-43/64"

61850 TRUCK HUB SEAL INSTALLER KIT

Fits the Most Popular Size Seals for Class 7 and Class 8 Over the Road Trucks and Trailers and Some Medium Duty Trucks.

The driver is designed to hold the seals to make installation easier. Includes five drivers and handle extension for extra reach for driving seals on hubs with deep brake drums without removing the drums.

61850 Truck Hub Seal Installer Kit. Molded Case. Shipping wt. 9 lbs. 13 oz.

Drivers Included:	Fit Seal #
61700 4-13/16"	370001A
61730 5-11/16"	370023A
61720 5-31/32"	370025A
61740 6"	370065A
61710 6-5/16"	370003A



38700 SPINDLE SNAP RING PLIERS FOR FORD SUPER DUTY

Used to Replace the Spindle Snap Rings Found on 2007 and Newer Ford Super Duty Pickups.

Rigid plier design with narrow tips to fit into the 2-1/2" inside diameter of the hub. Ratcheting lock mechanism holds the snap ring open for easy removal and installation.

38700 Spindle Pliers Ford. Skin-Packed. Shipping wt. 15 oz.

38710 Straight Tip Set

59330 Screw

67940 Washer



Patent Pending

61840 ENGINE BARRING TOOL FOR PACCAR

Allows the Engine Crank to Be Manually Adjusted.

Works on Paccar MX-13 engines, found on Kenworth and Peterbilt trucks. Can be used to make sure the engine rotates freely while troubleshooting other issues. Use with 1/2" square drive.

61840 Engine Barring Tool for Paccar. Box. Shipping wt. 10 oz.



22130 36MM 12 PT. BARRING WRENCH FOR DURAMAX

Works on 2001 and Newer Duramax Engines to Turn the Crankshaft Allowing Access to the Torque Converter Bolts.

The 22-1/2" long, offset design allows the 36mm 12 point wrench to clear the stabilizer bar from under the truck. The wrench can also be used to make sure the engine rotates freely while troubleshooting other issues. Dual material grip for comfort.

22130 36mm Barring Wrench. Label. Shipping wt. 1 lb. 14 oz.



YouTube

59600 DEUTSCH TERMINAL TOOL

Works on OEM Electrical Connectors Used on Trucks and Equipment Such as Caterpillar, Kenworth, Peterbilt, Freightliner, Mack & More.

Also used on some Harley Davidson and industrial equipment connectors. Slotted tubes are made from stainless steel which is more durable than plastic. Built in a convenient "spider" design so the most popular sizes are always available. To use, slide appropriate size slotted tube over wire. Push the tool into the grommet, bottoming out the tool on the terminal. DO NOT TWIST THE TOOL. Pull the wire-terminal out of the connector.

59600 Deutsch Terminal Tool. Skin-Packed. Shipping wt. 2 oz.



Three Tip Sizes to Fit:

14-16 AWG and size 14 contacts

16-18 AWG and size 18 contacts

20-24 AWG and size 20 contacts

21520 TRUCK PEDAL DEPRESSOR

Depresses & Holds Clutch Pedals & Brake Pedals.

The two-piece, telescoping tool extends to pedal & locks in position. Brace the formed plate against the seat or steering wheel for support. Tool extends from 18-1/2" to 34-1/2".

21520 Truck Pedal Depressor. Skin-Packed. Shipping wt. 2 lbs. 4 oz.

45980 Replacement Rubber Tip

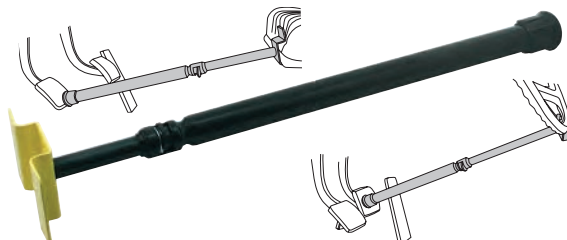

47120 ROTARY WATERFALL DISPLAY

Feature Even More Tools in a Compact Space.

The compact, four-sided display takes up less than one square yard of floor space while holding 176 tools. Comes complete with hooks, plan-o-gram label strips, color-coded tool finder, and easy set-up instructions. The display is mounted on rollers for easy movement. A real money maker... increases impulse sales.

47120 Rotary Waterfall Display. Box. Shipping wt. 227 lbs.



47500 4' GONDOLA DISPLAY

Use Your Existing Gondola Space to Merchandise 73 of Our Most Popular Specialty Tools.

Display bars fit most standard 4' high gondolas with a 4' wide section. Bars easily adjust to fit taller display areas. Comes complete with 7 1" x 4' bars, hooks, plan-o-gram label strips, tool finder, easy set-up instructions, and header sign. Gondola not included.

47500 Waterfall Gondola w/Tools, 4'. Box. Shipping wt 76 lbs.

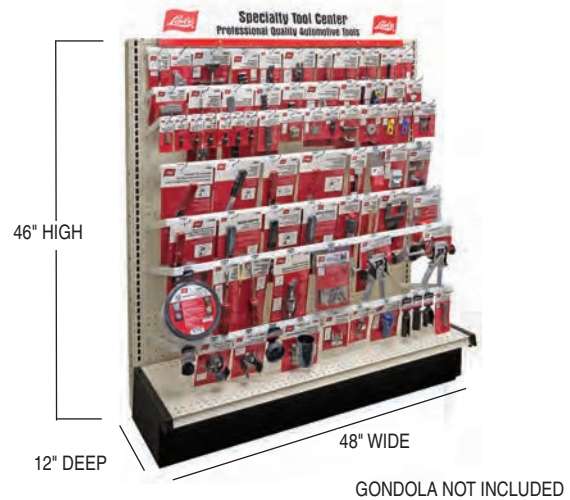

47600 8' GONDOLA DISPLAY

Use Your Existing Gondola Space to Merchandise Our Most Popular Specialty Tools.

Feature 140 tools in only 96" x 46". Display bars are compatible with most standard 4' high gondolas with 4' wide sections. If your display area is taller, simply adjust the bars upward. Comes complete with 14 1" x 4' bars with hooks, plan-o-gram label strips, tool finder, easy set-up instructions, and header sign. Gondola not included.

47600 Waterfall Gondola w/Tools, 4'. Box. Shipping wt. 155 lbs.



DISPLAY

48210 2' SPECIALTY TOOLS DISPLAY

Use Your Existing Gondola Space To Merchandise 38 Popular Specialty Tools.

Display bars fit most standard 4' high gondolas with a 2' wide section. Bars easily adjust to fit taller display areas. Comes complete with 7 1" x 2' bars, hooks, plan-o-gram label strips, easy set-up instructions, and header sign.

48210 2' Specialty Tools Display. Box. Shipping wt. 37 lbs.

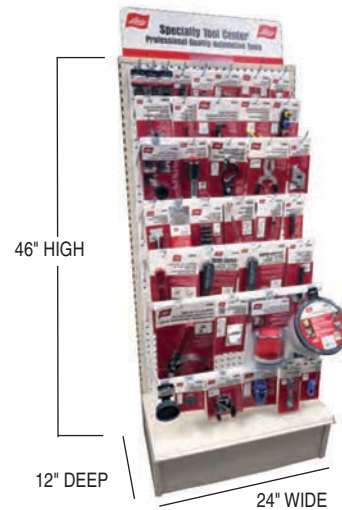

GONDOLA NOT INCLUDED

48810 2' FARM & AG DISPLAY

Use Your Existing Gondola Space To Merchandise 31 Farm And Ag Tools.

Display bars fit most standard 4' high gondolas with a 2' wide section. Bars easily adjust to fit taller display areas. Comes complete with 7 1" x 2' bars, hooks, plan-o-gram label strips, easy set-up instructions, and header sign.

48810 2' Farm & Ag Display. Box. Shipping wt. 45 lbs.



GONDOLA NOT INCLUDED

49090 2' FILTER WRENCH DISPLAY

Use Your Existing Gondola Space To Merchandise 31 Filter Wrenches.

Display bars fit most standard 4' high gondolas with a 2' wide section. Bars easily adjust to fit taller display areas. Comes complete with 7 1" x 2' bars, hooks, plan-o-gram label strips, easy set-up instructions, and header sign.

49090 2' Filter Wrench Display. Box. Shipping wt. 42 lbs.



GONDOLA NOT INCLUDED

PEGBOARD BARS

Create a Custom Display.

Display bars fit into pegboard gondola displays or pegboard wall for universal application. Bars are 45" long to fill the pegboard area of a 4' gondola. Available in 1", 3", 6", 9" and 12" Sizes. Bars can be waterfalled to save pegboard space.

48890 1" Bar. Shipping wt. 2 lbs. 8 oz.	48900 3" Bar. Shipping wt. 3 lbs.
48910 6" Bar. Shipping wt. 3 lbs. 4 oz.	48920 9" Bar. Shipping wt. 3 lbs. 8 oz.
48930 12" Bar. Shipping wt. 3 lbs. 14 oz.	
47540 Bag of 30 Bar Hooks. Shipping wt. 1 lb. 8 oz.	



DISPLAY

48160 STOCKING TAGS

Handy Tags to Create Your Own Plan-a-Gram.

Universal tags help keep track of your specialty tool inventory and prompt you to reorder out of stock items. Tags can be used to add new tools that are not yet available on our displays. Available in convenient pads of 100 tags with pre-drilled holes to fit pegboard hooks. Stocking tags are free.

48160 Stocking Tags. 100 per pad.



70450 FLEXIBLE LIGHT HOLDER WITH SPRING CLAMP

Flexible Light Holder Works Like a Third Hand. Strong Industrial Spring Clamp Allows a Light to be Conveniently Located.

A flexible 9" gooseneck design provides bends over 90° and rotates 360° to aim light where it is needed. Holds a variety of flashlights or trouble lights (from .625" To 2" diameter) with the two position, flexible finger design.

70450 Flexible Light Holder with Spring Clamp. Hang Card. Shipping wt. 9 oz.

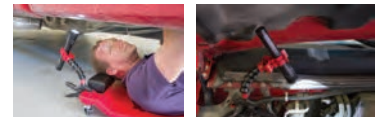

YouTube

71070 FLEXIBLE LIGHT HOLDER WITH MAGNETIC BASE

Flexible Light Holder Works Like a Third Hand. Powerful 2" Diameter, 50 lb. Pull Magnet Allows a Light to be Conveniently Located.

A flexible 9" gooseneck design provides bends over 90° and rotates 360° to aim light where it is needed. Holds a variety of flashlights or trouble lights (from .625" To 2" diameter) with the two position, flexible finger design.

71070 Flexible Light Holder with Magnetic Base. Hang Card. Shipping wt. 7 oz.



YouTube

LIGHTING

35900 LED FLEXIBLE FLASHLIGHT

LED Bulb Lasts For Up to 100,000 Hours.

Flexible wire works around obstructions and holds the shape you give it. White light brightly illuminates even the tightest work areas. Uses 3 AAA batteries not included.

35900 LED Flexible Flashlight. Skin-Packed. Shipping wt. 2 oz.

35910 Replacement Bulb Assembly

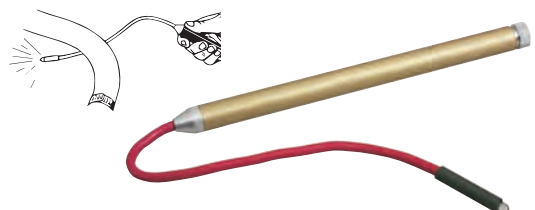

**92102 93102 93202 93602
94102 97102 99102 LOW
PROFILE PLASTIC CREEPERS**

The Best Plastic Creeper on the Market.

This body-fitting design was developed through testing on many body types to provide optimum comfort. Creeper body is 2" longer for a better fit. Urethane rollers are inserted into steel bushings which are molded into the creeper body. Provides added strength and easy roller replacement. Low profile, 7/8" floor clearance. Easy to clean surface is resistant to solvents, greases and fuels. Dimensions: Length 38", Width 17-1/2", Height 4".

92102 Red Plastic Creeper. Box. Shipping wt. 11 lbs. 8 oz.

93102 Yellow Plastic Creeper. Box. Shipping wt. 11 lbs. 8 oz.

93202 Orange Plastic Creeper. Box. Shipping wt. 11 lbs. 8 oz.

94102 Blue Plastic Creeper. Box. Shipping wt. 11 lbs. 8 oz.

97102 Black Plastic Creeper. Box. Shipping wt. 11 lbs. 8 oz.

99102 Green Plastic Creeper. Box. Shipping wt. 11 lbs. 8 oz.

92132 2" Pop-in Wheel for Plastic Creeper

96412 Headrest



92102



93102



93202



94102



97102



99102

CREEPERS

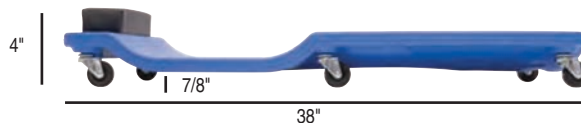

92032 93032 94032 LARGE WHEEL CREEPERS

Bigger Wheels for a Better Ride.

Our popular plastic creepers are now available with larger, 4" pop-in urethane wheels. The larger wheels provide a much smoother ride on cracked or uneven floor surfaces, over floor debris and under heavy loads. Also rolls better on regular floor surfaces. The creeper body is the same as our low profile plastic creeper models 92102, 93102 and 94102.

92032 Large Wheel Plastic Creeper, Red. Box. Shipping wt. 14 lbs. 8 oz.

93032 Large Wheel Plastic Creeper, Yellow. Box. Shipping wt. 14 lbs. 8 oz.

94032 Large Wheel Plastic Creeper, Blue. Box. Shipping wt. 14 lbs. 8 oz.

96572 4" Pop-in Wheel

96412 Headrest



Dimensions: length 38", width 17-1/2", height 8-5/8", floor clearance 3-3/4".

NOTE: You can interchange or retrofit your conventional Lisle plastic creeper with six 96572 4" rollers.

95002 FOLD UP CREEPER

The Padded Vinyl Creeper Adds Comfort and Protection on the Job.

Works great on off road situations and under a vehicle where no jacks or lifts are used. Folds up and hangs for convenient storage.

95002 Fold Up Creeper. Box. Shipping wt. 2 lbs. 15 oz.



Dimensions:
Unfolded 18" x 48",
Folded 18" x 24".

REPLACEMENT ROLLERS AND WHEELS

The 99702 3" steel rollers or 99802 2-3/4" engineering plastic rollers are utilized on our wooden creepers. As an option you can replace these rollers with our 97112 2" wheel with bracket. Both provide a lower profile effect. The 96132 2" oil resistant plastic wheel is standard on all Lisle steel creepers. This low-profile wheel comes with a cap nut and lock washer to prevent loosening. The 92132 2" Pop-in Wheel is standard on our new style plastic creepers. The 96572 Larger 4" wheel for plastic creepers works especially well on cracked or uneven floor surfaces. The 96422 2" oil resistant plastic wheel was standard on all plastic creepers before late 1998. The 96422 wheel includes a cap nut 96552.

92132 2" Pop-in Wheel for Plastic Creepers. Shipping wt. 6 oz.

96132 Wheel for Steel Creepers. Shipping wt. 6 oz.

96142 Cap Nut for 96132. Shipping wt. 1 oz.

96422 Wheel for Plastic Creepers. Shipping wt. 6 oz.

96552 Cap Nut for 96422. Shipping wt. 1 oz.

96572 Large Creeper Wheels. Shipping wt. 1 lb.

92132 POP-IN WHEEL FOR PLASTIC CREEPERS
Specifications:
Wheel, 2" dia.
Overall Height, 2-3/4"



For all plastic models.

96132 REPLACEMENT WHEELS FOR LOW PROFILE STEEL CREEPERS
Includes cap nut.
Specifications:
Wheel, 2" dia.
Overall Height, 2-1/2"



96422 REPLACEMENT WHEELS FOR LOW PROFILE PLASTIC CREEPERS
Includes cap nut.
Specifications:
Wheel, 2" dia.
Overall Height, 2-1/2"



For older style plastic creepers, 96402, 96502, 96602, 96702 & 96802.

96572 LARGE POP-IN WHEEL FOR PLASTIC CREEPERS
Specifications:
Wheel, 4" dia.
Overall Height, 4-3/4"



For models 92032 93032 94032 or retrofit models 92102, 93102 & 94102.



Lisle Corporation Marks Over 118 Years of Manufacturing

Lisle Corporation recently celebrated the company's founding, and over 118 years of continuous manufacturing, in Clarinda, Iowa. The privately owned company is led today by third, fourth, fifth and sixth generation family members.

C.A. Lisle started the company in 1903 with the first product being horse-powered water well drilling machines. To combat the seasonality of the well drilling business, the young company branched out and also manufactured washing machines, cream separators, and push-type reel lawn mowers.

In the mid-20s, Lisle Corporation made its first automotive product, a master ignition vibrator for Ford Model T vehicles. The first Lisle tool, a valve refacer, fast became a repair shop must since valves were reground every 20,000 miles at that time.

In the 1930s the magnetic drain plug line was launched. The line grew steadily and Lisle plugs were used extensively in many pieces of military equipment during World War II. The company was subsequently awarded the Army/Navy E Award for manufacturing excellence in supporting the war effort.

In the post-war 50s, the automotive aftermarket boomed and demand for specialty automotive tools increased. Lisle Corporation made the decision then

to grow the company by introducing new tools that could be made in the company's own factory, thereby controlling quality, delivery and costs.

Then a line of mechanic's garage creepers was added through acquisition. The line still is sold today under the Jeepers Creepers brand name.

At this time private label business began to grow. This portion of the business thrives on today. Tools manufactured by Lisle Corporation can be found private labeled under many of the leading tool and automotive part brand names available in the marketplace.

The company has branched out even more in the last decades through acquisitions and constant innovation of new products. Today, Lisle specialty automotive tools, mechanic's creepers, and lubrication & tire products are the preferred line among automotive warehouse distributors and jobbers because Lisle manufactures quality products that are priced right. The specialty automotive tool line now consists of more than 750 products, with the great majority of them being produced at the expanded site of the original factory built in Clarinda, Iowa in 1903.

For product assistance, call us at 712-542-5101 or e-mail us at info@lislecorp.com.

TURN YOUR TOOL IDEA INTO MONEY

Lisle Corporation Currently Pays Royalties To Over 100 Individuals.

If you have an original tool idea which others may need, Lisle Corporation is interested in evaluating your idea. Your idea may be produced and sold by Lisle Corporation under an attractive Award or Royalty Agreement that will bring you an income for years to come. If you have a new tool idea, or have identified a problem, follow these two simple steps:

1. Write Lisle and request an Idea Disclosure Agreement or fill out a request form on our website: www.lislecorp.com/idea-program
2. Return the signed agreement to Lisle Corporation. We will promptly evaluate your idea. You will then be notified whether or not we will offer an award or royalty.

I.D.A. Program
Lisle Corporation
807 E. Main Street
PO Box 89
Clarinda, Iowa USA 51632-0089
www.lislecorp.com/idea-program



A PROVEN SUCCESS FORMULA!



Lisle Corporation has been in business since 1903 with sales distribution throughout the world. Through the years, we have been a leader in developing and marketing new tools for the automotive service industry. Most of these new tools were developed by our own engineering department...but many successful tools were the ideas of individual mechanics who recognized a problem. Lisle Corporation has been working with submitters of new tool ideas on an award or royalty basis for more than 50 years.

INDIVIDUALS JUST LIKE YOU HAVE DEVELOPED THE FOLLOWING LISLE TOOLS:

55000 MAGNETIC SOLDERING CLAMP

Offers an extra pair of hands when soldering. Alligator clamps firmly hold wire and small parts when soldering. Flexible design allows different ways to attach and hold wire.



56810 RELAY TEST JUMPER KIT

Set of four relay test jumpers make testing relays or live circuits quick and easy. Fits many popular size relays on domestic and import vehicles. Simply remove relay to be tested, insert correct jumper and insert relay into jumper.



57020 SMALL SWIVEL-GRIPPER™

"No-Slip" filter wrench. Tough, Stainless steel band with permanently bonded textured coating for superior gripping power...Won't slip.



65600 BROKEN SPARK PLUG REMOVER FOR FORD TRITON 3 VALVE ENGINES

This tool set removes broken spark plugs from 2004 and newer Triton 3 valve per cylinder engines, (a common problem). The set includes a unique porcelain pusher tool and a tapered left-hand thread remover for removing the broken spark plug without leaving the porcelain in the engine cylinder.



Jason Jantzer
Phoenix, Oregon

Mr. Jantzer's tool ideas (our **43300** Pneumatic Fan Clutch Wrench Set, **36880** Dual Overhead Cam Lock Tool and **18980** Pneumatic U-Joint Driver) are submissions that have been added to the Lisle tool line.







www.lislecorp.com

Catalog T-101 ©2022 Lisle Corporation
 Printed in USA 1/22-50M Part#10.94

Visit Our Website For More Information And Resources:

-  Idea Program: lislecorp.com/idea-program/
-  Resource Center Downloads: lislecorp.com/downloads/
-  Videos: lislecorp.com/videos/

Follow Us On Social Media

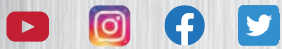

WARNING: Cancer and Reproductive Harm - www.P65Warnings.ca.gov.



Distributed by