

Statement

- This manual is designed for the use of CanDo C-Pro diagnostic tool and cannot be copied or stored in any form (electronic, mechanical, photocopying, recording or otherwise) without prior written permission being secured by CanDo International, Inc.
- This manual is intended for professional vehicle repair technicians and provides the operation methods for using CanDo products. CanDo International, Inc. accepts no responsibility for the consequences caused by abusing the operation methods on other equipment.
- CanDo International, Inc. shall not undertake any responsibility for accidents caused by the user personally or other people, costs and expenses due to equipment damages and equipment loss that are caused by the user's abuses, misuses, arbitrary changes, repairs, or operations of the equipment not in accordance with the manual requirements. This manual is written in accordance with the existing configuration and functions of the product, it's subject to change without notice if the product adds new configuration and functions.
- CanDo International, Inc. has registered the CanDo trademark in America. The company declares that the ownership of the registered trademark, service mark, domain name, logo, and company name in countries which they have not yet been registered belongs to CanDo International, Inc.. The other products and their company name trademarks mentioned in this manual belong to the original registered company. The trademarks, service marks, domain names, logos, and company names of CanDo International, Inc. or other companies mentioned may not be used without prior written permission of the owner.

Registered Trademark

CanDo International, Inc. has registered the trademark in America and several countries overseas. The company declares that the ownership of the

registered trademark, service mark, domain name, logo, and company name in countries which they have not yet been registered belongs to CanDo International, Inc.. The other products and their company name trademarks mentioned in this manual belong to the original registered company. The trademarks, service marks, domain names, logos, and company names of CanDo International, Inc. or other companies mentioned may not be used without prior written permission of the owner.

CanDo Product Manual Instructions

Please read this manual carefully before using the CanDo product.

- This manual is written in accordance with the existing configuration and functions of product and it's subject to change without notice if the product adds new configuration and functions. The new version of the manual can be downloaded from CanDo official website, please pay attention to "Note", "Remark" and "Instruction" in the manual to make sure the safe and correct use.

CanDo International, Inc.

Tel: 1-909-CanDo-11(226-3611)

Office: 138 E. Lemon Ave., Monrovia, CA 91016 USA

Website: www.CanDointl.com

Contents

Chapter I Product Introduction.....	5
1.1 Product Overview.....	5
1.2 Product Features.....	5
1.3 Service and Maintenance.....	6
1.3.1 Storage Environment.....	6
1.3.2 Host Protection.....	7
1.3.3 Screen Maintenance.....	7
1.3.4 Precautions.....	7
1.4 Automobile Inspection Notes.....	8
1.5 Product Help.....	9
Chapter II Product Structure.....	10
2.1 Host Hardware Instruction.....	10
2.1.1 Host Diagram.....	10
Chapter III VCI BOX Structure.....	12
VCI Box Parameters.....	13
Chapter IV Operation Manual.....	13
4.1.1 Host Power Supply.....	14
① Connect the power adapter (power adapter).....	14
② Dock the CanDo main unit on docking station.....	14
4.1.2 Wiring Method.....	14
4.1.3 Startup and Shutdown.....	15
4.2.1 Main Interface.....	15
4.2.2 Vehicle Diagnosis.....	16
4.2.3 VCI Connection.....	17
4.2.4 Data Management.....	18
4.2.5 Remote Diagnosis.....	19
4.2.6 Update.....	19
4.2.7 Help.....	20
4.2.8 Setting.....	20
Chapter V Update.....	24

Chapter VI Compliance Information	25
FCC COMPLIANCE FCC ID: 2AKNY-IDSCPRO.....	25
Table: OBD-II Terminal Function.....	29
Chapter VII Warranty	31

Chapter I Product Introduction

1.1 Product Overview

CanDo C-Pro diagnostic tool is developed and promoted with emphasis by CanDo International, Inc. Co., Ltd. Its comprehensive auto diagnosis equipment on diesel electric control system detection is applicable to large, medium and small repair enterprises, training institutions, automakers, maintenance station and many more.

The product software configuration is all-round with complete vehicle model data and materials. It fully meets the strict requirements in diagnosis of customers. The software covers almost vehicle model data, and provides strong repair material and help system that allows users to deal with problems in practical work easily and quickly so as to improve work efficiency and technical level.

The appearance design is luxury and comfortable with the large TFT touch screen for operations. Mode setup function for multiple working conditions satisfies the working demands in different circumstances. Adopting flexible drive technology, CanDo C-Pro diagnostic tool with good scalability fully meets requirements of various communication bus tests for current automobile electronic control systems.

1.2 Product Features

The core hardware of CanDo C-Pro adopts the international advanced modular design concept. Other than running in high speed and stabilization, accurate data acquisition and other excellent performances, it also has the ability to resist high and low temperature difference.

CanDo C-Pro diagnostic tool adopts the open structure design in the program framework. Its independent operation system allows the system software and diagnostic software to upgrade more conveniently.

Working power supply is from the automotive batteries, which is widely adapted to the voltage changes between 9~27V. The internal power supply uses the design of isolated power supply with the efficient protection of machine from damages when automobile voltage is abnormal.

CanDo C-Pro diagnostic tool has good scalability and the communication interface adopts the flexible drive circuit. It not only meets requirements of tests for current automotive bus, but also satisfies bus automotive tests that may appear in the future. It has built-in high/low speed CAN-BUS and satisfies electronic systems which adopt bus with Can-Bus protocol, and it only needs one diagnostic connector to perform the fault diagnosis on all automobiles that are equipped with CAN-BUS. It also fully supports all OBD-II protocols.

With a USB port to connect the printer, CanDo C-Pro diagnostic tool host is convenient for the maintenance staff to record data and save fault codes and other important information during the automobile fault diagnosis.

The CanDo C-Pro diagnostic tool host screen is the general international standard LCD TFT industrial touch screen. It has features such as the characters are clear in the strong sunshine, the touch-keys are accurate, the interface is broad and the screen's compressive strength is high and many other advantages. Its working stability is also advantageously guaranteed while using it in bad environments.

The CanDo C-Pro diagnostic tool provides various versions and languages in order to adapt to the use in different countries and districts.

1.3 Service and Maintenance

1.3.1 Storage Environment

- 1) Please store in a flat, dry place with suitable temperature when it's not in use.
- 2) Please do not put in direct sunlight or places near heating devices.
- 3) Please do not place in the range of the magnetic field.
- 4) Please do not put it in places with smoke, water or oil.

- 5) Please do not put it in places where is dusty, humid and high temperature or easily to be shaken.
- 6) When the host is dirty, please turn off the power supply immediately, and then wipe the housing case with a soft wet cloth.
- 7) Please regularly run the diagnostic tool host to protect it from damp when it is not in use for extended periods.

1.3.2 Host Protection

- 1) Please handle the host with care as possible as you can to avoid impacts.
- 2) When connecting the test cable and the automobile for diagnosis, please plug carefully. And tighten the fastening screw when it's in use in order to protect the interface from being damaged in the process of movement, please first loosen the screw after use and then unplug the main testing cable to avoid that the diagnosis interface gets damaged.
- 3) After using the instrument, put the test cable, connectors and other accessories back to the assembly case to avoid missing.

1.3.3 Screen Maintenance

- 1) The screen surface will absorb dust due to the static electricity. It's recommended to purchase the LCD special cleaning cloth to clean the host screen and wipe it gently.
- 2) Do not wipe the dust with your fingers to avoid leaving fingerprints. Do not use chemical cleaners to wipe the screen.
- 3) Please do not place the product near electric equipment that generates electromagnetic wave interferences so as not to affect the display.
- 4) Please do not expose the screen in direct sunshine or ultraviolet lighting for long time so as not to affect the life of the screen.

1.3.4 Precautions

- 1) It's prohibited to frequently turn on/off the host, suddenly turn off the
-

power supply, and to provide unstable power supply or artificial abnormal power supply.

- 2) If it's not in use, please unplug the power supply connector to protect the electrical components from aging when electrifying for long time.
- 3) Avoid using this product in an environment with air which has volatile alkali chemical, so as to avoid host hardware corrosion.
- 4) Never clean the product with chemical solvent reagents like banana water, engine cleaning agents, gasoline etc.
- 5) Do not put anything on the screen. To avoid any damage, please don't place objects on the screen.
- 6) Periodically start the CanDo main unit if not operated for a long time in order to avoid moisture accumulation.

1.4 Automobile Inspection Notes

Please perform operations according to automobile repair industry safety rules. Special attention should be paid to influences and damages caused by acid and alkali, poison gas, high pressure and other environmental factors.

There is sulfuric acid in the automobile battery. The sulfuric acid is corrosive to the skin so please avoid direct contacts with the battery when operating the product, especially do not splash it into eyes, and please keep kindling materials far away.

There are various kinds of toxic compounds in the engine exhaust gas, please do not breathe in the exhaust gas, please park the vehicle in well-ventilated places during operations.

The temperature is relatively high when the engine drives, please do not touch the water tank or exhaust pipe or other high-temperature components.

Please apply the handbrake before starting the engine, put the shift lever in the neutral gear (manual transmission) or P gear position (automatic transmission) to avoid traffic accidents when starting the engine.

Please apply the parking brake before performing the vehicle maintenance. The transmission is engaged into the neutral gear or P gear and to lower the

driver's side window glass.

If the engine can be started, please first warm up the vehicle to the normal temperature (the water temperature is about 80 °C), and turn off auxiliary electronic equipments (e.g. A/C, light and audio).

Please find the diagnostic socket on the vehicle, check and confirm that the diagnostic socket cable is in good condition, and then connect the host to diagnose. Otherwise please do not perform the test in order to protect the host from damages, or you can use the multimeter to measure the diagnostic socket voltage if it is necessary.

1.5 Product Help

The CanDo C-Pro diagnostic tool maintenance is simple and convenient, and support services go with the host. Our marketing networks all around the country could provide the most convenient and fastest services in all aspects of purchase, use, upgrade and maintenance.

CanDo International, Inc. also provides online help function for users. If you want to learn our latest products or automobile diagnostic information, please visit www.CanDointl.com for comprehensive and detailed help services.

Chapter II Product Structure

2.1 Host Hardware Instruction

2.1.1 Host Diagram

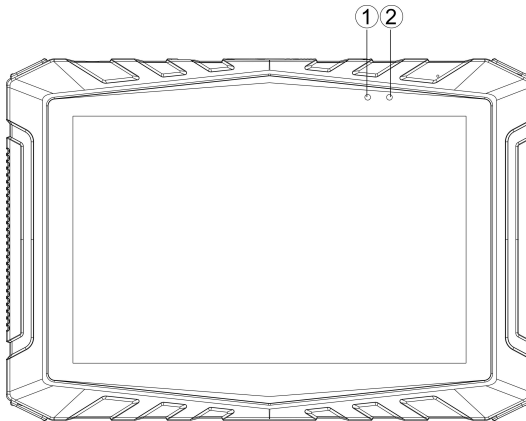

No.	Name	Description
①	Optical sensor	External light intensity induction
②	Power light	Charging light

Host parameter

System	Android 5.1 multi- task operating system
Processor	Cortex-A17 RK3288 Quad-core processor, 1.8GHz Architecture processor
Touch screen	IPS 8” Resolution: 800*1280
Touch screen	8 inch 5 point capacitive screen, G+G, hardness above 7H, anti-scratch, TP thickness: 1.1mm, COF
RAM	2GB RAM & 32GB ROM , support 32GB TF memory card
Connection	WiFi &Bluetooth 2.0/4.0

Camera	Rear 5 million pixels, Support auto focus
Interface	HDMI HD interface、USB2.0、TF Card slot, Power interface
Size	232mm*159mm*27mm

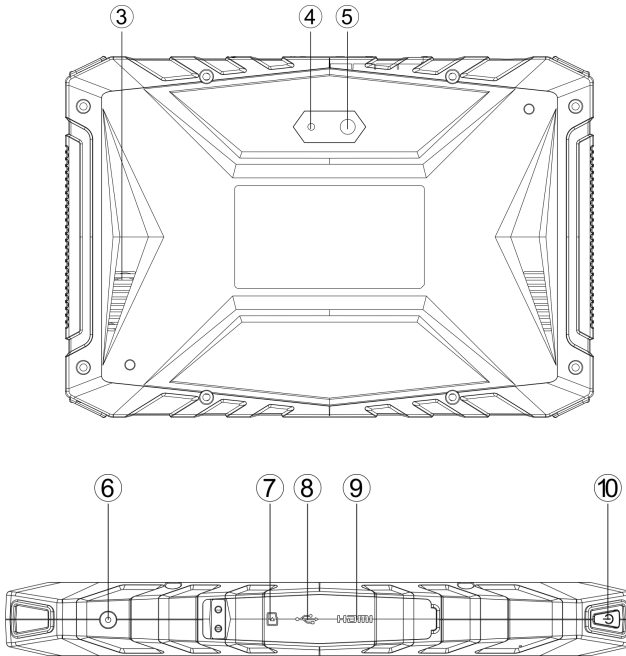

No.	Name	Description
③	External horn hole	Used for playing outside voice
④	Camera	Used for taking pictures or recording videos
⑤	Flashlight	Used for providing light when light is weak
⑥	DC Power port	Used for tablet charging or power supply
⑦	TF Card slot	The place to put TF card
⑧	USB Type-C Interface	Used for connecting computer, using the tablet as a USB stick
	USB Interface	Used for connecting the tablet with VCI or connecting U disk

⑨	HDMI Interface	Standard HDMI interface, used to connect the HDTV output
⑩	Power switch	Used for turning on and off tablets, or locking screens

Chapter III VCI BOX Structure

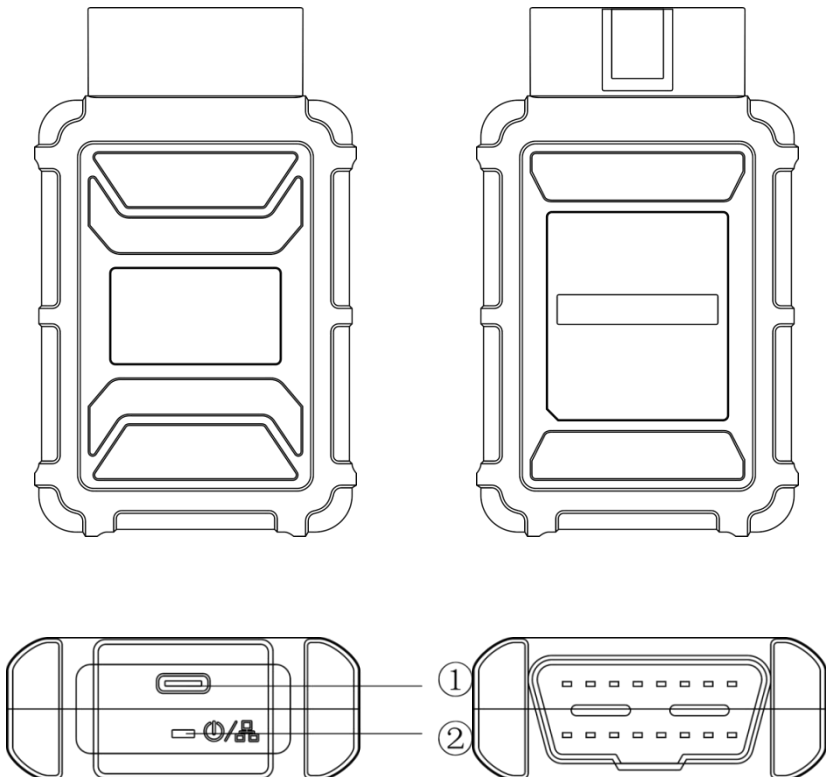

No.	Name	Description
①	USB interface	Connect to tablet PC or upgrade VCI box
②	Diagnostic light	Lights up when connected to vehicle Lights up when connected to tablet

VCI Box Parameters

Item	Description
Communications	BT V.2.1 + EDR USB 2.0
Processor	Cortex-M3 Microcontroller
Frequency	72MHz
Processor Model	STM32F103CBT6
Flash Memory	128KB
RAM	20KB
Wireless Frequency	2.4 GHz
Input Voltage Range	8 V-36VDC
Supply Current	500 mA @ 12 VDC
Operating Temperature	0°C to 40°C (ambient)
Storage Temperature	-20°C to 70°C (ambient)
Bluetooth	Supports Bluetooth 2.0, Bluetooth 4.0

Chapter IV Operation Manual

Product operations for all CanDo products are similar. Here we take a general version as an example and the display content of the host in practical work shall prevail.

4.1 Connection of Power Supply & Main Testing Cable

4.1.1 Host Power Supply

There are 2 ways to connect power and the CanDo main unit.

- ① Connect the power adapter (power adapter)
- ② Dock the CanDo main unit on docking station

4.1.2 Wiring Method

Selection of power supply:

If the diagnostic socket does not have power supply, please choose one power supply connection method to provide power to the host.

If the diagnostic socket has power supply, connection to other power supply cable is not necessary.

CANDO DIAGNOSTIC PLATFORM

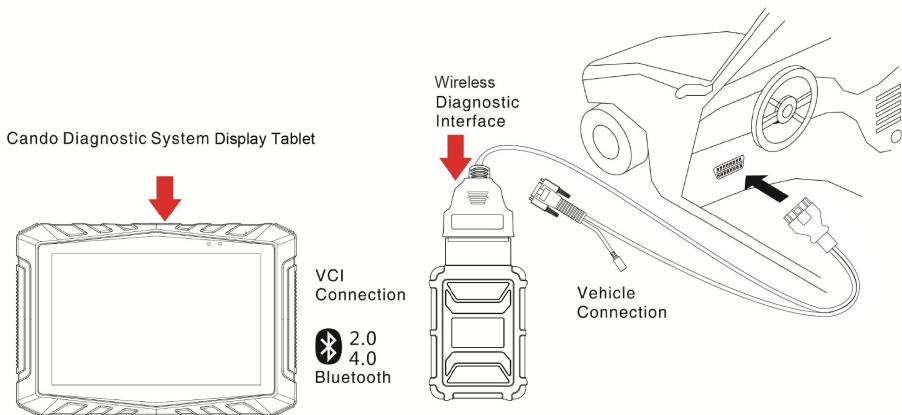

Vehicle necessary conditions:

1. Please confirm the diagnostic socket position and its shape, then check whether it needs external power supply or not.
2. Please select corresponding connectors according to the vehicle models and the shape of diagnostic sockets.

3. One end of the main testing cable is connected to the VCI and the other end is connected to the diagnostic connector.
4. Please insert the diagnostic connector that has been connected to the main testing cable into the vehicle diagnostic socket.
5. Turn on the machine and please confirm if the host is connected to the VCI.
Remark: The automobile diagnostic interface is standard OBD-II interface and two ends of the main testing cable are separately connected to the OBD-II connector and the auto diagnostic tool. The process is completed after inserting the OBD-II connector into the automobile diagnostic socket, please identify it according to the actual vehicle configuration because not all vehicles are equipped with standard OBD-II connectors.

4.1.3 Startup and Shutdown

Startup: Connect the host and power supply by any method mentioned above, and then gently click the power supply button. The host will be started.

Shutdown: After using the device, return to the desktop and gently click the power button to turn off.

Remark: Generally it takes 5-7s to operate when users turn on or off the machine. Pressing the power button for too long or with brute force would lead to button failure.

4.2 Start Interface Menu

Power on the host (press for 5 seconds) through the power switch mentioned above; then click the APP of C-Pro to enter the main interface.

4.2.1 Main Interface

There are differences between models, software systems and menu in CanDo series models. The actual configuration displayed in the product shall prevail and this manual only takes some models as examples. The actual interface shall prevail.

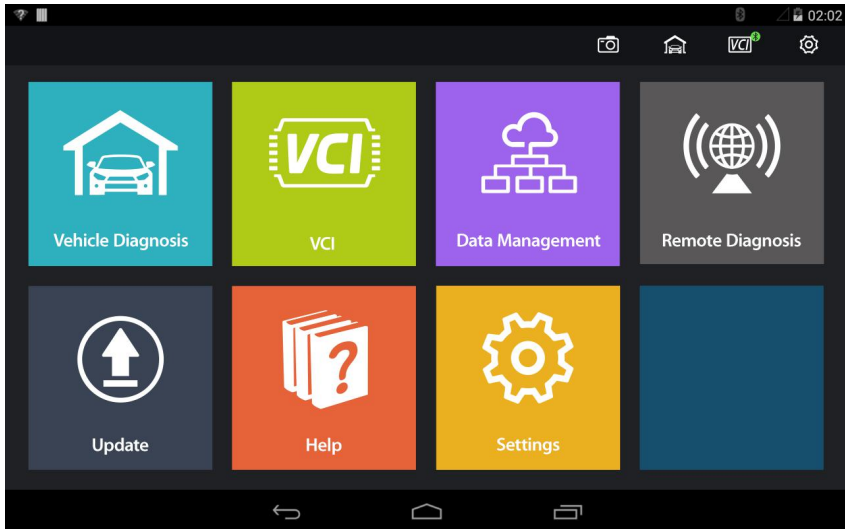

4.2.2 Vehicle Diagnosis

After connecting to the vehicle diagnostic port and selecting the model series, appropriate models of testing can be selected. After entering the model, read fault code, erase fault code, read data stream, actuation test and other advanced functions can be performed.

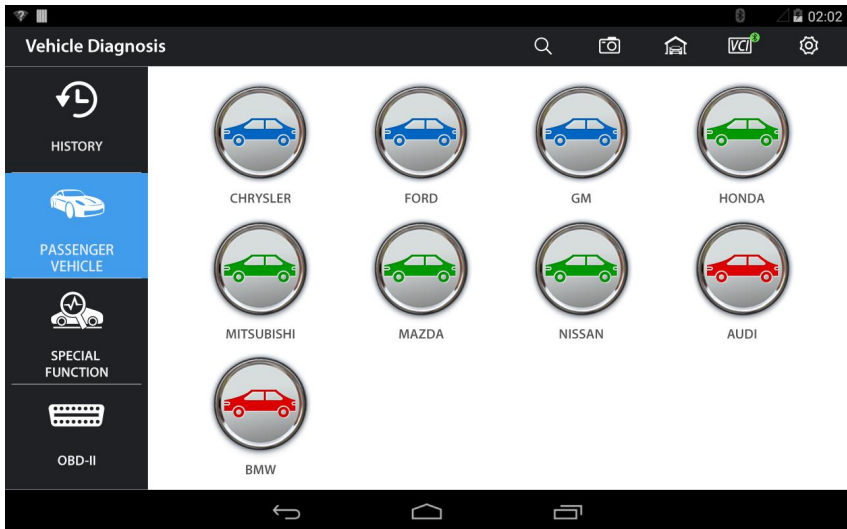

4.2.3 VCI Connection

1. Bluetooth

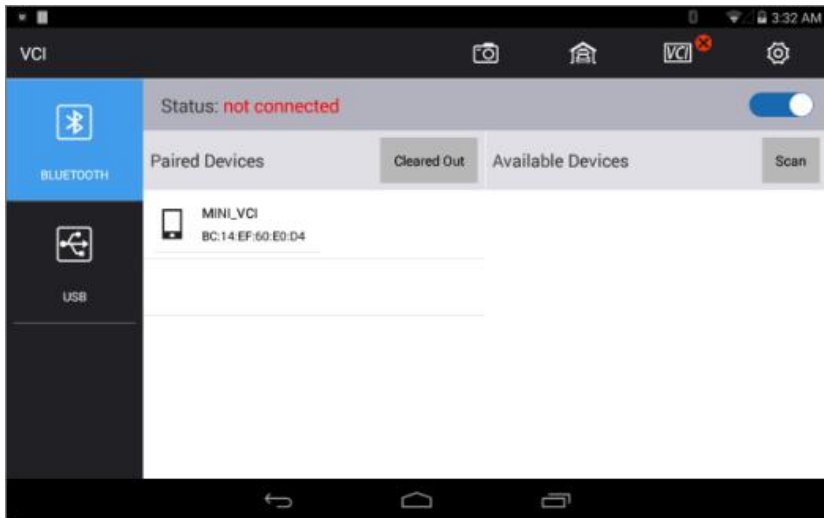

2. USB

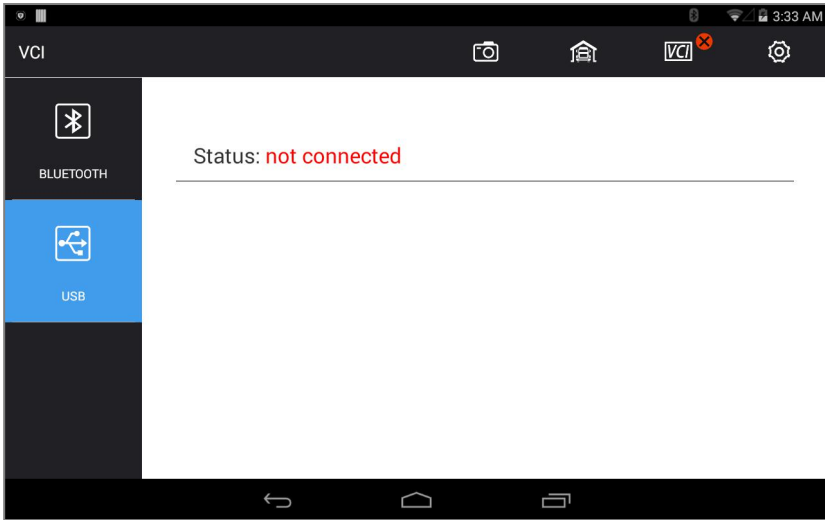

4.2.4 Data Management

Data management is the module for storing picture, video, model version, ect., for user's reference.

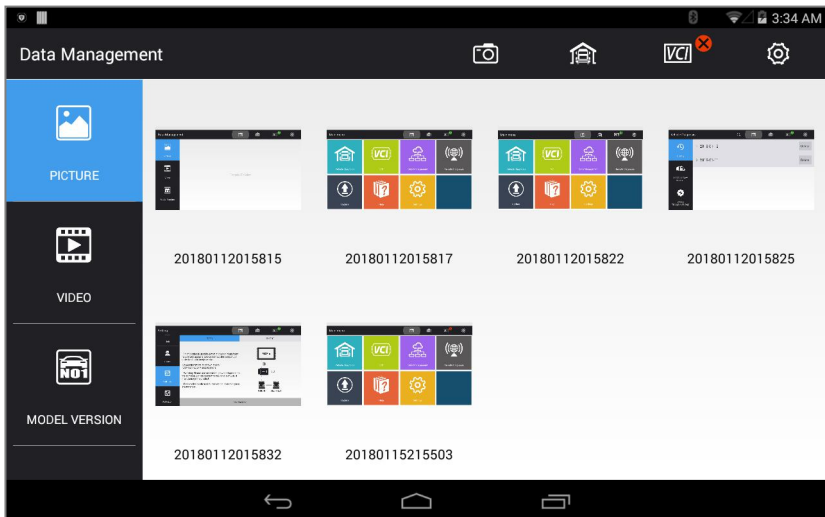

4.2.5 Remote Diagnosis

This function allows our technical staff to connect to your host through the network remotely to help you diagnose the vehicle.

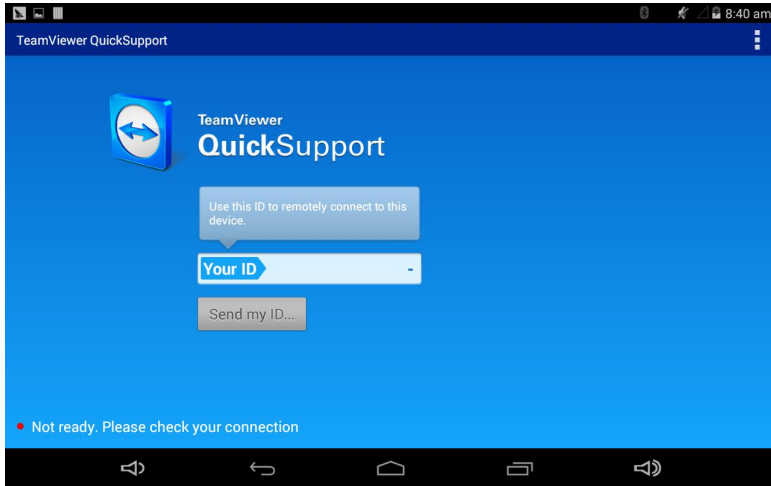

4.2.6 Update

Update the diagnostic software by connecting to Wi-Fi to get up-to-date functions.

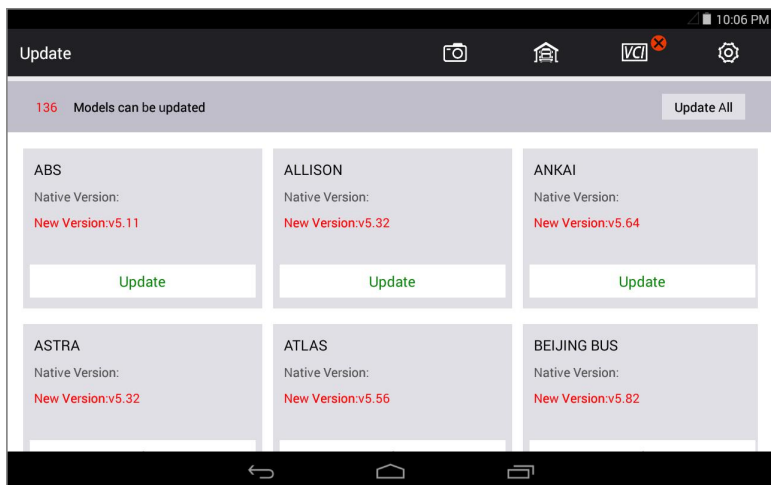

4.2.7 Help

Here we have built-in machine instructions for user's reference.

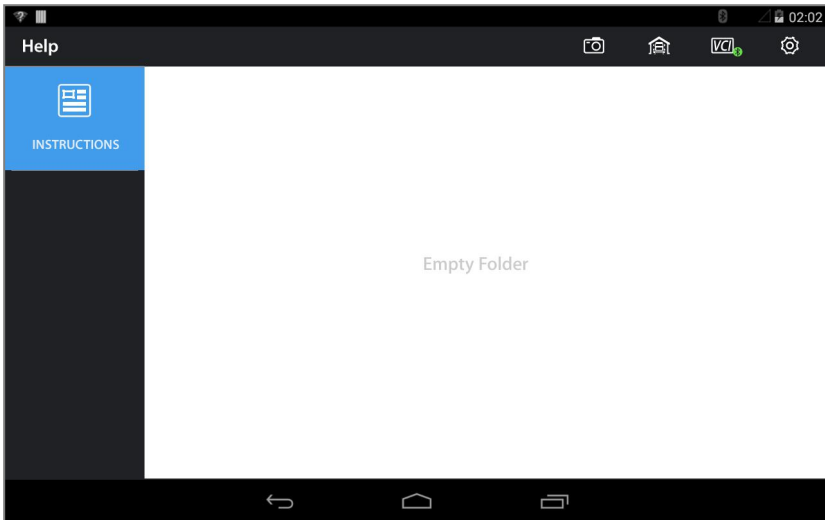

4.2.8 Setting

A module for setting language, unit, user information and viewing tablet information.

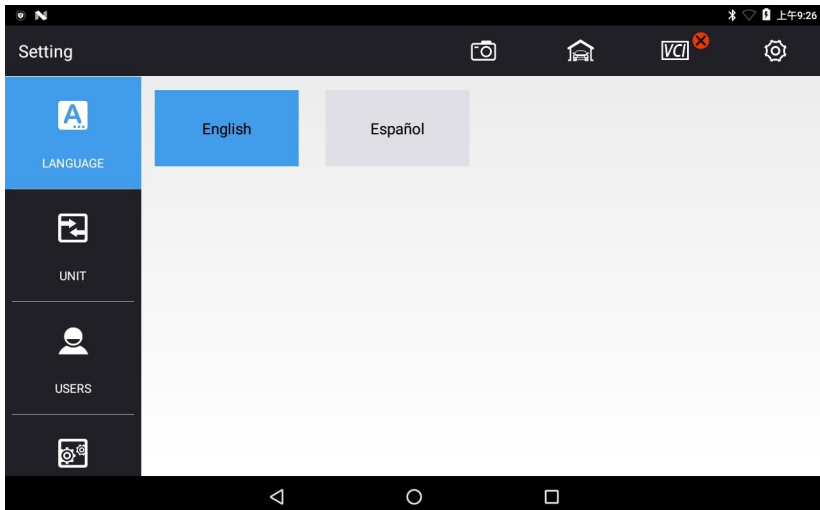

1. Language Settings

C-Pro supports English and Spanish, select either of them as needed.

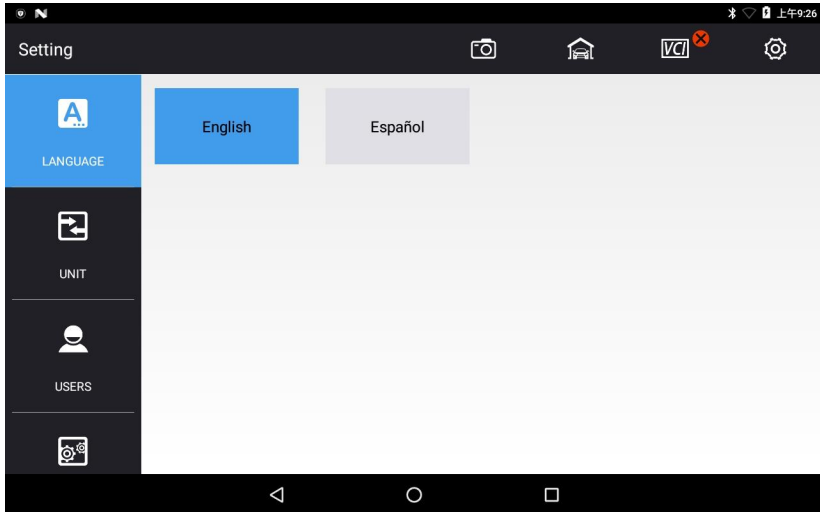

2. Unit

Set the live data unit in the diagnostic software. You can select Metric or English as needed.

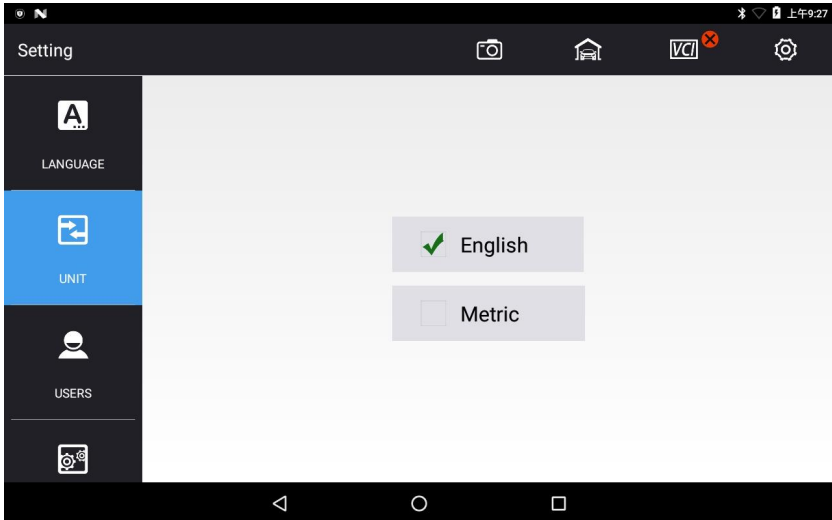

3. Users

Set your personal information: name, phone, email, address, and so on.

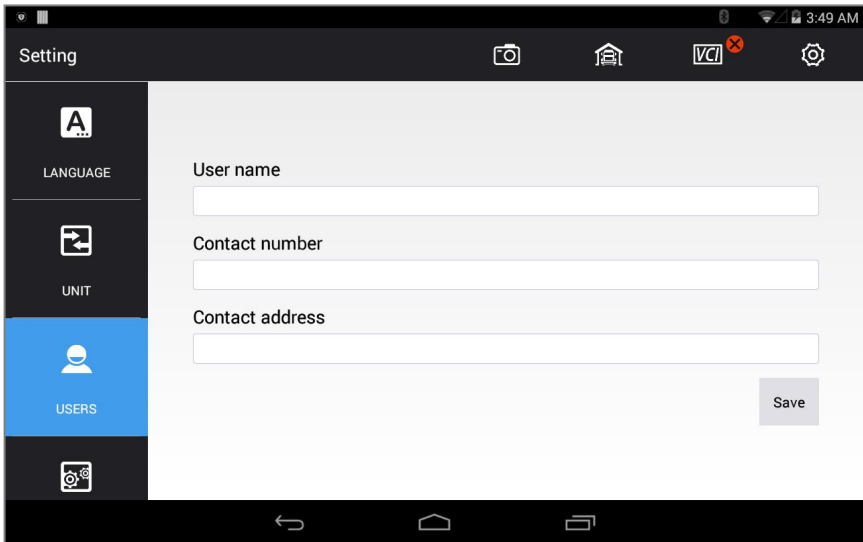

4. Activation

After your purchase, you can permanently activate the product.

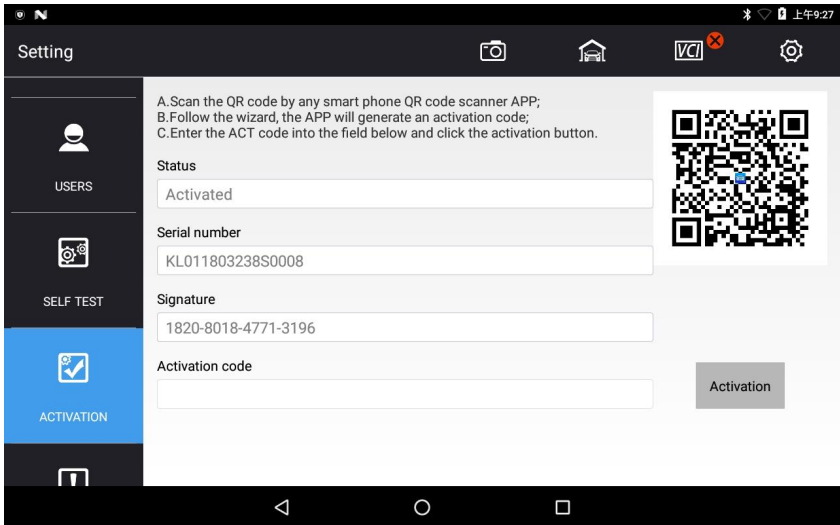

5. About Tablet

This module shows system information, activation status, storage status, etc.

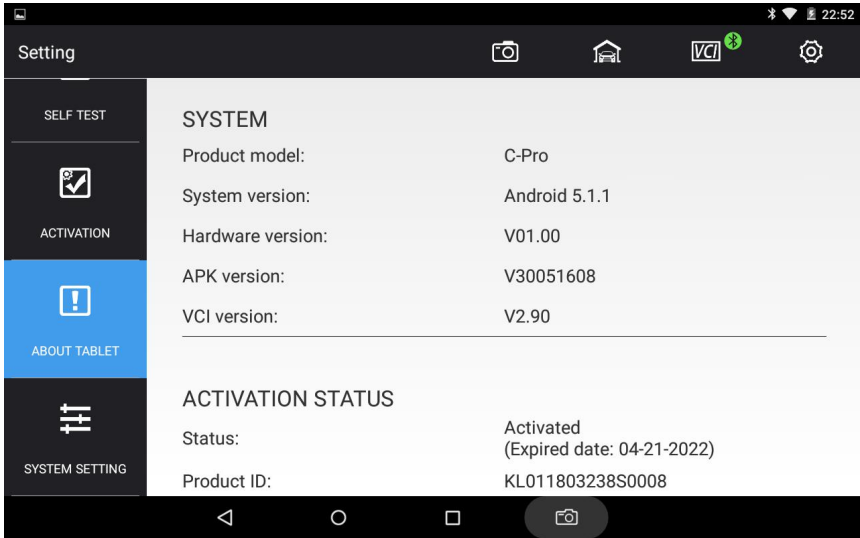

6. System Settings

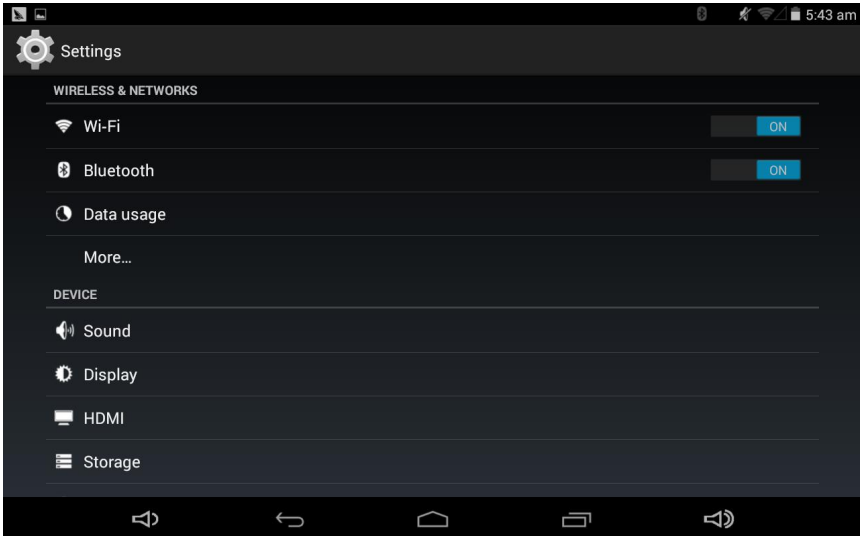

Chapter V Update

Customers who have purchased the CanDo product will need to regularly upgrade it.

1. Click [Update].

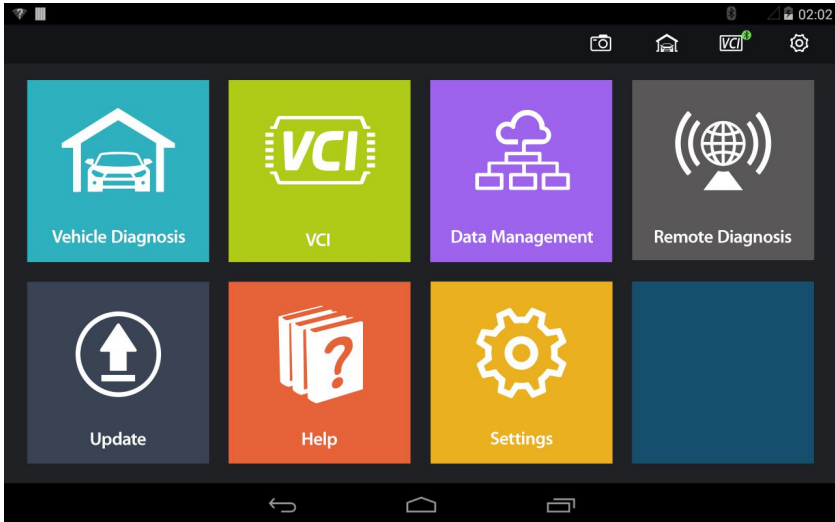

2. Check whether a new model version is available.

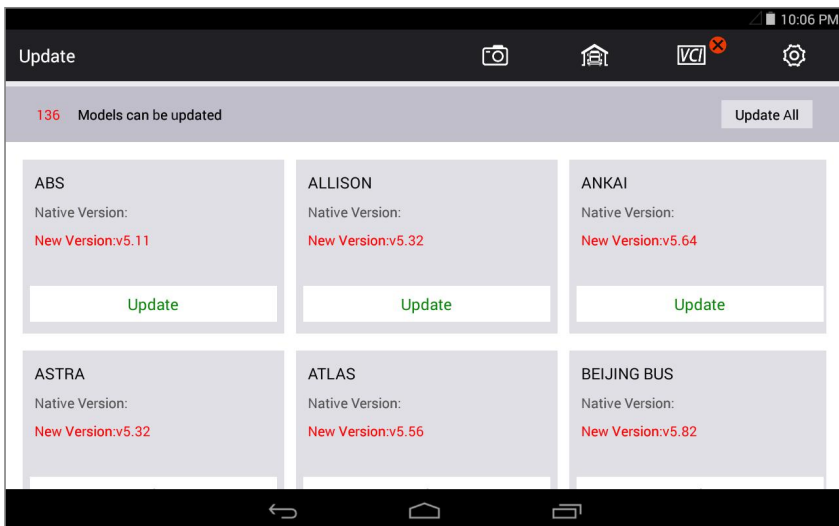

3. Click Update for the corresponding items.

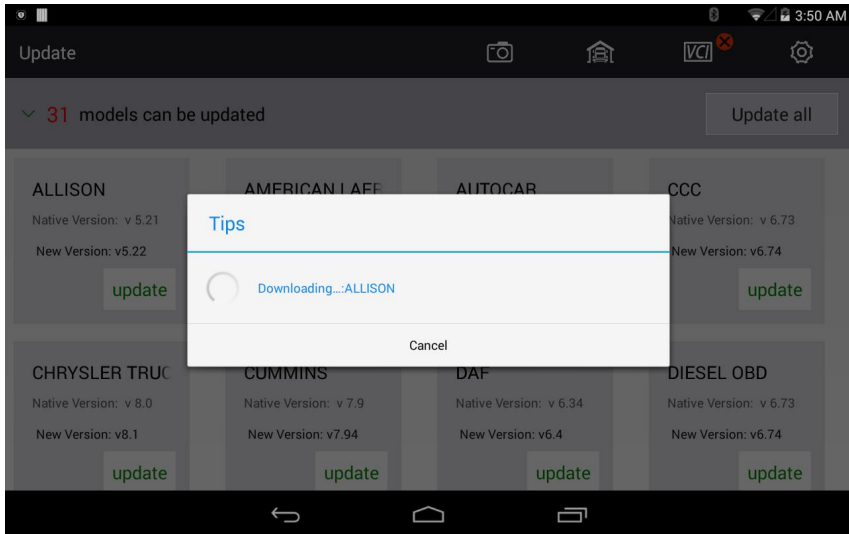

Chapter VI Compliance Information

FCC COMPLIANCE

FCC ID: 2AKNY-IDSCPRO

FCC Statement

This equipment has been tested and found to comply with the limits for a Class B digital device, pursuant to Part 15 of the FCC Rules. These limits are designed to provide reasonable protection against harmful interference in a residential installation. This equipment generates uses and can radiate radio frequency energy and, if not installed and used in accordance with the

instructions, may cause harmful interference to radio communications. However, there is no guarantee that interference will not occur in a particular installation. If this equipment does cause harmful interference to radio or television reception, which can be determined by turning the equipment off and on, the user is encouraged to try to correct the interference by one or more of the following measures:

- Reorient or relocate the receiving antenna.
- Increase the separation between the equipment and receiver.
- Connect the equipment into an outlet on a circuit different from that to which the receiver is connected.
- Consult the dealer or an experienced radio/TV technician for help.

This device complies with part 15 of the FCC Rules. Operation is subject to the following two conditions:

- (1) This device may not cause harmful interference;
- (2) This device must accept any interference received, including interference that may cause undesired operation.

Changes or modifications not expressly approved by the party responsible for compliance could void the user's authority to operate the equipment.

SAR tests are conducted using

standard operating positions accepted by the FCC with the C-Pro transmitting at its highest certified power level in all tested frequency bands, although the SAR is determined at the highest certified power level, the actual SAR level of the phone. While operating can be well below the maximum value, in general, the closer you are to a Wireless base station antenna, the lower the power output. Before a new model phone is available for sale to the public, it must be tested and certified to the FCC that it does not exceed the exposure limit established by the FCC, Tests for each phone are performed in positions and locations (e.g. at the ear and worn on the body) as required by the FCC.

For body worn operation, this model C-Pro has been tested and meets the FCC RF exposure. Guidelines when used with an accessory designated for this product or when used with an accessory that Contains no metal and that positions the handset a minimum of 1 cm from the body.

Non-compliance with the above restrictions may result in violation of RF exposure guidelines.

Annex: Diagnostic Interface Definition and Description of Standard OBD-II

1. OBD-II General Introduction

OBD-II is the abbreviated name of ON-BOARD DIAGNOSTICS-II. The first generation of diagnostic system is before 1993, and the diagnostic socket, fault codes, diagnostic function of each manufacturer was all different, which caused difficulties for repair personnel. American Society of Automotive Engineers (SAE) developed a set of standards and this set of standards certified by the "Environmental Protection Agency" (EPA) and "California Resources

Association" (CARB). This standard requires each manufacturer to provide uniform diagnostic mode and sockets in accordance with standard OBD-II. Since then diagnostic test can be performed on variable vehicles by one instrument.

OBD-II is a standard stipulated by California, cars from Europe, America, and Japan should all comply with the standard. At present, mainland China and Taiwan also adopted this standard. As a result of complying it, using instruments is simplified for technician. We should understand the characteristics of OBD-II in-depth. According to the development of automobile communication, the world's most models are based on the OBD standards currently

2. OBD-II Features

(1) Unified diagnostic socket shape is 16 PIN (needle), as shown below.

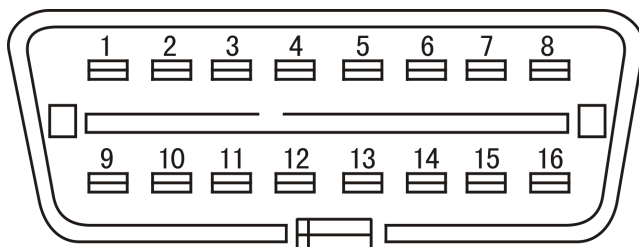

(2) With a numerical analysis and data transmission function(DATA LINK CONNECTOR-DLC).

(3) Unified fault codes and significance.

(4) With a driving recorder function.

(5) With a redisplay fault code memory function.

(6) Clear fault codes directly by the instrument function.

3. DLC (Data Transmission Connector) Diagnostic Socket Unified Standard

(1) DLC diagnostic socket unified as standard 16PIN, mounted in the cab, under the driver side instrument panel.

(2) There are two standard DLC pins: ISO - European standard (INTERNATIONAL STANDARDS ORGANIZATION 9141-2) , use 7#, 15# pin to transfer data.

Each terminal function of OBD-II diagnostic blocks shown in Table 1.

Table: OBD-II Terminal Function

Terminal	Function Description	Terminal	Function Description
1	SAE J2411, GM single wire CAN, GM single line CAN-BUS	9	when 7th pin is not convenient to use, enable *KWP1281 or KWP2000 Protocol diagnostic line (K line)
2	ISO11519-4 (Bus+)(SAE J1850),and 10 th pin used simultaneously	10	ISO 11519-4 (Bus-)(SAE J1850)
3	CCD-BUS network cable H line	11	CCD-BUS network cable L line
4	Car body directly grounding	12	Factory retained
5	Signal circuit grounding	13	Factory retained
6	ISO 15765-4, CAN-BUS high speed diagnostic line (CAN-H line)	14	ISO15765-4, CAN-BUS high speed diagnostic line (CAN-L line)
7	KWP1281 or KWP2000 protocol diagnostic line (K line)	15	KWP1281 or KWP2000 protocol diagnostic line (L line)

8	Factory retained	16	Connect battery “+” pole
----------	------------------	-----------	--------------------------

For more product introduction and help, please visit CanDo official website www.CanDointl.com.

Chapter VII Warranty

Dear CanDo users, welcome to choose CanDo products. In order to make better use of the product, we recommend you to maintain your product and use it according to the user manual each time. If requirements are met, the product will serve you longer.

1. Under the premise that the following terms and conditions are met and you have improved your real information via machine activation or user registration, warranty services will be provided by CanDo International, Inc. (hereinafter referred to as the "CanDo only") for a defective product material or workmanship.

2. Confirm that you carefully read the product warranty terms, for CanDo International, Inc. will regard you as accepted the terms of the warranty by completing the information on CanDo official website.

3. Products must be purchased from reseller authorized by CanDo International, Inc., if it is from irregular channels, buyers have to bear the cost of product repair services.

4. The following are not covered by the warranty: Product manual, inside and outside packaging, promotional gift items, printing supplies and other consumable items.

5. Since the data of purchase (valid Proof-of-Purchase and warranty card), you can choose to repair the product or replace it with same models if non artificial damage of performance failure occurred in one month.

6. Any of the following cases, your product will not be able to enjoy free warranty service.

1) Failure, defect or flaw that not belong to the quality of CanDo International, Inc. products: including improper operations, crash, fall, self disassembly, connection of improper accessories, damages owing to improper transport or storage of the product, erosion and corrosion that caused by infiltration of liquid or food.

2) The natural wear and tear of product: including but not limited to cover, keypad, LCD touch screens and accessories.

3) Inconsistent of Product host serial number and warranty card product

serial number, product quality inspection tag or barcode removed, altered or damaged.

4) Maintenance and modification without the approval of CanDo International, Inc..

7. The product quality problem or failure occurred within the warranty period, you can take the following measures.

1) You can perform self-test for the product according to products help information. If there are no hardware quality problems, try to upgrade the product program.

2) You can dial CanDo International, Inc. to obtain the correct service information. This includes obtaining an RMA# (Return Materials Authorization) prior to sending the unit in for repairs. Product received without an RMA# will be rejected.

3) After obtaining the company's effective reply, the product must mailed to our designated address (see full address on the official website of CanDo International, Inc.) for repair and maintenance, otherwise your product can not receive timely repair and maintenance. And you have to take the lose of your product. Please make sure to mark the outside of the box with the RMA# provided.

8. During the process of warranty service, you will bear the costs associated with delivery or maile to CanDo International, Inc., including product packaging, transportation, insurance and other expenses.

9. Enjoying your free warranty service under this warrant clause is the only measure for the losses due to product defect within the product warranty period. CanDo International, Inc. shall assume no responsibility for your direct or indirect loss.

10. All warranty information, product features and specification changes will be posted on CanDo International, Inc. latest promotional materials and web site without further notice.



CanDo

CanDo International, Inc.



CanDo

CanDo International, Inc.

Certification

This product has been inspected and certified to meet the company's quality standards.

Product name	C-Pro
Product serial number	
Date of production	
Inspector	



Warranty card

Product name	C-Pro
Product serial number	
Purchase date	

Company name: _____

User address: _____

Contact person: _____

Contact number: _____

