

ATTENTION!

READ BEFORE ATTACHING THE AIR HOSE

HVLP AIR SUPPLY REQUIREMENTS

FULL SIZE GUN: 30 PSI inlet pressure provides 10 PSI at the air cap. Consumes 13 CFM.

TOUCHUP GUN: 30 PSI inlet pressure provides 10 PSI at the air cap. Consumes 8 CFM.

NOTE: USE 5/16" OR LARGER I.D. AIR HOSES

¡ATENCIÓN!

LEA ANTES DE FIJAR LA MANGUERA DE AIRE

REQUISITOS DE SUMINISTRO DE AIRE DE ALTO VOLUMEN BAJA PRESIÓN (HVLP)

PISTOLA HVLP: Una presión de entrada de 30 PSI (libras por pulgada cuadrada) proporciona 10 PSI en la boquilla. Consume 13 CFM (pies cúbicos por minuto).

PISTOLA RE-TOQUE: Una presión de entrada de 30 PSI (libras por pulgada cuadrada) proporciona 10 PSI en la boquilla. Consume 8 CFM (pies cúbicos por minuto).

NOTA: UTILICE MANGUERAS CON DIÁMETRO INTERNO DE 7.94 MM (5/16 DE PULG.) O MÁS GRANDE

ATTENTION !

LIRE AVANT DE FIXER LE TUYAU D'ARRIVÉE D'AIR

HVLP AIR SUPPLY REQUIREMENTS EXIGENCES HVLP CONCERNANT L'ALIMENTATION EN AIR

PISTOLET Á PEINTURE: Une pression à l'admission de 2,07 BAR (30 PSI) donne une pression de 0,69 BAR (10 PSI) à l'anneau défecteur. Utilise 0,37 m³ (13 pi³) à la minute.

PISTOLET DE RETOUCHE: Une pression à l'admission de 2,07 BAR (30 PSI) donne une pression de 0,69 BAR (10 PSI) à l'anneau défecteur. Utilise 0,23 m³ (8 pi³) à la minute.

REMARQUE : UTILISER UN TUYAU D'UN DIAMÈTRE INTÉRIEUR DE 7,94 MM (5/16 PO) AU MINIMUM.

ATTENTION!

READ BEFORE ATTACHING THE AIR HOSE

HVLP AIR SUPPLY REQUIREMENTS

FULL SIZE GUN: 30 PSI inlet pressure provides 10 PSI at the air cap. Consumes 13 CFM.

TOUCHUP GUN: 30 PSI inlet pressure provides 10 PSI at the air cap. Consumes 8 CFM.

NOTE: USE 5/16" OR LARGER I.D. AIR HOSES

SET-UP AND ADJUSTMENT INSTRUCTIONS

1. Attach cup to gun and flush solvent through gun to remove oils.
2. Tighten packing nut—see instructions.
3. Fully open fan and fluid needle controls (turn counter-clockwise). 
4. If desired, attach air adjusting valve with gauge and/or quick disconnect to air inlet, then attach hose.
5. Spray test and adjust air pressure, fan size, and fluid flow as required. Recommended spray distance is 6-8 inches.

WARNING

A failure resulting in injury or damage may be caused by pressure beyond top of scale, excessive vibration or pressure pulsation, excessive instrument temperature, corrosion of the pressure containing parts or other misuse of the air adjusting valve with gauge.

PACKING ADJUSTMENT INSTRUCTIONS

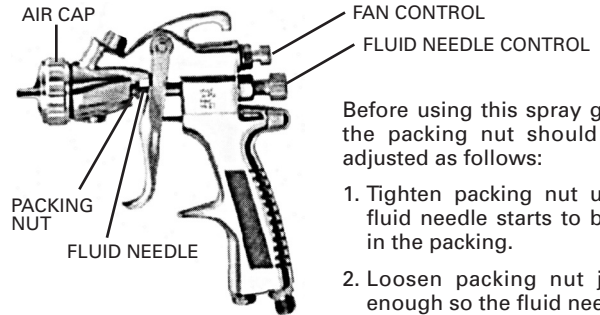

Before using this spray gun, the packing nut should be adjusted as follows:

1. Tighten packing nut until fluid needle starts to bind in the packing.
2. Loosen packing nut just enough so the fluid needle moves freely.

The packing nut is intentionally left loose so the PTFE packing does not take a "set" before the spray gun is used. This allows full utilization of the packing.

Spray a test area. Turn the fluid needle adjusting knob counterclockwise until a full coat is obtained.

If the finish is too sandy and dry, the material flow may be too low for the atomization air pressure being used. Turn the fluid needle adjusting knob counterclockwise to increase fluid flow.

If the finish sags, there is too much material flowing for the atomization air pressure being used. Turn the fluid needle adjusting knob clockwise to decrease fluid flow.

Pattern width can be altered by turning spreader adjustment valve, either clockwise to decrease the width or counterclockwise to increase the width.

Adjust inlet air pressure to provide a uniform dispersion of atomized paint throughout the pattern. Keep air pressure as low as possible to minimize bounce-back and overspray. Excessive pressure will result in split spray patterns. Inadequate pressures will cause heavy centered patterns and poor atomization.

Fluid Tip Size (mm)	Applications
1.0	General purpose, light to medium viscosity material.
1.3	Top coats.
1.5	Top coats and primer sealers.
1.8	Primers.

CLEANING

For routine cleaning, it is not necessary to remove cup from gun. Remove lid and properly dispose of any excess paint. Pour in a small amount of clean solvent. The amount will vary with different coatings and solvents. Reinstall lid. Shake cup to wash down the inside surfaces. Pull trigger to allow some solvent to be flushed through gun. Remove lid and pour out dirty solvent. Add a small amount of clean solvent and repeat procedure. Wipe exterior of lid with a clean cloth and clean solvent.

If a paint filter was used in the bottom of the cup outlet, it should be removed and cleaned at this time.

To clean air cap and fluid tip, brush exterior with a stiff bristle brush. If necessary to clean cap holes, use a broom straw or toothpick if possible. If a wire or hard instrument is used, extreme care must be used to prevent scratching or burring of the holes which will cause a distorted spray pattern.

To clean fluid passages, remove excess material at source, then flush with a suitable solvent. Wipe gun exterior with a solvent dampened cloth. Never completely immerse in solvent as this is detrimental to the lubricants and packings.

PREVENTIVE MAINTENANCE

Spray Gun Lubrication



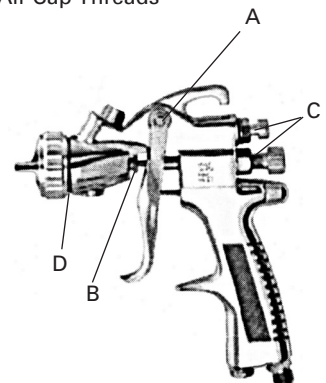

Apply a drop of spray gun lube at trigger bearing stud and the stem of the air valve. The shank of the fluid needle where it enters the packing nut should also be oiled. The fluid needle packing should be kept soft and pliable by periodic lubrication. Make sure the baffle and retaining ring threads are clean and free of foreign matter. Before assembling retaining ring to baffle, clean the threads thoroughly, then add two drops of spray gun lube to threads. The fluid needle spring and air valve spring should be coated with a very light grease, making sure that any excess grease will not clog the air passages. For best results, lubricate the points indicated, daily.

- A. Trigger Points
- B. Packing
- C. Adjusting Valve
- D. Baffle/Air Cap Threads





WARNING

**The following hazards may occur during the normal use of this equipment.
Please read the following chart before using this equipment.**

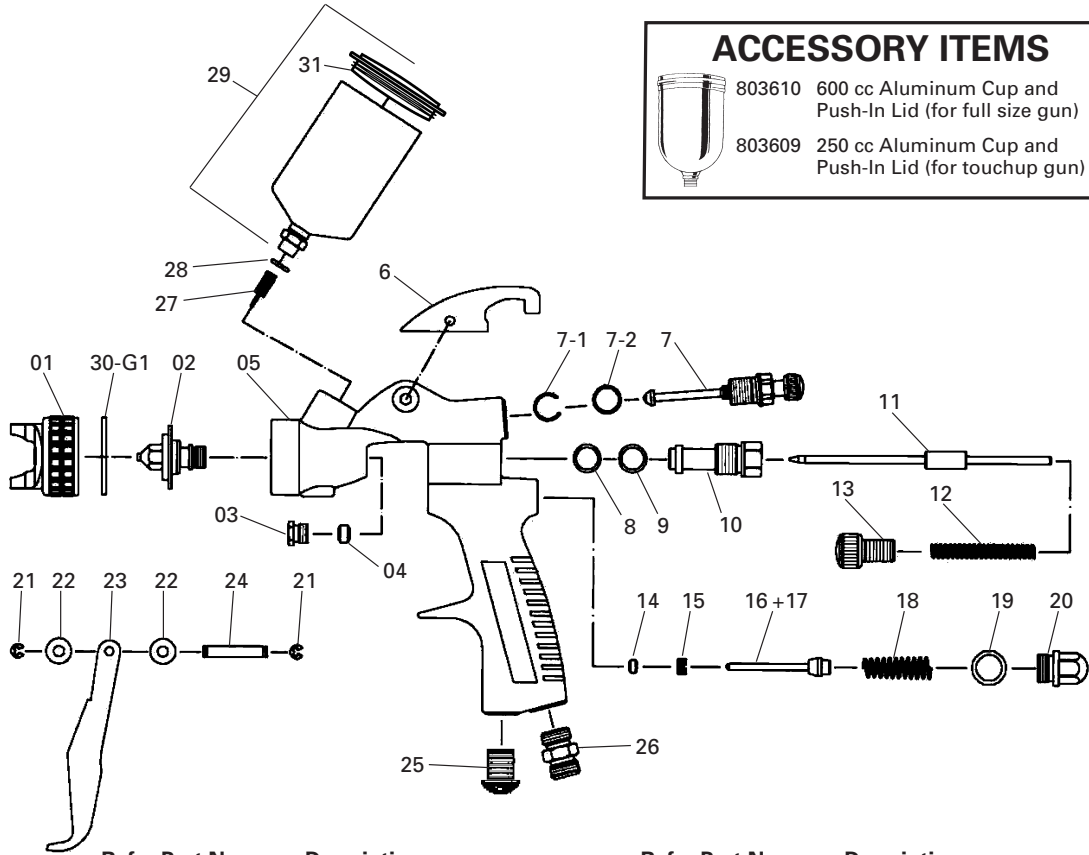
HAZARD	CAUSE	SAFEGUARDS
Fire 	Solvent and coatings can be highly flammable or combustible especially when sprayed.	<p>Adequate exhaust must be provided to keep air free of accumulations of flammable vapors.</p> <p>Smoking must never be allowed in the spray area.</p> <p>Fire extinguishing equipment must be present in the spray area.</p>
Solvent Spray 	During use and while cleaning and flushing, solvents can be forcefully expelled from fluid and air passages. Some solvents can cause eye injury.	Wear eye protection.
Inhaling Toxic Substances 	Certain materials may be harmful if inhaled, or if there is contact with the skin.	<p>Follow the requirements of the Safety Data Sheet (SDS) supplied by your coating material manufacturer.</p> <p>Adequate exhaust must be provided to keep the air free of accumulations of toxic materials.</p> <p>Use a mask or respirator whenever there is a chance of inhaling sprayed materials. The mask must be compatible with the material being sprayed and its concentration. Equipment must be as prescribed by an industrial hygienist or safety expert, and be NIOSH approved.</p>
Explosion Hazard - Incompatible Materials 	Halogenated hydrocarbon solvents - for example; methylene chloride and 1,1,1, - Trichloroethane are not chemically compatible with the aluminum that might be used in many system components. The chemical reaction caused by these solvents reacting with aluminum can become violent and lead to an equipment explosion.	Guns with stainless steel internal passageways may be used with these solvents. However, aluminum is widely used in other spray application equipment - such as material pumps, regulators, valves, and this gun and cup. Check all equipment items before use and make sure they can also be used safely with these solvents. Read the label or data sheet for the material you intend to spray. If in doubt as to whether or not a coating or cleaning material is compatible, contact your material supplier.
General Safety	Improper operation or maintenance of equipment.	Operators should be given adequate training in the safe use and maintenance of the equipment (in accordance with the requirements of NFPA-33, Chapter 15). Users must comply with all local and national codes of practice and insurance company requirements governing ventilation, fire precautions, operation, maintenance, and housekeeping. These are OSHA Sections 1910.94 and 1910.107 and NFPA-33.
Cumulative Trauma Disorders ("CTD's") CTD's, or musculoskeletal disorders, involve damage to the hands, wrists, elbows, shoulders, neck, and back. Carpal tunnel syndrome and tendonitis (such as tennis elbow or rotator cuff syndrome) are examples of CTD's.	<p>Use of hand tools may cause cumulative trauma disorders ("CTD's").</p> <p>CTD's, when using hand tools, tend to affect the upper extremities. Factors which may increase the risk of developing a CTD include:</p> <ol style="list-style-type: none"> 1. High frequency of the activity. 2. Excessive force, such as gripping, pinching, or pressing with the hands and fingers. 3. Extreme or awkward finger, wrist, or arm positions. 4. Excessive duration of the activity. 5. Tool vibration. 6. Repeated pressure on a body part. 7. Working in cold temperatures. <p>CTD's can also be caused by such activities as sewing, golf, tennis, and bowling, to name a few.</p>	<p>Pain, tingling, or numbness in the shoulder, forearm, wrist, hands, or fingers, especially during the night, may be early symptoms of a CTD. Do not ignore them. Should you experience any such symptoms, see a physician immediately. Other early symptoms may include vague discomfort in the hand, loss of manual dexterity, and nonspecific pain in the arm. Ignoring early symptoms and continued repetitive use of the arm, wrist, and hand can lead to serious disability. Risk is reduced by avoiding or lessening factors 1-7.</p>



ACCESSORY ITEMS	
	803610 600 cc Aluminum Cup and Push-In Lid (for full size gun)
	803609 250 cc Aluminum Cup and Push-In Lid (for touchup gun)

Ref.	Part No.	Description
01	—	AIR CAP w/Ring
02	—	FLUID NOZZLE
●03	—	NUT
●04	—	GASKET
05	—	GUN BODY
06	—	HOOK
07	—	FAN CONTROL
●7-1	—	C-CLIP (2 pcs.)
●7-2	—	O-RING (2 pcs.)
●08	—	GASKET
●09	—	O-RING
10	—	HOUSING
11	—	PAINT NEEDLE
●12	—	SPRING
●13	—	KNOB, FLUID CONTROL
●14	—	GASKET
●15	—	SCREW
●16+17	—	VALVE STEM COMPLETE
●18	—	SPRING

Ref.	Part No.	Description
●19	—	O-RING
20	—	AIR VALVE NUT
●21	—	E-RING (2 pcs.)
22	—	WASHER (2 pcs.)
23	—	TRIGGER
●24	—	TRIGGER STUD
25	—	PLUG
26	—	AIR INLET FITTING
27	—	FILTER
▲●28	—	GASKET for Fitting (2 pcs.)
29	803610	600cc ALUM. CUP & LID
	803609	250cc ALUM. CUP & LID
●30-G1	—	GASKET for Air Cap
31	803591	600cc PUSH-IN LID (Kit of 2 ea.)
	803590	250cc PUSH-IN LID (Kit of 2 ea.)

- Gun Repair Kit: Full Size (802425) Touchup (802426)
- ▲ Cup Fitting Gasket Kit: Full Size and Touchup (803615)

Order No.	Description
803013	StartingLine Tip & Needle (1.3 mm)
803015	StartingLine Tip & Needle (1.5 mm)
803018	StartingLine Tip & Needle (1.8 mm)

WARRANTY
 This product is covered by DeVilbiss' 6 Month Limited Warranty.

Carlisle Fluid Technologies reserves the right to modify equipment specifications without prior notice. DeVilbiss®, Ransburg®, MS®, BGK®, BINKS®, TEKNA®, FinishLine®, StartingLine®, CamAir®, CVi®, PLUS®, GTi®, and PRI® are registered trademarks of Carlisle Fluid Technologies, Inc.



DeVilbiss Automotive Refinishing is part of Carlisle Fluid Technologies, a global leader in innovative finishing technologies. For technical assistance or to locate an authorized distributor, contact one of our international sales and customer support locations.

USA/Canada
 www.autorefinishdevilbiss.com
 askus@carlisleleft.com
 Toll Free Tel: 1-800-445-3988
 Toll Free Fax: 1-800-445-6643

Mexico
 www.autorefinishdevilbiss.com.mx
 Toll Free Tel: 1-888-835-6232 USA

