

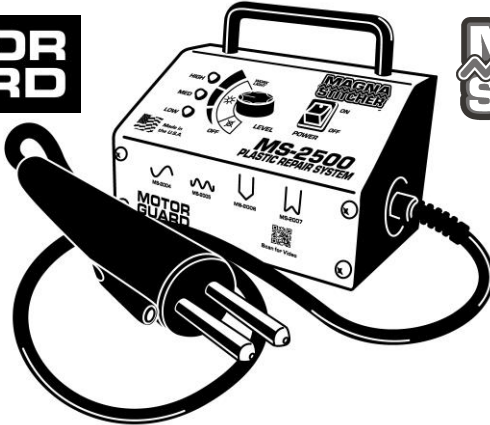

INSTRUCTIONS

MAGNA-STITCHER™ Plastic Repair System Model MS-2500

**MOTOR
GUARD**



**MAGNA
STITCHER**
TM

 **WARNING:** Read and understand all instructions before attempting to operate tool. Failure to follow instructions may result in electric shock, fire and/or serious personal injury.

IMPORTANT SAFETY INSTRUCTIONS



To reduce the risk of serious injury and/or property damage, observe all warnings and instructions while operating the tool. Keep work area clean and well lit. Maintain tool in top condition and obtain service from manufacturer if tool malfunctions. Use only accessories and replacement parts that are provided by the manufacturer.



This tool must be connected to a properly grounded outlet installed in accordance with all local codes and ordinances. Never remove the grounding prong or modify the plug in any way. Do not use adapter plugs. Consult an electrician if you are in any doubt as to whether the plug is properly grounded. Avoid bodily contact with grounded surfaces.



Always wear proper personal protection when operating welder. A full face shield per ANSI Z87.1-2003 standard is required at all times to protect face and eyes against injury from flying parts. Adequate gloves and clothing are required to reduce the risk of burns. Allow parts to cool before handling.



Do not operate tool in explosive atmospheres, such as in the presence of flammable liquids, gases or dust. Welders create sparks which may ignite dust or fumes. Use in well ventilated areas only. Welders generate heat which can ignite surrounding materials causing fires.

SAVE THESE INSTRUCTIONS

IF YOU HAVE ANY QUESTIONS ABOUT THE OPERATION OF PRODUCT CALL TOLL FREE
800-227-2822

8:00 am to 5:00 pm - Pacific Time - Monday through Friday

APPLICATION

The Motor Guard Magna Stitcher™ Plastic Repair System can be used to perform structural repair of many plastic parts. The MS-2500 works by welding a rigid stainless steel stake into the surface of the plastic resulting in a permanent repair of the crack. Repairs can be made on flat surfaces, tabs, holes, ribs, inside and outside corners.

The Magna Stitcher™ System can be used to repair Bumpers, Fascias, Spoilers, Headlamp Brackets, Radiator Brackets, Interior Components, Underbody Structures, Wheel Wells, Panel Mounting Tabs and any thermoplastic part. This economical tool can also be used for quick, on-the-vehicle repairs such as mounting tabs, underbody components and other out-of-sight components. Simply stitch and go!



IMPORTANT: Read and understand all warnings and instructions prior to use.

PREPARING MAGNA-STITCHER SYSTEM FOR USE

Connect the unit to an approved power supply, paying careful attention to the safety instructions on the previous page. If an extension cord is needed, it must be a three-wire, grounded cord of the proper amperage. **△ This unit is designed for indoor use only in a clean, dry environment.**

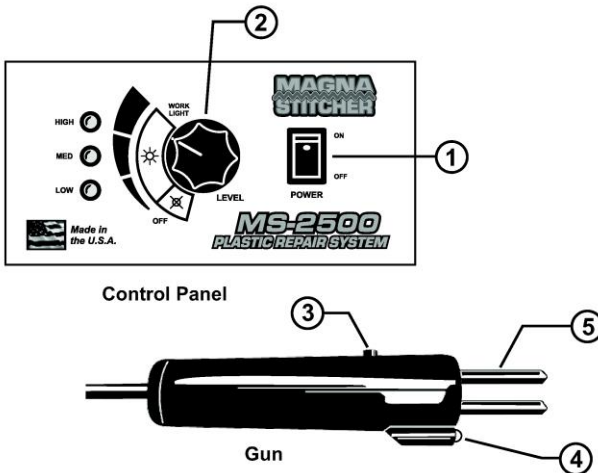

Fig. 1

Turn the unit on by switching the main Power Switch (1) to the On position. Select a power level by rotating the Level Knob (2) to one of the three power positions:

Low Setting	(Green LED)	For thin sections and detailed work
Medium Setting	(Yellow LED)	For general repairs
High Setting	(Red LED)	For thicker sections and heavy work

The Work Lamp (4) will illuminate in any of the three power positions and will remain on whether the Trigger Button (3) is depressed or not. **△ To prevent eye damage, do not stare directly into the light beam and do not point the light directly at others.**

Choose proper stake type according to area to be repaired (see table on back page).

PREPARATION OF WORK AREA

Prepare area to be repaired by removing all dirt, oil and dust. Repairs are generally made on the inside surface of the panel. Removable foil tape may be used on the outer surface to hold the position while stitching.

GENERAL REPAIR PROCEDURE WITH MAGNA STAKES

Insert stake into Electrodes (5) as shown in Figure 2. Three positions are available to insert stakes at different angles.

Place stake against surface to be repaired while applying moderate pressure. Depress the Trigger Button (3) to heat the stake.

While continuing to apply pressure, allow the stake to sink halfway through the thickness of the work piece. After stake is inserted to proper depth, twist the stake slightly to allow it to lock into the panel.

Allow the stake to cool for 2 or 3 seconds before removing tool. Trim exposed ends of stake using wire cutters (Figure 3). **△ Take care while trimming stakes as flying pieces can cause injury to operator or bystanders. Eye protection should be worn at all times** (See Safety Instructions).

Complete cosmetic repair on front of panel as needed.

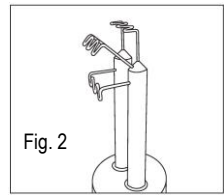

Fig. 2

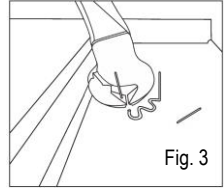

Fig. 3

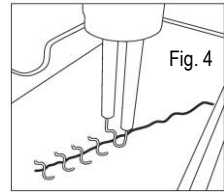

Fig. 4

REPAIR OF FLAT AREAS

Prepare area to be repaired per instructions above. Insert an S-Shaped Magna-Stake™ into the electrodes.

Set stake across crack as shown in Figure 4. Insert stake per instructions above, halfway through panel thickness, and give stake a slight twist before allowing to cool. Space stakes on 1/2 to 3/4 inch intervals or as needed for strength.

Trim stake ends and complete repair on front of panel as needed (See Safety Instructions).

REPAIR OF TABS AND THIN SECTIONS

Prepare area to be repaired per instructions above. Insert an M-Shaped Magna-Stake™ into the electrodes.

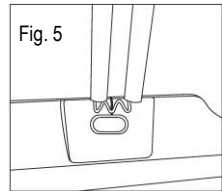

Fig. 5

Set stake across crack as shown in Figure 5. Insert stake per instructions above, halfway through panel thickness, and add additional stakes as needed for strength.

Trim stake ends and complete repair on front of panel as needed (See Safety Instructions).

REPAIR OF INSIDE CORNERS

Prepare area to be repaired per instructions above. Insert a V-Shaped Magna-Stake™ (MS2006) into the electrodes.

Set stake across crack as shown in Figure 6. Insert stake per instructions above, halfway through panel thickness, and give stake a slight twist before allowing to cool. Space stakes on 1/2 to 3/4 inch intervals or as needed for strength.

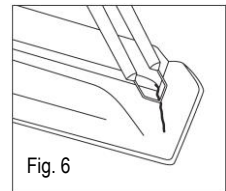

Fig. 6

Trim stake ends and complete repair on front of panel as needed (See Safety Instructions).

REPAIR OF OUTSIDE CORNERS

Prepare area to be repaired per instructions above. Insert a W-Shaped Magna-Stake™ (MS2007) into the electrodes.

Set stake across crack as shown in Figure 7. Insert stake per instructions above, halfway through panel thickness, and give stake a slight twist before allowing to cool. Space stakes on 1/2 to 3/4 inch intervals or as needed for strength.

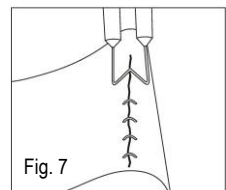
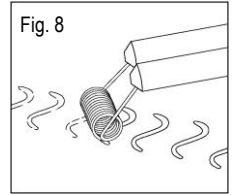

Fig. 7

Trim stake ends and complete repair on front of panel as needed (See Safety Instructions).

SURFACE REPAIR WITH IRONING TIP





Ironing tip may be used to smooth rough areas and build up low areas prior to final repair. Insert Magna-Stitcher™ Ironing Tip (MS2045) into the electrodes as shown in Fig. 8.



Depress Trigger Button (3) to heat the tip. Apply moderate pressure and a slight rotary motion, allowing the spring-like tip to roll over the area to be repaired.

Continue until damaged area is smooth and complete repair using conventional methods.

REPLACEMENT STAKES

	<p>S-Shaped Magna-Stake for repair of flat sections. Rust proof stainless steel.</p>	<p>MS2004 PK/50 MS2014 PK/100</p>
	<p>M-Shaped Magna-Stake for repair of tabs and thin sections. Rust proof stainless steel.</p>	<p>MS2005 PK/50 MS2015 PK/100</p>
	<p>V-Shaped Magna-Stake for repair of inside corners. Rust proof stainless steel.</p>	<p>MS2006 PK/50 MS2016 PK/100</p>
	<p>W-Shaped Magna-Stake for repair of outside corners. Rust proof stainless steel.</p>	<p>MS2007 PK/50 MS2017 PK/100</p>

LIMITED WARRANTY

Motor Guard Corporation assumes the responsibility of providing products that are free from defects in workmanship and material. Should a product fail due to a defect in workmanship or material, Motor Guard Corporation will repair or, at its option, replace the product without charge, other than the transportation charges, provided that the product is returned to the factory, transportation prepaid, within **One (1) Year** of the date of purchase. Please contact Motor Guard Corporation for return authorization and shipping instructions.

This limited warranty does not cover normal wear and tear or damage to the product due to neglect, misuse or accident, nor does it cover any loss, damage or expense, either direct, indirect or consequential, arising from the non-function of this product.



Scan for Video

Motor Guard Corporation
580 Carnegie Street
Manteca, CA 95337
U.S.A.

Toll Free: (800) 227-2822
info@motorguard.com

Hours: Mon-Fri 8:00 am to 5:00 pm PST