

TITAN

PROFESSIONAL TOOLS

FULL LINE CATALOG

HAND TOOLS | AIR TOOLS | IMPACT TOOLS | SHOP EQUIPMENT

TITAN

VAPER

SHOP IRON
BUILT TO GET THE JOB DONE

TEKZ™

BOZEMAN

HAND TOOLS.....	3-72	POWER TOOLS & ACCESSORIES.....	130-144
Adjustable Wrenches	3-4	Power Tools - Corded.....	130-131
Crowfoot Wrenches.....	5	Power Tools Accessories.....	132
Combination Wrenches & Wrench Sets.....	6-9	Drill Bits & Accessories	133-137
Jumbo Combination Wrenches & Wrench Sets	10-11	Torsion Impact Bit Sets	138
Flare Nut Wrenches	12	Impact Bits & Adapters.....	139-144
Spline Drive Wrenches.....	12	AIR POWER.....	145-171
Ratcheting Combination Wrenches & Wrench Sets	13	Air Tools.....	145-149
Flex-Head Ratcheting Combination Wrenches..	14	Spray Guns	150-154
Reversible Ratcheting Combination Wrenches..	15	Air Hoses & Accessories	155-161
Box-end Wrenches.....	16	Air Pumps & Gauges.....	162-163
Wrench Accessories.....	16	Chucks, Plugs & Couplers	164-167
Pipe Wrenches.....	17	Spray Gun Rebuild Kits.....	170
Key Sets.....	18-21	Air Tool Accessories	171
Torque Tools.....	22-23	WELDING, BRAZING & SOLDERING	172-179
Socket Sets.....	24-25	Welding Helmets	172-174
Screwdrivers & Screwdriver Sets.....	26-33	Welders & Plasma Cutters	175
Pliers & Plier Sets	34-36	Welding Safety & Accessories.....	176
Cutting Tools.....	36-38	Welding Tools.....	177-179
Hammers & Mallets.....	39-40	AUTOMOTIVE SPECIALTY TOOLS	180-184
Pry Bars	41-42	LUBRICATION	185
Electrical Tools	43-48	IMPULSE.....	186-198
Riveters, Multi-tools & Knives	49	Counter Displays.....	186-194
Inspection & Retrieval Tools.....	50-54	Soldier Packs	195-198
Measuring & Layout Tools.....	54-56	SHOP EQUIPMENT	199-226
Pick & Hook Sets	57-58	Auto Body Repair.....	199-205
Pipe & Tubing Tools.....	59-61	Hardware Kits.....	206-216
Scrapers & Blades	62-67	Magnets	217-219
Utility Knives.....	68	Lawn & Garden Tools.....	220
Vises & C-Clamps	69-72	Moving Supplies.....	221
RATCHETS, SOCKETS & DRIVE TOOLS.....	73-115	Heat Guns	221
Multi-Drive Sets.....	73-77	Tool Storage	221-224
1/4 in. Drive Tools.....	78-82	Tire & Wheel Tools	225-226
3/8 in. Drive Tools.....	83-94	Work Benches	226
1/2 in. Drive Tools.....	94-104	INDEX.....	227-235
3/4 & 1 in. Drive Tools	105		
Ratchet Rebuild Kits and Breaker Bar Replacement Heads	106		
Bit Sockets & Bit Socket Sets	107-115		
IMPACT SOCKETS & DRIVE TOOLS.....	116-129		
1/4 in. Drive Impact Accessories, Sockets & Socket Sets.....	116		
3/8 in. Drive Impact Accessories, Sockets & Socket Sets.....	117-118		
1/2 in. Drive Impact Accessories, Sockets & Socket Sets.....	119-122		
3/4 in. Drive Impact Accessories, Sockets & Socket Sets.....	123-124		
1 in. Drive Impact Accessories, Sockets & Socket Sets.....	125-126		
Impact Bit Sockets Sets	127		
Impact Multi-Drive Sets	128-129		

Adjustable Wrenches

- Precision worm gear and slide jaws for smooth adjustments and precise fit
- Corrosion-resistant satin chrome plated finish and drop forged, heat-treated carbon steel construction



Part #	Length (in.)	Jaw Capacity (in.)	UPC	Master	Inner
12141	4	9/16	8-02090-12141-8	120	6
12142	6	7/8	8-02090-12142-5	120	6
12143	8	1	8-02090-12143-2	60	6
12144	10	1-3/16	8-02090-12144-9	60	6
12145	12	1-7/16	8-02090-12145-6	36	6
215	15	1-3/4	8-02090-00215-1	16	4
218	18	2-1/4	8-02090-00218-2	12	2
224	24	2-1/2	8-02090-00224-3	4	1

Auto Wrenches

- Large capacity, smooth jaw, non-marring wrench
- Constructed from forged steel with an I-beam handle and satin finish
- Commonly used in applications such as hydraulic hose fittings, chrome accessories, or other surfaces where little or no surface damage is desired



Part #	Length (in.)	Jaw Capacity (in.)	UPC	Master	Inner
21319	9	1-3/4	8-02090-21319-9	24	1
21321	11	3	8-02090-21321-2	24	1
21325	15	3-1/2	8-02090-21325-0	12	1

Chain Wrenches

- Double serrated jaw allows rapid, ratcheting, bi-directional action
- One piece forged carbon steel handle and jaw
- I-beam handle design



Part #	Handle Length (in.)	Min. Pipe Capacity (in.)	Max. Pipe Capacity (in.)	Chain Length (in.)	UPC	Master	Inner
21370	12	2	4	17	8-02090-21370-0	20	5
21372	24	2	6-1/2	21.65	8-02090-21372-4	10	1

Adjustable Construction Wrenches



- Laser etched scales, both fractional and metric, on opposite sides of the head
- Continuous tapered handle for use with aligning bolt and rivet holes

Part #	Size (in.)	Jaw Capacity (in.)	Overall Length (in.)	UPC	Master	Inner
223 3-pc	8, 10 & 12	-	-	8-02090-00223-6	8	1
209	8	1-1/8	10	8-02090-00209-0	24	6
211	10	1-5/16	12	8-02090-00211-3	18	6
216	12	1-1/2	16	8-02090-00216-8	16	4

Strap Wrenches

- Lightweight aluminum I-beam handle
- Strong, woven polypropylene strap grips tightly without scratching or damaging surfaces
- Use on plastic or metal pipes & fittings, filters, shafts, and irregular shapes too
- Longer straps for greater capacity
- Works in the tightest quarters

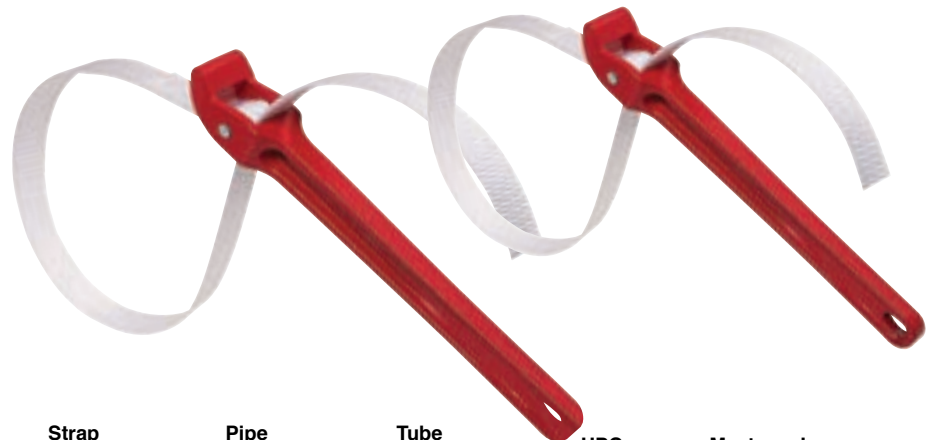

Part #	Handle Length (in.)	Strap Width (in.)	Strap Length (in.)	Pipe Capacity (in.)	Tube Capacity (in.)	UPC	Master	Inner
21315	11-13/16	1.05	34	2	9	8-02090-21315-1	25	5
21316	18	1.75	32-3/4	5	8	8-02090-21316-8	20	1

10 pc. 3/8 in. Drive Crowfoot Wrench Sets

- For use in confined areas or applications where challenging angles are present
- Mirror polished and chrome plated to resist rust
- Constructed from hardened and forged steel



Part #	Sizes	UPC	Master	Inner
17294 SAE	3/8, 7/16, 1/2, 9/16, 5/8, 11/16, 3/4, 13/16, 7/8, and 1"	8-02090-17294-6	36	6
17295 METRIC	10, 11, 12, 13, 14, 15, 16, 17, 18 & 19mm	8-02090-17295-3	36	6

10 pc. 3/8 in. Drive Flare Nut Crowfoot Wrench Sets

- For use in confined areas or applications where challenging angles are present
- Stamped sizes in each wrench for quick identification
- Mirror polished and chrome plated to resist rust
- Constructed from hardened and forged steel
- Includes aluminum storage rail



Part #	Sizes	UPC	Master	Inner
17296 SAE	3/8, 7/16, 1/2, 9/16, 5/8, 11/16, 3/4, 13/16, 7/8, and 1"	8-02090-17296-0	36	6
17297 METRIC	10, 11, 12, 13, 14, 15, 16, 17, 18 & 19mm	8-02090-17297-7	36	6

14 pc. 1/2 in. Drive Jumbo Crowfoot Wrench Sets

- For use in confined areas or applications where challenging angles are present
- Stamped sizes in each wrench for quick identification
- Corrosion resistant black finish
- Constructed from hardened and forged steel
- Includes storage case



Part #	Sizes	UPC	Master	Inner
17298 SAE	1-1/16, 1-1/8, 1-3/16, 1/1/4, 1-5/16, 1-3/8, 1-7/16, 1-1/2, 1-5/8, 1-11/16, 1-3/4, 1-13/16, 1-7/8 & 2"	8-02090-17298-4	2	1
17299 METRIC	27, 29, 30, 32, 33, 35, 36, 38, 41, 42, 45, 46, 48 & 50mm	8-02090-17299-1	2	1

5 pc. 12 pt. Combination Wrench Sets

- Set contains 5 combination wrenches
- Drop forged steel constructed
- Reuseable storage pouch included



Part #	Sizes	UPC	Master	Inner
17384 SAE	3/8, 7/16, 1/2, 9/16, and 5/8 inch	8-02090-17384-4	48	6
17385 METRIC	10, 12, 13, 14 and 15 mm	8-02090-17385-1	48	6

9 pc. 12 pt. Combination Wrench Sets

- Set contains 9 combination wrenches
- Mirror polish chrome plated with chrome vanadium steel construction for strength and durability
- Reuseable storage/carry rack included



Part #	Sizes	UPC	Master	Inner
17394 SAE	5/16, 3/8, 7/16, 1/2, 9/16, 5/8, 11/16, 3/4 and 7/8 inch	8-02090-17394-3	20	5
17395 METRIC	10, 11, 12, 13, 14, 15, 16, 17 and 18 mm	8-02090-17395-0	20	5

22 pc. 12 pt. Raised Panel SAE and Metric Combination Wrench Set **17322**

- Set contains 22 raised panel combination wrenches
- Including (1) each of the following SAE sizes: 1/4, 5/16, 3/8, 7/16, 1/2, 9/16, 5/8, 11/16, 3/4, 13/16, and 7/8 inch
- Including (1) of each Metric size: 8, 9, 10, 11, 12, 13, 14, 15, 16, 17 and 18 mm
- Constructed from drop forged, chrome vanadium steel for added strength and durability
- Wrenches feature a polished chrome finish
- Reuseable storage rack included



UPC	Master	Inner
8-02090-17322-6	10	1

11 pc. 12 pt. Raised Panel Combination Wrench Sets

- Constructed from drop forged, chrome vanadium steel for added strength and durability
- Reuseable storage rack included

Part #	Sizes	UPC	Master	Inner
17327 SAE	1/4, 5/16, 3/8, 7/16, 1/2, 9/16, 5/8, 11/16, 3/4, 13/16, and 7/8 inch	8-02090-17327-1	12	6
17328 METRIC	8, 9, 10, 11, 12, 13, 14, 15, 16, 17 and 18 mm	8-02090-17328-8	12	6



12 pt. Raised Panel Combination Wrench Set

- Constructed from drop forged, chrome vanadium steel for added strength and durability
- Reuseable storage pouch included

Part #	Sizes	UPC	Master	Inner
17329 14-pc SAE	3/8, 7/16, 1/2, 9/16, 5/8, 11/16, 3/4, 13/16, 7/8, 15/16, 1, 1-1/16, 1-1/8, 1-1/4 inch	8-02090-17329-5	4	1
17330 16-pc METRIC	10, 11, 12, 13, 14, 15, 16, 17, 18, 19, 21, 22, 24, 25, 30, 32 mm	8-02090-17330-1	4	1



7 pc. 12 pt. Metric Stubby Combination Wrench Sets

- Set contains 7 stubby combination wrenches
- Stubby design allows for use in confined areas
- Reuseable storage rack included

Part #	Sizes	UPC	Master	Inner
17373 SAE	3/8, 7/16, 1/2, 9/16, 5/8, 11/16, and 3/4 inch	8-02090-17373-8	24	6
17374 METRIC	10, 11, 12, 13, 14, 15, and 18 mm	8-02090-17374-5	24	6



22 pc. 12 pt. Fully Polished SAE and Metric Combination Wrench Set 17398

- Set contains 22 combination wrenches
- Including (1) each of the following SAE sizes: 1/4, 5/16, 3/8, 7/16, 1/2, 9/16, 5/8, 11/16, 3/4, 13/16, and 7/8 inch
- Also Including (1) each of following Metric sizes 9, 10, 11, 12, 13, 14, 15, 16, 17, 18 and 19 mm
- Mirror polish chrome plated with chrome vanadium steel construction for strength and durability
- Comes with a bonus reusable storage/carry rack



UPC	Master	Inner
8-02090-17398-1	8	2

18 pc. 12 pt. Fully Polished SAE and Metric Extra Long Combination Wrench Set 17396

- Set contains 18 extra-long combination wrenches
- SAE sizes included are (1) each: 1/4, 5/16, 3/8, 7/16, 1/2, 9/16, 5/8, 11/16, 3/4 inch
- Metric sizes included are (1) each: 6, 8, 10, 11, 13, 14, 15, 17, 18 mm
- Mirror polish chrome plated with chrome vanadium steel construction for strength and durability
- Reuseable storage/carry rack included



UPC	Master	Inner
8-02090-17396-7	6	1

Mirror Polish 12 pt. Combination Wrenches

- Slim design with 15 degree offset box-end that allows for increased utility
- Mirror polish chrome plated finish with chrome vanadium steel construction for strength and durability
- Sizes are stamped for easy identification



Part #	Size (in.)	UPC	Master	Inner
60208	1/4	8-02090-60208-5	72	12
60210	5/16	8-02090-60210-8	72	12
60212	3/8	8-02090-60212-2	72	12
60214	7/16	8-02090-60214-6	72	12
60216	1/2	8-02090-60216-0	72	12
60218	9/16	8-02090-60218-4	72	12
60220	5/8	8-02090-60220-7	72	12
60222	11/16	8-02090-60222-1	72	12
60224	3/4	8-02090-60224-5	72	12
60226	13/16	8-02090-60226-9	72	12
60228	7/8	8-02090-60228-3	72	12
60230	15/16	8-02090-60230-6	72	12
60232	1	8-02090-60232-0	36	6
60234	1-1/16	8-02090-60234-4	36	6
60236	1-1/8	8-02090-60236-8	36	6
60238	1-3/16	8-02090-60238-2	36	6
60240	1-1/4	8-02090-60240-5	36	6

Part #	Size (mm)	UPC	Master	Inner
60006	6	8-02090-60006-7	72	12
60007	7	8-02090-60007-4	72	12
60008	8	8-02090-60008-1	72	12
60009	9	8-02090-60009-8	72	12
60010	10	8-02090-60010-4	72	12
60011	11	8-02090-60011-1	72	12
60012	12	8-02090-60012-8	72	12
60013	13	8-02090-60013-5	72	12
60014	14	8-02090-60014-2	72	12
60015	15	8-02090-60015-9	72	12
60016	16	8-02090-60016-6	72	12
60017	17	8-02090-60017-3	72	12
60018	18	8-02090-60018-0	72	12
60019	19	8-02090-60019-7	72	12
60020	20	8-02090-60020-3	72	12
60021	21	8-02090-60021-0	72	12
60022	22	8-02090-60022-7	72	12
60023	23	8-02090-60023-4	72	12
60024	24	8-02090-60024-1	72	12
60025	25	8-02090-60025-8	36	6
60026	26	8-02090-60026-5	36	6
60027	27	8-02090-60027-2	36	6
60028	28	8-02090-60028-9	36	6
60029	29	8-02090-60029-6	36	6
60030	30	8-02090-60030-2	36	6
60032	32	8-02090-60032-6	36	6

12 pt. Fully Polished Combination Wrench Sets

- Reusable storage/carry rack included

Part #	Sizes	UPC	Master	Inner
17311 11-pc SAE	1/4, 5/16, 3/8, 7/16, 1/2, 9/16, 5/8, 11/16, 3/4, 13/16, and 7/8 inch	8-02090-17311-0	12	6
17312 11-pc METRIC	8, 9, 10, 11, 12, 13, 14, 15, 16, 17 and 18 mm	8-02090-17312-7	12	6





10 pc. 12 pt. Jumbo SAE Combination Wrench Set **17288**

- Set contains 12 raised panel jumbo combination wrenches
- Including (1) each of the following SAE sizes: 1-5/16, 1-3/8, 1-7/16, 1-1/2, 1-5/8, 1-11/16, 1-3/4, 1-13/16, 1-7/8 and 2 inch
- Constructed from carbon steel

UPC	Master	Inner
8-02090-17288-5	2	1

10 pc. 12 pt. Metric Jumbo Combination Wrench Set **17292**

- Set contains 10 raised panel jumbo combination wrenches
- Including (1) each of the following Metric sizes: 30, 31, 32, 33, 34, 35, 36, 38, 41, 42 mm
- Constructed from carbon steel

UPC	Master	Inner
8-02090-17292-2	2	1



7 pc. 12 pt. Metric Jumbo Combination Wrench Set **17289**

- Set contains 7 raised panel jumbo combination wrenches
- Including (1) each of the following Metric sizes: 34, 36, 38, 41, 42, 46, and 50 mm
- Constructed from carbon steel

UPC	Master	Inner
8-02090-17289-2	2	1

4 pc. 12 pt. SAE Jumbo Combination Wrench Set 17291

- Set contains 4 raised panel jumbo combination wrenches
- Including (1) each of the following SAE sizes: 2-1/8, 2-1/4, 2-3/8, 2-1/2 inch
- Constructed from carbon steel

UPC	Master	Inner
8-02090-17291-5	2	1



6 pc. 12 pt. SAE Jumbo Combination Wrench Set 17290

- Set contains 6 raised panel jumbo combination wrenches
- Including (1) each of the following SAE sizes: 1-3/8, 1-1/2, 1-5/8, 1-3/4, 1-7/8 and 2 inch
- Constructed from carbon steel

UPC	Master	Inner
8-02090-17290-8	2	1



Jumbo Combination Wrenches

- Raised panel design constructed of carbon steel for strength and durability



Part #	Size	Length (in.)	Weight (lbs)	UPC	Master	Inner	Part #	Size	Length (in.)	Weight (lbs)	UPC	Master	Inner
60002	1-5/16	17	1.78	8-02090-60002-9	20	5	60130	30 mm	15-1/16	1.32	8-02090-60130-9	1	1
60040	1-3/8	17-1/2	2.09	8-02090-60040-1	10	2	60131	31 mm	16-1/4	1.56	8-02090-60131-6	1	1
60003	1-7/16	18-3/8	2.38	8-02090-60003-6	20	5	60132	32 mm	16-1/4	1.56	8-02090-60132-3	1	1
60041	1-1/2	18-1/2	2.51	8-02090-60041-8	10	2	60133	33 mm	17	1.78	8-02090-60133-0	1	1
60042	1-5/8	19-7/8	3.08	8-02090-60042-5	10	2	60109	34 mm	17	1.78	8-02090-60109-5	10	2
60066	1-11/16	19-7/8	3.15	8-02090-60066-1	2	1	60135	35 mm	7-1/2	2.09	8-02090-60135-4	1	1
60043	1-3/4	21-1/4	3.74	8-02090-60043-2	10	2	60111	36 mm	18-3/8	2.38	8-02090-60111-8	10	2
60068	1-13/16	21-1/4	3.96	8-02090-60068-5	2	1	60112	38 mm	18-1/2	2.51	8-02090-60112-5	10	2
60044	1-7/8	22-7/16	4.60	8-02090-60044-9	4	2	60113	41 mm	19-7/8	2.76	8-02090-60113-2	10	2
60045	2	23-11/16	5.19	8-02090-60045-6	4	2	60114	42 mm	19-7/8	3.17	8-02090-60114-9	10	2
60046	2-1/8	24-1/8	5.39	8-02090-60046-3	6	2	60115	46 mm	21-1/4	3.74	8-02090-60115-6	10	2
60047	2-1/4	25	6.27	8-02090-60047-0	6	2	60117	50 mm	23-11/16	5.19	8-02090-60117-0	4	2
60048	2-3/8	26-3/16	6.71	8-02090-60048-7	6	2							
60049	2-1/2	26-11/16	8.14	8-02090-60049-4	6	2							

Mirror Polished Flare Nut Wrenches

- Slim design with 15 degree offset box-end that allows for increased utility
- Mirror polish chrome plated finish with chrome vanadium steel construction for strength and durability
- Sizes are stamped for easy identification

Part #	Sizes	UPC	Master	Inner
17388 3-pc SAE	3/8 x 7/16, 1/2 x 9/16 and 5/8 x 11/16 inch	8-02090-17388-2	30	5
17389 3-pc METRIC	10 x 12, 13 x 14 and 15 x 17 mm	8-02090-17389-9	30	5



Part #	Size	UPC	Master	Inner
60403	1/2 in. x 9/16 in.	8-02090-60403-4	72	12
60402	3/8 in. x 7/16 in.	8-02090-60402-7	72	12
60404	5/8 in. x 11/16 in.	8-02090-60404-1	72	12
60405	3/4 in. x 7/8 in.	8-02090-60405-8	72	12

Part #	Size	UPC	Master	Inner
60409	9 x 11 mm	8-02090-60409-6	72	12
60410	10 x 12mm	8-02090-60410-2	72	12
60413	13 mm x 14 mm	8-02090-60413-3	72	12
60415	15 mm x 17mm	8-02090-60415-7	72	12
60416	16 x 18 mm	8-02090-60416-4	72	12
60419	19 x 21 mm	8-02090-60419-5	72	12



Spline Drive Combination Wrenches

- Spline drive box-end design allows for use with 6 and 12 point, star, and square
- Mirror polish chrome plated finish with chrome vanadium steel construction for strength and durability
- Sizes are stamped for easy identification



Part #	Size	UPC	Master	Inner
81356	5/16 in.	8-02090-81356-6	72	12
81357	3/8 in.	8-02090-81357-3	72	12
81358	7/16 in.	8-02090-81358-0	72	12
81359	1/2 in.	8-02090-81359-7	72	12
81360	9/16 in.	8-02090-81360-3	72	12
81361	5/8 in.	8-02090-81361-0	72	12
81362	11/16 in.	8-02090-81362-7	72	12
81359	1/2 in.	8-02090-81359-7	72	12
81360	9/16 in.	8-02090-81360-3	72	12
81361	5/8 in.	8-02090-81361-0	72	12
81362	11/16 in.	8-02090-81362-7	72	12

Part #	Size	UPC	Master	Inner
81363	8 mm	8-02090-81363-4	72	12
81364	10 mm	8-02090-81364-1	72	12
81365	11 mm	8-02090-81365-8	72	12
81366	13 mm	8-02090-81366-5	72	12
81367	14 mm	8-02090-81367-2	72	12
81368	15 mm	8-02090-81368-9	72	12
81369	17 mm	8-02090-81369-6	72	12

12 pt. Ratcheting Combination Wrenches

- 72-tooth box-end ratchet design allows fast action combined with the versatility of an open end wrench performance
- Features a less than 5 degree sweep for use in confined areas
- Constructed from chrome vanadium steel with mirror finish

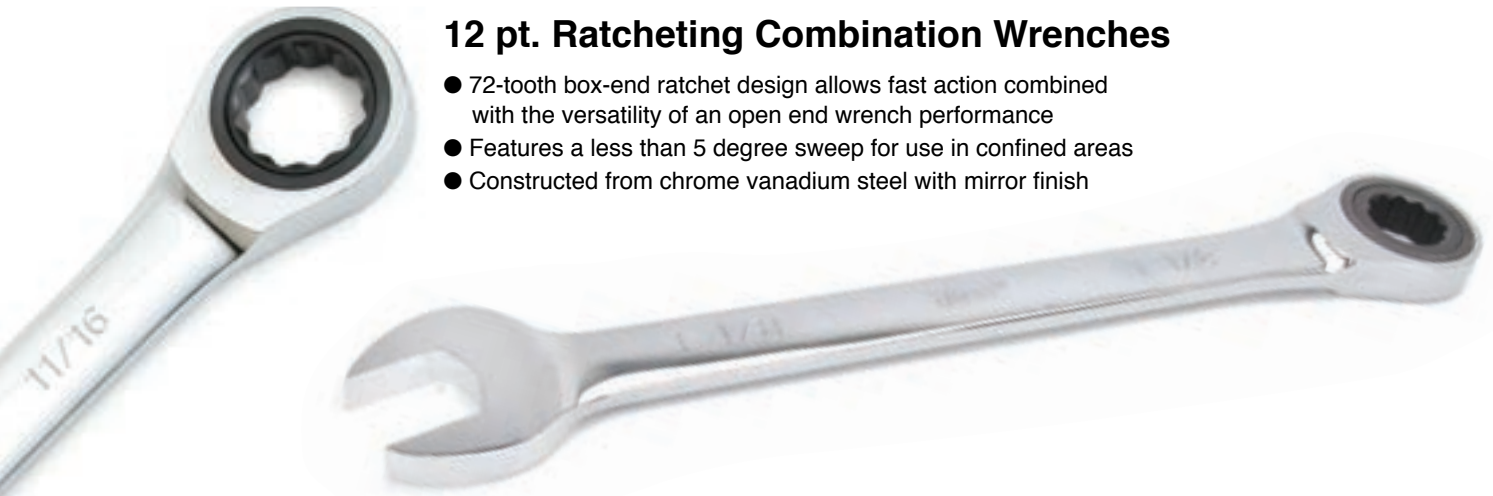

SAE SIZES

Part #	Size (in.)	UPC	Master	Inner
12601	1/4	8-02090-12601-7	100	10
12602	5/16	8-02090-12602-4	100	10
12603	3/8	8-02090-12603-1	100	10
12604	7/16	8-02090-12604-8	100	10
12605	1/2	8-02090-12605-5	100	10
12606	9/16	8-02090-12606-2	100	10
12607	5/8	8-02090-12607-9	100	10
12608	11/16	8-02090-12608-6	100	10
12609	3/4	8-02090-12609-3	100	10
12610	13/16	8-02090-12610-9	50	10
12611	7/8	8-02090-12611-6	50	10
12612	15/16	8-02090-12612-3	50	10
12613	1	8-02090-12613-0	50	10
12614	1-1/16	8-02090-12614-7	20	10
12615	1-1/8	8-02090-12615-4	20	10
12616	1-1/4	8-02090-12616-1	20	10

METRIC SIZES

Part #	Size (mm.)	UPC	Master	Inner
12506	6	8-02090-12506-5	100	10
12507	7	8-02090-12507-2	100	10
12508	8	8-02090-12508-9	100	10
12509	9	8-02090-12509-6	300	25
12510	10	8-02090-12510-2	100	10
12511	11	8-02090-12511-9	100	10
12512	12	8-02090-12512-6	100	10
12513	13	8-02090-12513-3	100	10
12514	14	8-02090-12514-0	100	10
12515	15	8-02090-12515-7	100	10
12516	16	8-02090-12516-4	100	10
12517	17	8-02090-12517-1	100	10
12518	18	8-02090-12518-8	100	10
12519	19	8-02090-12519-5	100	10
12520	20	8-02090-12520-1	50	10
12521	21	8-02090-12521-8	50	10
12522	22	8-02090-12522-5	50	10
12524	23	8-02090-12524-9	50	10
12525	24	8-02090-12525-6	50	10
12526	27	8-02090-12526-3	30	10
12527	30	8-02090-12527-0	20	10
12528	32	8-02090-12528-7	20	10
12529	34	8-02090-12529-4	15	5

SETS

Part #	Sizes	UPC	Master	Inner
17350 7-pc SAE	5/16, 3/8, 7/16, 1/2, 9/16, 5/8 & 3/4 in.	8-02090-17350-9	20	5
17351 7-pc MM	8, 10, 12, 13, 15, 16 & 18 mm	8-02090-17351-6	20	5
17362 5-pc SAE	3/8, 7/16, 1/2, 9/16 & 5/8 in.	8-02090-17362-2	24	6
17363 5-pc MM	10, 12, 13, 14 & 15 mm	8-02090-17363-9	24	6
17354 13-pc SAE	1/4, 5/16, 3/8, 7/16, 1/2, 9/16, 5/8, 3/4, 13/16, 7/8, 15/16 & 1 in.	8-02090-17354-7	6	1
17355 12-pc MM	8, 9, 10, 11, 12, 13, 14, 15, 16, 17, 18 & 19 mm	8-02090-17355-4	6	



12 pt. Flex-Head Ratcheting Combination Wrenches

- 72-tooth box-end ratchet design allows fast action combined with the versatility of an open end wrench performance
- The 90 degree flexible-head allows for maximum utility
- Features a less than 5 degree sweep for use in confined areas
- Constructed from chrome vanadium steel with mirror finish

SAE SIZES

Part #	Size (in.)	UPC	Master	Inner
12901	1/4	8-02090-12901-8	100	10
12902	5/16	8-02090-12902-5	50	10
12903	3/8	8-02090-12903-2	100	10
12904	7/16	8-02090-12904-9	100	10
12905	1/2	8-02090-12905-6	100	10
12906	9/16	8-02090-12906-3	100	10
12907	5/8	8-02090-12907-0	100	10
12908	11/16	8-02090-12908-7	50	10
12909	3/4	8-02090-12909-4	100	10
12910	13/16	8-02090-12910-0	50	10
12911	7/8	8-02090-12911-7	50	10
12912	15/16	8-02090-12912-4	35	10
12914	1	8-02090-12914-8	25	5

METRIC SIZES

Part #	Size (mm.)	UPC	Master	Inner
12808	8	8-02090-12808-0	100	10
12809	9	8-02090-12809-7	100	10
12810	10	8-02090-12810-3	100	10
12811	11	8-02090-12811-0	50	10
12812	12	8-02090-12812-7	100	10
12813	13	8-02090-12813-4	100	10
12814	14	8-02090-12814-1	100	10
12815	15	8-02090-12815-8	100	10
12816	16	8-02090-12816-5	100	10
12817	17	8-02090-12817-2	100	10
12818	18	8-02090-12818-9	100	10
12819	19	8-02090-12819-6	50	10



SETS

Part #	Sizes	UPC	Master	Inner
17366 13-pc SAE	1/4, 5/16, 3/8, 7/16, 1/2, 9/16, 5/8, 11/16, 3/4, 13/16, 7/8, 15/16 & 1 inch	8-02090-17366-0	6	
17367 12-pc MM	8, 9, 10, 11, 12, 13, 14, 15, 16, 17, 18 & 19 mm	8-02090-17367-7	6	
17360 7-pc SAE	5/16, 3/8, 7/16, 1/2, 9/16, 5/8 & 3/4 inch	8-02090-17360-8	12	6

12 pt. Reversible Ratcheting Combination Wrenches



- 72-tooth box-end ratchet design allows fast action combined with the versatility of an open end wrench performance
- Directional switch is designed to be non-obtrusive which reduces unintentional directional changes
- Features a less than 5 degree sweep for use in confined areas
- Constructed from chrome vanadium steel with mirror finish



SAE SIZES

Part #	Size (in.)	UPC	Master	Inner
14601	1/4	8-02090-14601-5	30	10
14602	5/16	8-02090-14602-2	50	10
14603	3/8	8-02090-14603-9	50	10
14604	7/8	8-02090-14604-6	100	10
14605	1/2	8-02090-14605-3	100	10
14606	9/16	8-02090-14606-0	50	10
14607	5/8	8-02090-14607-7	100	10
14608	11/16	8-02090-14608-4	50	10
14609	3/4	8-02090-14609-1	50	10
14610	13/16	8-02090-14610-7	25	5
14611	7/8	8-02090-14611-4	50	5
14612	15/16	8-02090-14612-1	25	5
14613	1	8-02090-14613-8	25	5

METRIC SIZES

Part #	Size (mm.)	UPC	Master	Inner
14508	8	8-02090-14508-7	50	10
14509	9	8-02090-14509-4	50	10
14510	10	8-02090-14510-0	50	10
14511	11	8-02090-14511-7	50	10
14512	12	8-02090-14512-4	50	10
14513	13	8-02090-14513-1	50	10
14514	14	8-02090-14514-8	50	10
14515	15	8-02090-14515-5	50	10
14516	16	8-02090-14516-2	50	10
14517	17	8-02090-14517-9	50	10
14518	18	8-02090-14518-6	50	10
14519	19	8-02090-14519-3	50	10



SETS

Part #	Sizes	UPC	Master	Inner
17364 13-pc SAE	1/4, 5/16, 3/8, 7/16, 1/2, 9/16, 5/8, 11/16, 3/4, 13/16, 7/8, 15/16 & 1 in.	8-02090-17364-6	6	1
17365 12-pc MM	8, 9, 10, 11, 12, 13, 14, 15, 16, 17, 18, and 19 mm	8-02090-17365-3	6	

12 pt. Double Box-End Ratcheting Wrenches

- 72-tooth box-end ratchet design allows fast action
- Features a less than 5 degree sweep for use in confined areas
- Constructed from chrome vanadium steel with mirror finish



SAE SIZES

Part #	Size (in.)	UPC	Master	Inner
13526	5/16 in. x 3/8 in.	8-02090-13526-2	100	10
13527	7/16 in. x 1/2 in.	8-02090-13527-9	100	10
13528	9/16 in. x 5/8 in.	8-02090-13528-6	100	10
13529	11/16 in. x 3/4 in.	8-02090-13529-3	100	10

METRIC SIZES

Part #	Size (mm.)	UPC	Master	Inner
13520	8 x 9 mm	8-02090-13520-0	100	10
13521	10 x 11 mm	8-02090-13521-7	100	10
13522	12 x 13 mm	8-02090-13522-4	100	10
13523	14 x 15 mm	8-02090-13523-1	100	10
13524	16 x 18 mm	8-02090-13524-8	100	10
13525	17 x 19 mm	8-02090-13525-5	100	10

4 pc. Socket and Bit Driver Conversion Kit 12624

- Converts box end ratcheting wrenches into socket & bit drivers
- For use with 10, 13, and 19mm wrenches
- Features quick release function
- Chrome vanadium steel construction



UPC	Master	Inner
8-02090-12624-6	100	10

Aluminum Straight Pipe Wrenches

- Lightweight aluminum constructed frame with precision milled, drop forged steel jaws and I-beam handle design

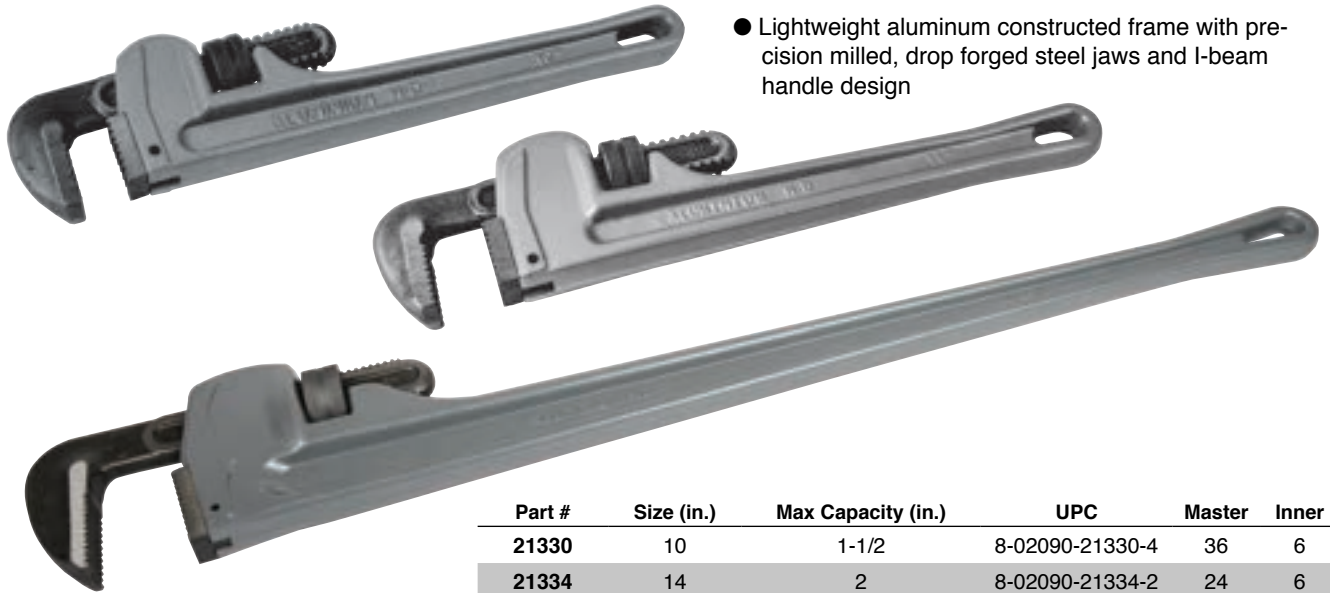

Part #	Size (in.)	Max Capacity (in.)	UPC	Master	Inner
21330	10	1-1/2	8-02090-21330-4	36	6
21334	14	2	8-02090-21334-2	24	6
21338	18	2-1/2	8-02090-21338-0	12	2
21344	24	3	8-02090-21344-1	6	2
21346	36	5	8-02090-21346-5	4	1
21348	48	6	8-02090-21348-9	2	1

Heavy-Duty Straight Pipe Wrenches

- Durable enamel finish with precision milled, drop forged steel jaws and I-beam handle design
- Heavy-duty ductile iron housing

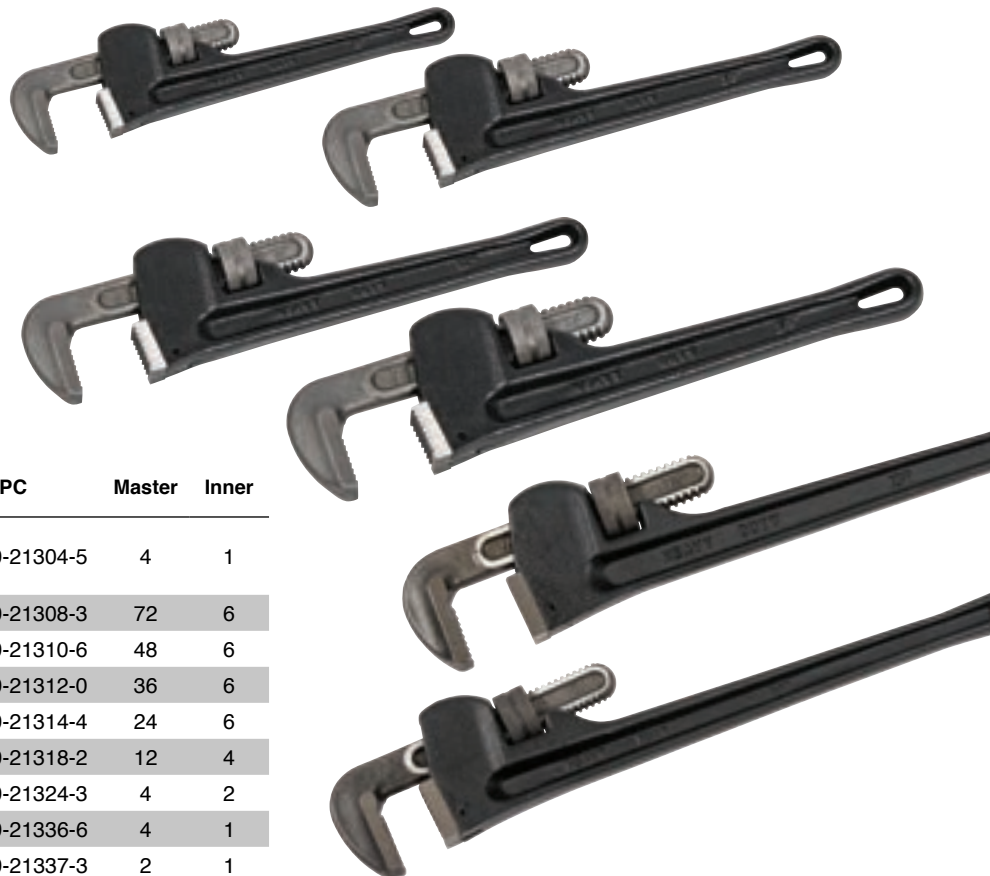

Part #	Size (in.)	Max Capacity (in.)	UPC	Master	Inner
21304 4-pc Set	8, 10, 14 and 24 inch		8-02090-21304-5	4	1
21308	8	1	8-02090-21308-3	72	6
21310	10	1-1/2	8-02090-21310-6	48	6
21312	12	1-3/4	8-02090-21312-0	36	6
21314	14	2	8-02090-21314-4	24	6
21318	18	2-1/2	8-02090-21318-2	12	4
21324	24	3	8-02090-21324-3	4	2
21336	36	5	8-02090-21336-6	4	1
21337	48	6	8-02090-21337-3	2	1

Extra Long Non Slip Key Sets

- Ball end allows for up to 25 degrees angle of entry (Hex Only)
- Satin plated textured finish for better grip
- Easy to read laser etched sizes on keys
- Constructed of S2 steel
- Includes a size identified plastic organizer

Hex SAE 12713



Hex Metric 12714



TR Star 12715



XZN Triple

Square 12733



TR 5-Lobe 12734



Part #	Sizes	UPC	Master	Inner
12713 13-pc SAE	.05, 1/16, 5/64, 3/32, 7/64, 1/8, 9/64, 5/32, 3/16, 7/32, 1/4, 5/16, and 3/8 inch	8-02090-12713-7	36	6
12714 13-pc MM	1.5, 2, 2.5, 3, 4, 5, 6, 8 and 10 mm	8-02090-12714-4	36	6
12715 13-pc TR Star	TR6, TR7, TR8, TR9, TR10, TR15, TR20, TR25, TR27, TR30, TR40, TR45 and TR50	8-02090-12715-1	36	6
12733 8-pc Triple Sq.	M3, M4, M5, M6, M8, M9, M10, and M12	8-02090-12733-5	24	6
12734 10-pc TR 5-Lobe	IPR9, IPR10, IPR15, IPR20, IPR25, IPR27, IPR30, IPR40, IPR45, and IPR50	8-02090-12734-2	36	6

T-Handle Hex Key Sets

- Key overall length: 6-3/4" to 7-1/8"
- Comfort grip handles
- Includes convenient storage pouch



Part #	Sizes	UPC	Master	Inner
12768 / 8-pc SAE	3/32, 7/64, 1/8, 9/64, 5/32, 3/16, 7/32, and 1/4 inch	8-02090-12768-7	36	6
12769 / 6-pc MM	2, 2.5, 3, 4, 5 and 6 mm	8-02090-12769-4	36	6

Hex Extractor and Hex Key Sets

- For extraction of rounded, or otherwise damaged socket head cap screws
- Patented wing tip design allows key to bite and remove partially damaged fasteners
- Keys also function as a hex key and will not damage existing undamaged fasteners
- Comes with size identified plastic organizer
- Constructed of S2 steel

Part #	Sizes	UPC	Master	Inner
12756 12-pc SAE	1/16, 5/64, 3/32, 7/64, 1/8, 9/64, 5/32, 3/16, 7/32, 1/4, 5/16 and 3/8 inch	8-02090-12756-4	36	6
12757 9-pc MM	1.5, 2, 2.5, 3, 4, 5, 6, 8, and 10 mm	8-02090-12757-1	36	6

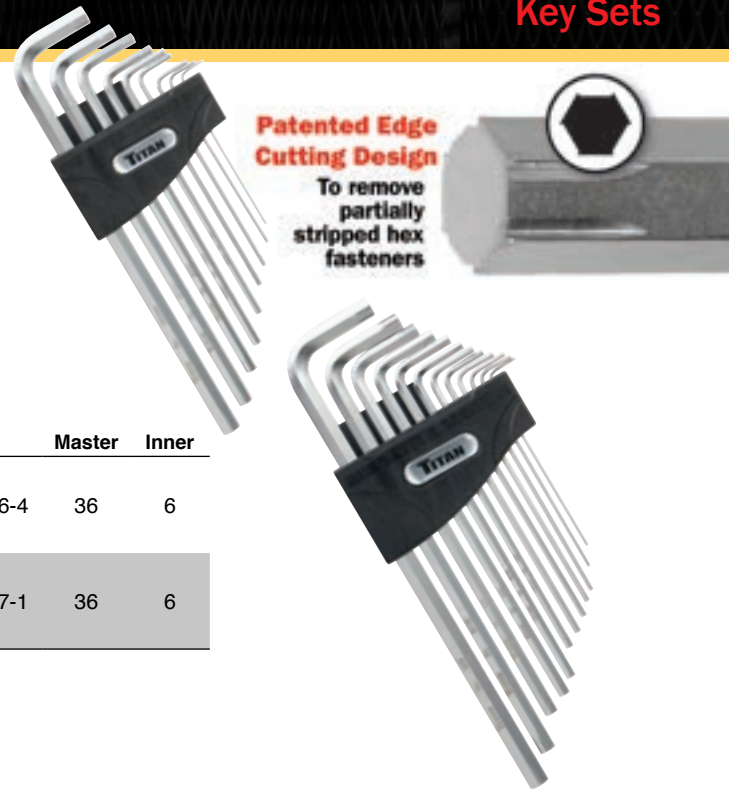

Patented Edge Cutting Design
To remove partially stripped hex fasteners

DETENT BALL END

For secure fastener removal or installation

Ball End Hex Key Sets

- Ball end contains a detent ball for secure fastener removal or installation
- Ball end allows for up to 25 degree angle of entry
- Comes with size identified plastic organizer
- Constructed of S2 Steel

Part #	Sizes	UPC	Master	Inner
12735 9-pc SAE	1/16, 5/64, 3/32, 1/8, 5/32, 3/16, 1/4, 5/16, 3/8 inch	8-02090-12735-9	36	6
12736 9-pc MM	1.5, 2, 2.5, 3, 4, 5, 6, 8, 10 mm	8-02090-12736-6	36	6

Low Profile Hex Key Sets

- Extremely low profile design allows for access in low clearance areas
- Set includes (1) each: 1.5, 2, 2.5, 3, 4, 5, 6, 8, 10 mm keys
- Comes with size identified plastic organizer
- Constructed of S2 Steel

Part #	Sizes	UPC	Master	Inner
12737	1/16, 5/64, 3/32, 1/8, 5/32, 3/16, 1/4, 5/16, 3/8 inch	8-02090-12737-3	36	6
12738	1.5, 2, 2.5, 3, 4, 5, 6, 8, 10 mm	8-02090-12738-0	36	6



Folding Key Sets

- Ball tips allow use at up to 25° angle for use in obstructed areas (Not on TR Star)
- Chrome vanadium steel construction with corrosion resistant anodized aluminum holder

Part #	Sizes	UPC	Master	Inner
12700 10-pc SAE	1/16, 5/64, 3/32, 7/64, 1/8, 9/64, 5/32, 3/16, 7/32 and 1/4 inch.	8-02090-12700-7	48	6
12705 9-pc MM	1.5, 2, 2.5, 3, 4, 5, 6 mm hex keys, #2 Phillips and 1/4" Slotted drivers	8-02090-12705-2	48	6
12710 10-pc TR Star	1TR-6, TR-7, TR-8, TR-9, TR-10, TR-15, TR-20, TR-25, TR-27 and TR-30	8-02090-12710-6	48	6



Folding Hex Key Sets

- High quality alloy steel cover with high quality alloy steel black oxide finished keys
- Overall length (closed) is 3-5/8"

Part #	Sizes	UPC	Master	Inner
12703 9-pc SAE	.050, 1/16, 5/64, 3/32, 7/64, 1/8, 9/64, 5/32, 3/16 inch	8-02090-12703-8	48	6
12708 7-pc MM	1.5, 2, 2.5, 3, 4, 5, 6 mm	8-02090-12708-3	48	6

Locking Hex Key Sets

- 3-position locking mechanism: 90, 130 & 180 degrees
- Overall closed length: 4-5/8"

Part #	Sizes	UPC	Master	Inner
12770 8-pc SAE	3/32, 7/64, 1/8, 9/64, 5/32, 3/16, 7/32 & 1/4 inch	8-02090-12770-0	48	12
12771 8-pc MM	1.5, 2, 2.5, 3, 4, 5, 6 & 8 mm	8-02090-12771-7	48	12
12772 8-pc Star	T9, T10, T15, T20, T25, T27, T30, T40	8-02090-12772-4	48	12





Long Arm Hex Key Sets

- Keys are constructed from high quality alloy steel with a black oxide finish
- Includes a conveniently marked color coordinated plastic organizer

Part #	Sizes	UPC	Master	Inner
12718 13-pc SAE	.050, 1/16, 5/64, 3/32, 7/64, 1/8, 9/64, 5/32, 3/16, 7/32, 1/4, 5/16, 3/8 inch	8-02090-12718-2	36	6
12719 9-pc MM	1.5, 2, 2.5, 3, 4, 5, 6, 8, 10 mm	8-02090-12719-9	36	6

39 pc. Star and Hex Key Set **12739**

- SAE hex key sizes include (1) each: 1/16, 5/64, 3/32, 1/8, 9/64, 7/64, 5/32, 3/16, 7/32, 1/4, 5/16, 3/8 inch; Metric hex key sizes include (1) each: 1.27, 1.5, 2, 2.5, 3, 4, 4.5, 5, 5.5, 6, 7, 8, and 10 mm; Star key sizes include (1) each: T6, T7, T8, T9, T10, T15, T20, T25, T27, T30, T40, T45, T50, and T55
- Also included are (3) color coded folding storage racks
- Keys are constructed from carbon steel with a black oxide finish



UPC	Master	Inner
8-02090-12739-7	15	5

25 pc. Hex Key Set **12712**

- SAE sizes included: 1/16, 5/64, 3/32, 7/64, 1/8, 9/64, 5/32, 3/16, 7/32, 1/4, 5/16 and 3/8 inch; Metric sizes included: 1.27, 1.5, 2, 2.5, 3, 4, 4.5, 5, 5.5, 6, 7, 8 and 10 mm
- Constructed from heat treated carbon steel with black oxide finish
- Pivot style holder release feature allows for removal of any key without interference of adjacent keys



UPC	Master	Inner
8-02090-12712-0	24	6

7 pc. SAE Short Arm Hex Key Set **12727**

- Set contains (1) each of the following common SAE sizes: 5/64, 3/32, 7/64, 1/8, 9/64, 5/32, and 3/16 inch keys
- Keys are constructed from high quality alloy steel with a black oxide finish
- Includes a conveniently marked color coordinated plastic organizer



UPC	Master	Inner
8-02090-12727-4	48	12

16 pc. SAE/Metric Hex Key Set **12726**

- SAE sizes include (1) each: 1/16, 5/64, 3/32, 1/8, 5/32, 3/16, 7/32, 1/4 inch; Metric sizes include (1) each: 1.5, 2, 2.5, 3, 4, 5, 5.5, and 6 mm
- Keys feature different finishes for easy identification: nickel plated for SAE and black finish for Metric set
- Made of Carbon Steel
- Convenient storage pouch



UPC	Master	Inner
8-02090-12726-7	96	12



Beam Type Torque Wrenches

- Works with right and left hand thread fasteners
- Minimum wear or fatigue over the lifetime of the tool, insuring better accuracy

Part No	Drive Size (in.)	Range	Accuracy	Item UPC	Master	Inner
23140	1/4	0-80 in./lbs. (0-9 Nm)	+/- 7%	8-02090-23140-7	24	6
23141	3/8	0-800 in./lbs. (0-90 Nm)	+/- 4%	8-02090-23141-4	12	6
23142	1/2	0-150 ft./lbs. (0-203 Nm)	+/- 4%	8-02090-23142-1	12	6

Reversible Micrometer Torque Wrenches

- Reversible ratchet mechanism for quicker use
- Locking handle prevents unwanted setting changes



Part No	Drive Size (in.)	Range	Item UPC	Master	Inner
23146	1/4	20-200 in/lbs	8-02090-23146-9	12	1
23147	3/8	60-960 in/lbs (5-80ft/lbs)	8-02090-23147-6	12	1
23148	1/2	120-1800 in/lbs.(10-150 ft/lbs)	8-02090-23142-1	12	6

1/2 in. Drive Reversible Micrometer Torque Wrenches

- Easy to read analog scale window for setting torque in Pound-Feet and Newton-Meters
- Push-through drive square for accurate torque on both right and left hand threads
- Chrome vanadium ratchet gear
- Fully heat-treated handle
- Non-slip contour grip
- Meets ANSI specifications
- Includes blow molded storage case



Part No	Range	Item UPC	Master	Inner
23150	20-150 Ft -Lb (27-203 Nm)	8-02090-23150-6	10	5
23151	50-250 Ft -Lb (68-339 Nm)	8-02090-23151-3	8	4

3/4 in. Drive Torque Wrench 23152

- Easy to read analog scale for setting torque in Foot-Pounds and Newton-Meters
- Torque Range: 100-600 ft/lbs
- Overall length: 43-3/4 in.



UPC	Master	Inner
8-02090-23152-0	2	1

1/2 in. Drive Digital Torque Adapter 23154



- Calibration device for torque wrenches
- Can be used for both right and left hand fasteners or can be used in either clockwise or counter clockwise applications
- Includes a calibrating block
- Converts any ratchet into a torque measuring tool
- Use to re-calibrate any type of torque wrench
- UOM: Kg-CM, Kg-M, In-lb, Ft-lb, and N-m
- Range: 30-150ft-lbs
- LED backlight

UPC	Master	Inner
8-02090-23154-4	24	1

40 pc. Socket Set 18196

- Carbon steel construction
- Includes:
- (12) 1/4" Dr. SAE sockets: 5/32, 3/16, 7/32, 1/4, 9/32, 5/16, 11/32, 3/8, 13/32, 7/16, 15/32 and 1/2"13; 1/4" Dr. Metric sockets: 4, 4.5, 5, 5.5, 6, 6.5, 7, 8, 9, 10, 11, 12 and 13mm
- (3) 3/8" Dr. SAE sockets: 7/16, 1/2 and 9/16"
- (3) 3/8" Dr. Metric sockets: 11, 12 and 13mm
- (3) 1/4" Dr. (8pt) sockets: 1/4, 5/16, 3/8"
- (1) 3/8" Dr. ratchet handle
- (1) 1/4" Dr. spinner handle
- (1) 3/8" Dr. 3" extension bar
- (1) 1/4" x 3/8" drive adapter
- (1) 3/8" Dr. spin disc
- (1) Blow molded storage case



UPC	Master	Inner
8-02090-18196-2	16	

75 pc. Socket Set 18194

- (1) Blow Molded Case
- (2) 3/8" & 1/2" Reversible Ratchet Handles
- (8) Hex Keys
- (11) Power Bits & Holder
- (1) Spinner Handle, Coupler, 3/8" Dr 3" Extension, 3/8" Spin Disc
- (1) 3/8" (F) x 1/4" (M) Adapter
- (1) 3/8" Dr. Spark Plug Socket 5/8"
- (6) 3/8" Dr. Sockets: 7/16, 15/32, 1/2, 9/16, 5/8, 11/16"
- (14) 1/4" Dr. Sockets: 5/32, 3/16, 7/32, 1/4, 9/32, 5/16, 11/32, 3/8, 13/32, 7/16, 15/32, 1/2, 17/32, 9/16" (3) 1/4" Dr Socket: 1/4, 5/16, 3/8" (4) 1/2" Dr Socket: 11/16, 3/4, 25/32, 7/8" (6) 3/8" Dr Sockets: 11, 12, 13, 14, 16, 17m (14) 1/4" Dr Socket: 4, 4.5, 5, 5.5, 6, 6.5, 7, 8, 9, 10, 11, 12, 13, 14mm



UPC	Master	Inner
8-02090-18194-8	5	1

52 pc. Socket Set 18198

- (4) 1/2" Dr. SAE sockets: 13/16, 3/4, 5/8 and 11/16"
- (1) 1/2" Dr. ratchet handle
- (3) 3/8" Dr. SAE sockets: 9/16, 1/2 and 7/16"
- (3) 3/8" Dr. Metric sockets: 11, 12 and 13mm
- (1) 3/8" Dr. Spark plug socket: 5/8", 3/8" Dr. 3" Extension bar, 3/8" Dr. Ratchet handle, 3/8" Dr. Spin disc
- (12) 1/4" Dr. SAE Sockets: 1/2, 15/32, 7/16, 13/32, 3/8, 11/32, 5/16, 9/32, 1/4, 7/32, 3/16 and 5/32"
- (13) 1/4" Dr. Metric Sockets: 13, 12, 11, 10, 9, 8, 7, 6.5, 6, 5.5, 5, 4.5, 4mm
- (3) 1/4" Dr. SAE Sockets (8pt): 3/8", 5/16", 1/4"
- (5) Screwdriver bits: 3/16" & 5/32" Slotted and #1, #2 & #3 Phillips
- (1) 1/4" x 3/8" drive adapter
- (1) 1/4" Dr. Coupler
- (1) 1/4" Dr. spinner handle
- (1) Blow molded storage case



UPC	Master	Inner
8-02090-18198-6	5	1

21 pc. Exo-Drive Socket Set 17400

- 17 low profile sockets: 3/8, 7/16, 1/2, 9/16, 5/8, 11/16, 3/4" and 10, 11, 12, 13, 14, 15, 16, 17, 18, 19mm
- Slim head ratchet handle
- 1/4" & 3/8" drive quick-release conventional adapters
- 3" EXO-Drive™ extension
- Chrome vanadium steel, fully polished and chrome plated

UPC	Master	Inner
8-02090-17400-1	10	5



21 pc. 1/4 in. Drive SAE/ Metric Socket Set 18180

- Set Includes:
- 6pt SAE Sockets: 5/32, 7/32, 1/4, 9/32, 5/16, 11/32, 3/8, 7/16, 15/32, 1/2"
- 6pt Metric Sockets: 4, 5, 6, 7, 8, 9, 10, 11, 12, & 13mm
- 5-1/2" Quick Release 1/4" Dr Ratchet
- Carbon Steel construction

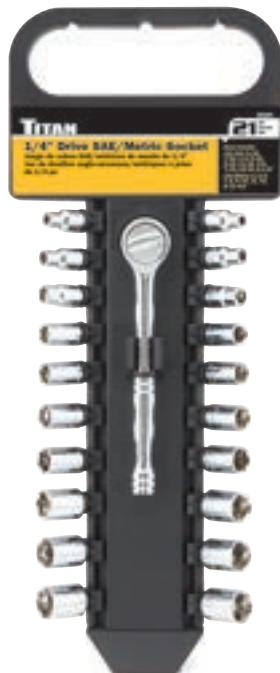

UPC	Master	Inner
8-02090-18180-1	24	6

19 pc. 3/8 in. Drive SAE/ Metric Socket Set 18181

- Set Includes:
- 6pt SAE Sockets: 3/8, 7/16, 15/32, 1/2, 9/16, 5/8, 11/16, 3/4, & 13/16"
- 6pt Metric Sockets: 9, 10, 11, 12, 13, 14, 15, 17, 19 mm
- 7-3/4" Quick Release 3/8" Dr Ratchet
- Carbon Steel Construction



UPC	Master	Inner
8-02090-18181	24	6

17 pc. 1/2 in. Drive SAE/ Metric Socket Set 18182

- Set Includes:
- 6pt SAE Sockets: 1/2" Drive Sockets 3/8, 7/16, 1/2, 9/16, 5/8, 11/16, 3/4, 13/16"
- 6pt Metric Sockets: 10, 11, 12, 13, 14, 15, 17, 19 mm
- 9-3/4" Quick Release 1/2" Dr Ratchet
- Carbon Steel Construction



UPC	Master	Inner
8-02090-18182-5	12	6

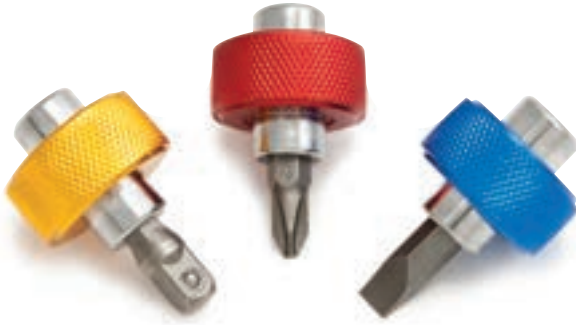

3 pc. 1/4 in. Drive Finger Grip Drivers 11218

- Size includes: (1) 1/4in slotted screwdriver bit, (1) #2 Phillips screwdriver bit, (1) 1/4in socket adapter
- Knurled for easier grip
- Interchangeable bits

UPC	Master	Inner
8-02090-11218-8	96	12

12 pc. 18 in. Extra-Long Ratcheting Screwdriver 12218

- High-torque for maximum utility: 250 in-lbs (35 kg/m)
- Bits included: (3) Phillips bits, sizes: #1, #2, and #3, (4) Slotted bits, sizes: 5/32", 3/16", 1/4", and 9/32", (2) Star bits, sizes: T15 and T20, (1) Square bit, size: SQ2
- Set also includes (1) 1-1/4 in. socket adapter
- Reversible ratcheting design
- Magnetic bit holder
- Bit storage in handle
- Bits made of S2 steel
- Overall Length: 18 in.

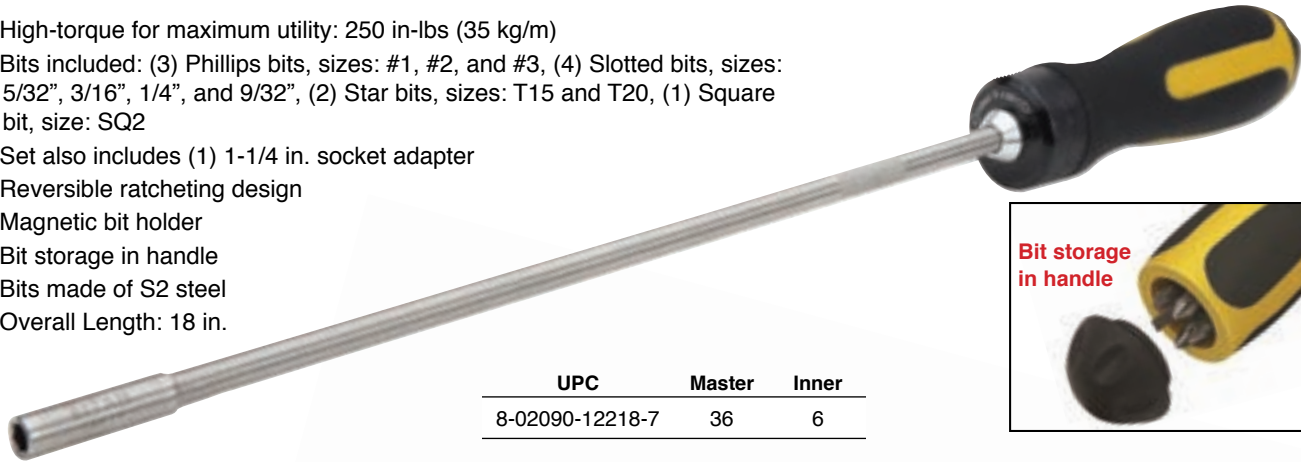

UPC	Master	Inner
8-02090-12218-7	36	6

Bit storage
in handle

10 in. High-Torque Flex-Head Ratcheting Screwdriver 12217

- Set Includes: (3) Phillips: #1, #2, and #3, (4) Slotted: 5/32, 3/16, 1/4, and 9/32 inch, (2) Star: T15 and T20, (1) Square: SQ2, (1) 1-1/4" Socket Adapter
- High Torque 250 in-lbs (3 kg/m)
- Flex-head, 20 degree angle
- Reversible ratcheting design
- Convenient bit storage in handle
- Bits made of S2 steel
- Overall Length: 10 in.



UPC	Master	Inner
8-02090-12217-0	48	6

12 in. High Torque Ratcheting Screwdriver 12220

- High Torque 250 in-lbs (35 kg/m)
- Set Includes: (3) Phillips: #1, #2, & #3, (4) Slotted: 5/32", 3/16", 1/4", & 9/32", (2) Star: T15 & T20, (1) Square: SQ2, (1) 1-1/4" Socket Adapter
- Reversible ratcheting design
- Stainless steel shaft
- Bit storage in handle
- Bits made of S2 steel
- Overall Length: 12"



UPC	Master	Inner
8-02090-12220-0	36	6

31 pc. Bit Set With Case 16068

- Set Includes the following bits:
SL: 3.5, 4.5, 5.5, 6, 8
Hex: 2, 2.5, 3, 4, 5, 6, 8
PH: #0, #1, #2, #3
PZ: #0, #1, #2, #3
SQ: #1, #2
Star: T9, 10, 15, 20, 25, 27, 30, 40
- 7-1/2 in. bit driver
- Bit storage rack



UPC	Master	Inner
8-02090-16068-4	48	12

14 pc. Torx® Bit Socket Set 16190

- Set includes: (6) 1/4 in. drive bits, sizes: T10, T15, T20, T25, T27 and T30, (1) 1/4 in. drive x 6-3/4 in. driver handle, (6) 3/8 in. drive bits, sizes: T40, T45, T47, T50, T55 and T60, (1) 1/4 in. Female to 3/8 in. Male socket adapter, (2) Bonus convenient storage rails



UPC	Master	Inner
8-02090-16190-2	32	8

1/4 in. Drive Impact Driver 16007

- Set Includes: (1) 1/4 in. Drive Impact Driver, (1) 1/4 in. Drive Socket Adapter, (1) 3 in. Bit: Phillips PH2, (4) 2 in. Bits: Slotted 3/16 in., Square SQ2, Phillips PH1 & Phillips PH2
- Chrome-moly construction for durability
- Laser etched size markings for easy identification

UPC	Master	Inner
8-02090-16007-3	48	6

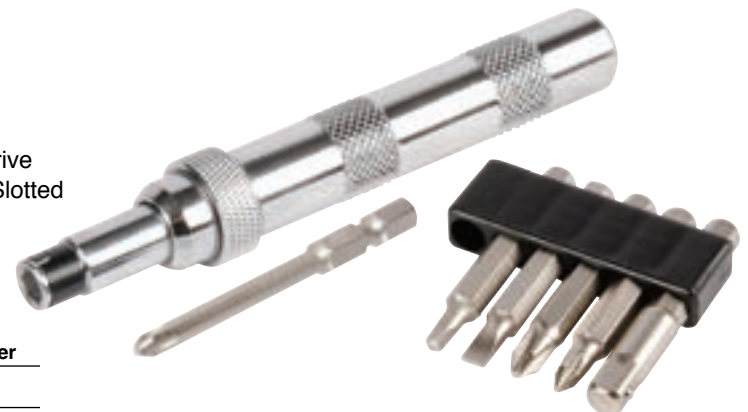

9 pc. Flexible Driver and Bit Set 12227

- Set includes following bits: (3) Slotted: 4mm, 5mm, 6mm, (3) Phillips: PH1, PH2, PH3, (2) Star: T15, T20
- Ergonomic cushioned handle
- Overall length: 11-1/4 in.
- Includes bit holder



UPC	Master	Inner
8-02090-12227-9	24	6

Fits All Phillips Screwdriver 12225

- Patented, precision ground tip design fits a variety of screw sizes
- Chrome plated S2 Alloy steel shaft has fits-all Phillips on one end and 1/4in slotted at other end
- Ergonomic TPR comfort handle for maximum grip and user comfort
- Overall Length: 8 in.



UPC	Master	Inner
8-02090-12225-5	72	12

9 pc. Tamper Resistant Torx® Bit Set 16030

- Set includes: (8) Tamper resistant, durable S2 steel Torx bits, sizes: TR8, TR10, TR15, TR20, TR25, TR27, TR30 and TR40
- (1) 1/4 inch drive adapter
- Includes bit holder



UPC	Master	Inner
8-02090-16030-1	60	10

26 pc. Ratcheting Precision Screwdriver 16092

- Set Includes: (1) 5" Ratcheting Driver, (1) 4-1/2" Extension Bar, (7) Phillips: PH000, (2) PH00, (2) PH0, PH1 and PH2, (5) Slotted: 1/16", 5/64", 3/32", 1/8" and 5/32", (5) SAE Hex: 1/16", 5/64", 3/32", 1/8" and 5/32", (5) Star: T5, T6, T7, T8 & T9, (2) Triwing: 2mm and 3mm
- For use with a wide range of projects including automotive, small engine, household & electronic applications
- Aluminum constructed 4-3/4 in. bit driver
- Comfort grip handle



UPC	Master	Inner
8-02090-16092-9	96	12

26 pc. Precision Bit and Driver Set 16028

- One-click release
- Rotatable tool tray
- Push button ejection
- Color coded ring for easy identification
- Specialized tip for smart phones
- Bits include: (4) Phillips: 000, 00, 0, 1; (2) Pentalobe: TS1, TS5; (5) Slotted: 1.0, 1.5, 2.0, 2.5, 3.0; (7) Hex: 0.7, 0.9, 1.3, 1.5, 2.0, 2.5, 3.0; (6) STAR: T4, T5, T6, T7, T8, T9; (1) Magnetic bit holder; (1) 3-1/4 in. Aluminum Bit Driver



UPC	Master	Inner
8-02090-16028-8	48	12

Precision Pocket Screwdriver

- Star bits for specialty applications
- Convenient bit storage in handle and handy pocket clip
- Anodized aluminum alloy handle is knurled for a secure grip
- Magnetic tip holds bits securely

Part #	Sizes	UPC	Master	Inner
17201	Slotted: 1/16, 5/64, 3/32, 1/8 inch	8-02090-17201-4	48	6
	Phillips: #000, #00, #0, #1			
17202	Star: T3, T4, T5, T6, T7, T8, T9, & T10	8-02090-17202-1	48	6



26 pc. Screwdriver Set 17203

- Set includes:
 - (7) Slotted: 1/4" x 1-1/2", 1/8" x 3", 5/32" x 4", 3/16" x 3", 1/4" x 6", 5/16" x 6", 5/16" x 8"
 - (5) Star: T10 x 3", T15 x 4", T20 x 4", T25 x 4", T27 x 4"
 - (9) Phillips: PH00 x 3", PH0 x 3", PH1 x 4", PH2 x 1-1/2", PH2 x 4", PH2 x 6", PH3 x 6", PH3 x 6", PH3 x 8"
 - (3) Square: S1 x 4", S2 x 4", S3 x 4"



Straight Pick & Offset Pick
● Free standing or hanging rack storage

UPC	Master	Inner
8-02090-17203-8	4	1

8 pc. Screwdriver Set 17208

- Set includes: (3) Slotted: 6" x 5/16", 4" x 1/4", 3" x 3/16" – (3) Phillips: 3" x #1, 4" x #2, 6" x #3, (2) Stubby: 1/4" Slotted, #2 Phillips
- Hex bolsters for additional torque (on larger drivers)
- Magnetic tips
- Chrome vanadium steel shafts
- Ergonomic soft grip handle for maximum comfort
- Re-usable storage tray



UPC	Master	Inner
8-02090-17208-3	12	6

10 pc. Screwdriver Set 17241

- Set includes: (2) Phillips: 3" x #1, 4" x #2 – (2) Slotted: 4" x 1/4", 6" x 5/16" – (1) Square: S2 – (2) Stubby: 1-1/2" x #2 PH, 1-1/2 x 1/4" SL – (1) 4-1/4" mini magnetic parts tray – (1) 3 lb. telescoping magnetic pick-up tool
- Chrome vanadium shafts with magnetic tips



UPC	Master	Inner
8-02090-17241-0	12	6

3 pc. Extra-Long Screwdriver Set 17212

- Extra Long design for easier access in hard-to-reach areas
- Chrome plated to resist corrosion
- Sizes includes: PH#2, PH#3, & SL 5/16"
- Shaft length: 17-5/8"
- Overall length: 22-1/2"



UPC	Master	Inner
8-02090-17212-0	12	6

Quarter Turn Fastener Tool 12240

- For quick and easy removal and installation of 1/4 in. turn Z-Lock fasteners
- Wide, 1/2 in. contoured blade design allows for locking and unlocking Z-lock type 1/4 turn fasteners
- 6-3/8 in. overall length with a 2-1/16 in. shank
- Ergonomic TPR comfort handle for maximum grip and user comfort
- Used for panel retention on performance vehicles, motorcycles & aircraft



UPC	Master	Inner
8-02090-12240-8	72	12

Scratch Awl 15045

- Use for initiating holes for screws or nails, and scribing lines in automotive and household applications
- Overall Length: 7"
- 1/4" Shank



UPC	Master	Inner
8-02090-15045-6	96	24

7 pc. Tamper Resistant Torx® Screwdriver Set 17209

- T8 , T10 , T15 , T20 (Total Length: 10 inch)
- T25 , T27 , T30 (Total Length 12-3/4")
- Black Tip with Chrome Shaft



UPC	Master	Inner
8-02090-17209-0	12	6

6 pc. Security Star Driver Set 17210

- Set includes: TR10, TR15, TR20, TR25, TR27 and TR30 drivers
- Drilled tips allow use on tamper resistant security screws
- Hex bolsters allow for additional torque
- Driver size clearly identified on handle and shaft
- Ergonomic soft grip handle for maximum comfort
- Chrome vanadium shafts with magnetic tips



UPC	Master	Inner
8-02090-17210-6	12	6

3pc Square Driver Set 17213

- Sizes include S1, S2, S3
- Color coded for easy identification: S1 green, S2 red, S3 black
- Driver size clearly marked on handle
- 4" round shaft
- Ergonomic smooth, rounded end cap
- CRV Construction with TPR handle



UPC	Master	Inner
8-02090-17213-7	12	1

7 pc. Electrician Screwdriver Set 17237

- Magnetic drive tips
- Insulated blades for applications up to 1000V AC and 1500V DC
- Tested according IEC 60900:2004
- Contoured cushion grip handles
- Sizes included:
- 3" x #0, 4" x #1 and 4" x #2 Phillips;
- 3" x 1/8", 4" x 5/32", 5" x 7/32" and 6" x 1/4" Slotted

UPC	Master	Inner
8-02090-17237-3	12	6



42 pc. Screwdriver Set 17242

- Set includes: (4) Precision Picks, (6) Slotted Screwdrivers, (5) Phillips Screwdrivers, (2) Square Drive Screwdrivers, (4) Star Drive Screwdrivers, (1) Tack Puller, (1) Spinner Handle, (9) 1/4" SAE Sockets, (9) 1/4" Metric Sockets & (1) Magnetic Parts Tray
- Magnetic tips hold screws securely

UPC	Master	Inner
8-02090-17242-7	8	1



5 pc. Screwdriver Set 61105

- Sizes includes: (2) Phillips Screwdriver: 4" x #1 & 4" x #2, (3) Slotted Screwdriver: 4" x 3/16", 4 x 1/4" & 6" x 5/16"
- Oversized fluted handles for additional torque
- Durable chrome vanadium shafts with magnetic tip
- Chemical resistant handles

UPC	Master	Inner
8-02090-61105-6	24	6





Phillips Screwdrivers

- Durable chrome vanadium shafts with magnetic tip
- Chemical resistant, oversized fluted handles for additional torque

Part #	Size	UPC	Master	Inner
60960	#0 x 3 in.	8-02090-60960-2	72	12
60961	#1 x 3 in.	8-02090-60961-9	72	12
60962	#1 x 6 in.	8-02090-60962-6	72	12
60963	#2 x 4 in.	8-02090-60963-3	72	12
60964	#2 x 6 in.	8-02090-60964-0	72	12
60965	#2 x 8 in.	8-02090-60965-7	72	12
60966	#2 x 22 in.	8-02090-60966-4	72	12
60967	#2 x 2-1/2 in.	8-02090-60967-1	72	12
60968	#3 x 6 in.	8-02090-60968-8	72	12
60971	#3 x 22 in.	8-02090-60971-8	72	12
60969	#4 x 8 in.	8-02090-60969-5	72	12

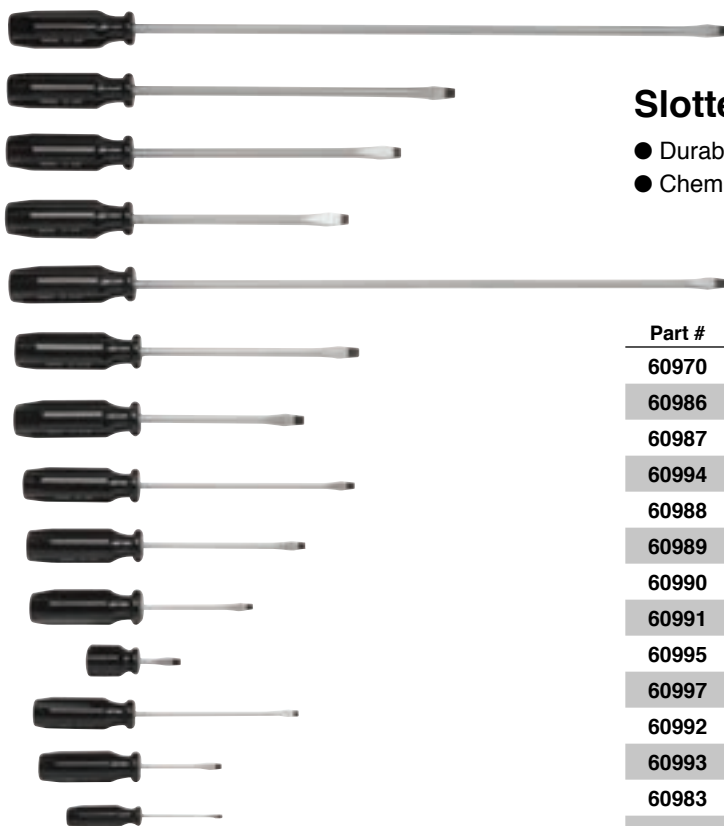

Slotted Screwdrivers

- Durable chrome vanadium shafts with magnetic tip
- Chemical resistant, oversized fluted handles for additional torque

Part #	Size	UPC	Master	Inner
60970	1/8 in. x 3 in.	8-02090-60970-1	72	12
60986	3/16 in. x 3 in.	8-02090-60986-2	72	12
60987	3/16 in. x 6 in.	8-02090-60987-9	72	12
60994	1/4 in. x 1-1/2 in.	8-02090-60994-7	72	12
60988	1/4 in. x 4 in.	8-02090-60988-6	72	12
60989	1/4 in. x 6 in.	8-02090-60989-3	72	12
60990	1/4 in. x 8 in.	8-02090-60990-9	72	12
60991	5/16 in. x 6 in.	8-02090-60991-6	72	12
60995	5/16 in. x 8 in.	8-02090-60995-4	72	12
60997	5/16 in. x 22 in.	8-02090-60997-8	72	12
60992	3/8 in. x 8 in.	8-02090-60992-3	72	12
60993	3/8 in. x 10 in.	8-02090-60993-0	72	12
60983	3/8 in. x 12 in.	8-02090-60983-1	72	12
60998	3/8 in. x 22 in.	8-02090-60998-5	72	12

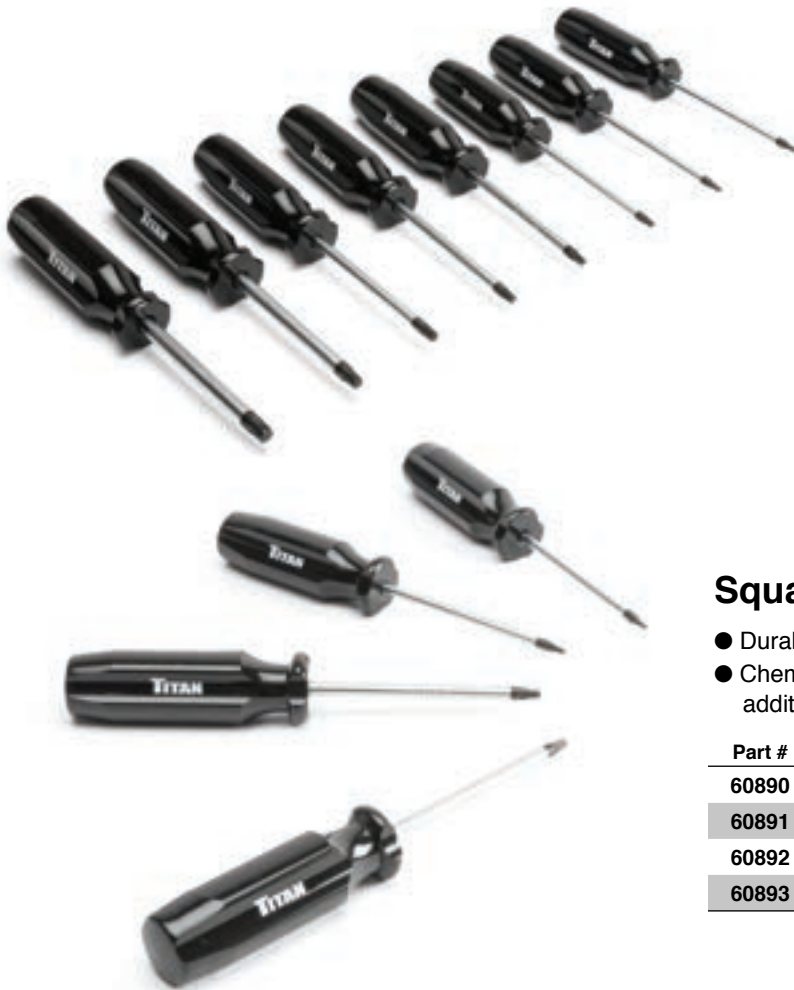

Star Drivers

- Durable chrome vanadium shafts with magnetic tip
- Chemical resistant, oversized fluted handles for additional torque

Part #	Size	UPC	Master	Inner
60810	T10	8-02090-60810-0	72	12
60815	T15	8-02090-60815-5	72	12
60820	T20	8-02090-60820-9	72	12
60825	T25	8-02090-60825-4	72	12
60827	T27	8-02090-60827-8	72	12
60830	T30	8-02090-60830-8	72	12
60840	T40	8-02090-60840-7	72	12
60847	T47	8-02090-60847-6	72	12

Square Drive Screwdrivers

- Durable chrome vanadium shafts with magnetic tip
- Chemical resistant, oversized fluted handles for additional torque

Part #	Size	UPC	Master	Inner
60890	R0 x 4 in.	8-02090-60890-2	72	12
60891	R1 x 4 in.	8-02090-60891-9	72	12
60892	R2 x 4 in.	8-02090-60892-6	72	12
60893	R3 x 4 in.	8-02090-60893-3	72	12

4 pc. 6 in. Plier Set 18404

- Oversized ergonomic grips provide extra comfort and reduced hand fatigue
- Chrome vanadium steel construction
- Includes 4 pliers: 7" Lineman, 6" Diagonal, 6" Slip-Joint and 6" Long Nose Pliers

UPC	Master	Inner
8-02090-18404-8	18	6



5 pc. Mini Plier Set 18405

- Double dipped cushion grip handles for comfort
- Drop forged high carbon steel with hardened cutting edges
- Rust resistant finish
- 5 most popular pliers: diagonal cutters, flat nose pliers, needle nose pliers, linesman pliers and end nipper

UPC	Master	Inner
8-02090-18405-5	24	6

Pliers

- Constructed from durable, long lasting, drop forged heat treated high carbon alloy steel

Part #	Size	UPC	Master	Inner
Slip Joint Pliers				
60720	6"	8-02090-60720-2	36	6
60721	8"	8-02090-60721-9	36	6
60722	10"	8-02090-60722-6	36	6
Diagonal Pliers				
60725	6"	8-02090-60725-7	36	6
60726	8"	8-02090-60726-4	36	6
Linesman Pliers				
60727	8"	8-02090-60727-1	36	6
Long Nose Pliers				
60731	6"	8-02090-60731-8	36	6
60732	6" - bent nose	8-02090-60732-5	36	6
60733	8"	8-02090-60733-2	36	6
Groove Joint Pliers				
60741	10"	8-02090-60741-7	36	6
60743	12"	8-02090-60743-1	36	6
60745	16"	8-02090-60745-5	24	6



Long Reach Pliers

- Long reach design allows for greater access in tight hard to reach areas
- Serrated jaw provides greater gripping power

Part #	Length	UPC	Master	Inner
Diagonal Cutting Pliers				
60780	11"	8-02090-60780-6	24	6
Long Nose Pliers				
60779	11" - Flat	8-02090-60779-0	48	6
60771	11" - Straight	8-02090-60771-4	48	6
60773	11" - 45°	8-02090-60773-8	36	6
60774	11" - 90°	8-02090-60774-5	36	6



Part #	Length	UPC	Master	Inner
Hose Grip Pliers				
60775	11" - Small	8-02090-60775-2	48	6
60777	11" - Medium	8-02090-60777-6	48	6
60778	11" - Large	8-02090-60778-3	48	6

Part #	Length	UPC	Master	Inner
Long Nose Pliers				
60781	16" - Straight	8-02090-60781-3	24	6
60782	16" - 45°	8-02090-60782-0	24	6
60783	16" - 90°	8-02090-60783-7	24	6



Pistol Grip Pliers/Crimper 11400

- Ergonomic pistol grip handle provides greater gripping power while reducing hand fatigue
- Angled design for use in tight spaces & hard to reach areas
- Built in wire cutter & crimper for use with various electrical applications

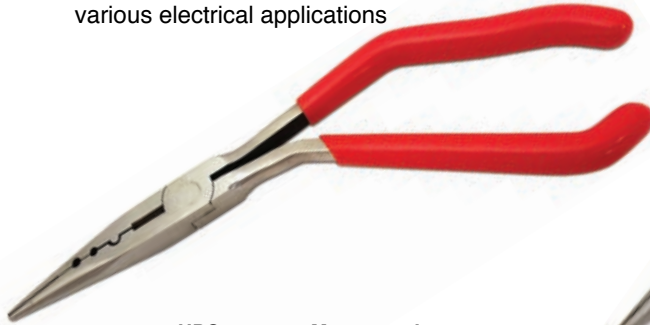

UPC	Master	Inner
8-02090-11400-7	36	6

16 in. XL Pistol Grip Needle Nose Pliers 11401



- Extra-long design for tight spaces and hard to reach areas
- Ergonomic pistol grip handles provide greater gripping power while reducing hand fatigue

UPC	Master	Inner
8-02090-11401-4	24	6

Locking Pliers

- Constructed from high quality chrome vanadium steel for strength and durability

Part #	Size	UPC	Master	Inner
Curved Jaw				
60752	5"	8-02090-60752-3	48	6
60754	7"	8-02090-60754-7	48	6
60756	10"	8-02090-60756-1	48	6
Straight Jaw				
60757	10"	8-02090-60757-8	48	6
Long Nose Pliers				
60758	6"	8-02090-60758-5	48	6
60760	9"	8-02090-60760-8	48	6



15 in. Long Reach Locking Pliers



- 15 inch extra long reach allows access into tight hard to reach areas
- Ideal for gripping, clamping and twisting
- Serrated jaw provides greater gripping power
- Pressure adjusting turnscrew
- Guarded trigger release
- Corrosion resistant finish

Part #	Type	UPC	Master	Inner
60762	Straight	8-02090-60762-2	24	6
60763	45°	8-02090-60763-9	24	6
60764	90°	8-02090-60764-6	24	6

Convertible Snap Ring Pliers 18400

- Overall Length: 7", width: 5", thickness: 0.91"
- Convertible retaining ring pliers
- Carbon steel with coated grip handles
- 4 Sets of tips included:
- 1.2mm - straight and 90° (black)
- 1.8mm - straight and 90° (chrome)

UPC	Master	Inner
8-02090-18400-0	48	8



Snap Ring Plier Set 18402

- For use with both internal and external snap rings
- Includes 4 interchangeable tips: (2) straight, (1) 90° and (1) 45°
- Comfort grip handles
- Effective range: 10 - 50 mm (3/8" x 2")

UPC	Master	Inner
8-02090-18402-4	60	6



24 in. Cable Cutter 11424

- Max Cutting Diameter: 1-5/16" (3.33cm)
- Max cutting load: 673N (151.3 lbs.)
- Drop forged chrome-moly jaws
- Heat treated handles for added strength and durability

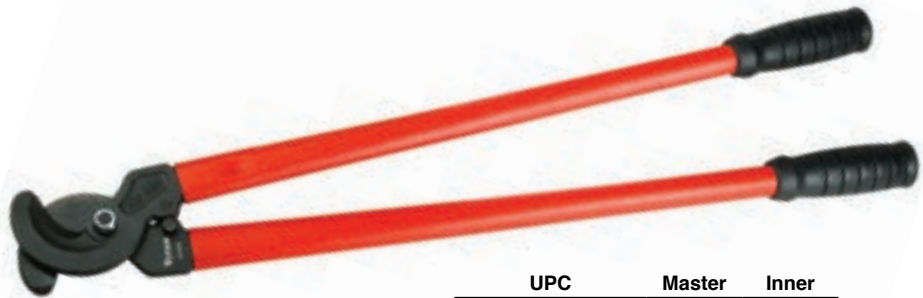

UPC	Master	Inner
8-02090-11424-3	8	4

Compound Action Cable Cutters 11470

- 10" overall height
- Meets or exceeds federal ANSI specification B107.16-1998
- Induction hardened, serrated blades
- Compound leverage cutters
- Quick and simple spring-free automatic latch design
- Cuts copper and aluminum electric cable up to 1/2" diameter
- Drop forged Chrome-Molybdenum Alloy steel blades are hardened to help maintain cutting edges
- New quick and simple spring-free automatic latch design (one hand release) provides safety and convenience
- Cuts the following: Copper and aluminum electric cable up to 2AWG (14mm) or 1/2" (12mm) diameter
- Includes reusable holster



UPC	Master	Inner
8-02090-11470-0	36	6



Aviation Snips

- Meets or exceeds federal ANSI/ASME spec B107.16-1998
- Chrome molybdenum steel construction
- Induction hardened, serrated edged blades
- Compound leverage cutters
- Cuts cold rolled and stainless steel
- Ships on re-usable holster package
- Overall length: 10"

Part #	Tip	UPC	Master	Inner
11460	Straight	8-02090-11460-1	36	6
11461	Right	8-02090-11461-8	36	6
11462	Left	8-02090-11462-5	36	6

Extra-Long Utility Snips 11471

- Overall length: 11-1/4"
- Meets or exceeds federal ANSI specification B107.16-1998
- Chrome-moly steel construction
- Induction hardened, serrated blades
- Compound leverage cutters
- Cuts cold rolled and stainless steel
- Includes reusable holster



UPC	Master	Inner
8-02090-11471-7	36	6

8 in. Multi-Purpose Utility Shears 12308

- Oversize Ergonomic handles for comfort
- Adjustable pivot point allow blade tension modification
- Left or right handed usage
- Excellent for cutting rubber, upholstery, plastic, canvas, fabric, string and many other materials
- Stainless steel blades
- Cutting length: 2-1/2", overall size 8"



UPC	Master	Inner
8-02090-12308-5	48	6

7-1/2 in. Multi-Purpose Shears 12345

- SUS 420J2 Japanese stainless steel, precision ground and hardened for long lasting sharp cutting edge
- Lightweight Polypropylene handles with ergonomic overmolded TPR grips to reduce user fatigue
- Spring loaded handles for easy use
- Extended tang for durability



UPC	Master	Inner
8-02090-12345-0	48	6

5-1/2 in. Multi-Purpose Electrical Shears 12346

- Heavy duty high carbon stainless steel with molybdenum and vanadium blades, precision hollow-ground and hardened for long-lasting edge.
- Ergonomic handles allow for both left and right hand usage.
- Micro-serration blades reduce slippage
- Light weight
- Includes shear storage belt holster



UPC	Master	Inner
8-02090-12346-7	48	6

Metal Shears

- Multi-purpose shears for cutting wire, tin, nails, wire mesh, aluminum and more
- Precise CNC grinding and vacuum heat treatment of cutting blades provide hardened edges that remain sharp and durable
- Precise enough to cut paper like scissors
- Auto release locking hook
- Long lasting chrome molybdenum jaw



Part #	Size	UPC	Master	Inner
12441	7"	8-02090-12441-9	72	12
12443	10"	8-02090-12443-3	40	10
12444	10" Offset	8-02090-12444-0	40	10

9 in. Mesh Shears 12442

- Multi-purpose shears for cutting wire, tin, nails, wire mesh, aluminum and more
- Precise CNC grinding and vacuum heat treatment of cutting blades provide hardened edges that remain sharp and durable
- Precise enough to cut paper like scissors
- Auto release locking hook
- Long lasting chrome molybdenum jaw



UPC	Master	Inner
8-02090-12442-6	72	12



18 in. Bolt Cutter 97005

- Chrome Molybdenum construction
- Comfort grip handles

UPC	Master	Inner
8-02090-97005-4	12	6

5 pc. Hammer Set 63125

- Set includes:
- (1) 16 oz. Ball Pein Hammer
- (1) 32 oz. Ball Pein Hammer
- (1) 32 oz. Rubber Mallet
- (1) 3 lb Sledge Hammer
- (1) 3 lb Cross Pein Hammer
- Comfortable, textured handles for handling ease



UPC	Master	Inner
8-02090-63125-2	4	1

5 pc. General Hammer Set 63126

- Set includes:
- (1) 16 oz. Dead Blow Hammer
- (1) 12 oz. Soft Face Hammer
- (1) 16 oz. Rubber Mallet
- (1) 2.5 lb Stoning Hammer
- (1) 16 oz. Ball Pein Hammer
- Comfortable, textured handles for handling ease



UPC	Master	Inner
8-02090-63126-9	4	1

4 pc. Dead Blow Hammer Set 63144

- Set Includes:
- (1) 8oz, (1) 16oz, (1) 24oz, & (1) 32oz
- Comfortable, textured handles for handling ease



UPC	Master	Inner
8-02090-63144-3	4	1

6 pc. General Hammer Set 63136

● Set Includes:

- (1) 3 lb Cross Pein Hammer
- (1) 3 lb Sledge Hammer
- (1) 32 oz. Rubber Mallet
- (1) 32 oz. Ball Pein Hammer
- (1) 16 oz. Ball Pein Hammer
- (1) 32 oz. Dead Blow Hammer



UPC	Master	Inner
8-0209-63136-8	1	1

Hammers and Mallets

- Comfortable, textured handles for handling ease

Size	Part No	Master Qty.	Inner Qty.	Item UPC
16 oz Claw Hammer	63020	6	36	8-02090-63020-0
3 lb. Cross Pein Hammer	63004	6	12	8-02090-63004-0
3 lb. Sledge Hammer	63000	6	12	8-02090-63000-2
2.5 lb. Stoning Hammer	63233	6	12	8-02090-63233-4
Ball Pein Hammers				
8 oz.	63308	6	36	8-02090-63308-9
12 oz.	63312	6	36	8-02090-63312-6
16 oz.	63316	6	36	8-02090-63316-4
24 oz.	63016	6	24	8-02090-63016-3
32 oz.	63024	6	24	8-02090-63024-8
Dead Blow Hammers				
8 oz.	63008	6	36	8-02090-63008-8
16 oz.	63116	6	36	8-02090-63116-0
24 oz.	63124	1	1	8-02090-63124-5
32 oz.	63032	6	24	8-02090-63032-3
Non-Sparking Hammers				
2 lb.	63216	6	24	8-02090-63216-7
3 lb.	63040	6	12	8-02090-63040-8
3 lb.	63064	6	12	8-02090-63064-4
Rubber Mallets				
16 oz.	63217	6	36	8-02090-63217-4
32 oz.	63232	6	24	8-02090-63232-7



3 pc. Indexable Pry Bar Set 12216

- 3 Pc pry bar set includes 10", 12", & 15"
- Ideal for prying seals, bearings, manifolds, oil pans, axles, drive shafts and fuel injectors
- Indexing head locks into 8 incremental angles
- Thumb lever for quick and easy lock and release of pry head
- Chrome-molybdenum blade tip
- Meets International ANSI, Federal Spec, & DIN standards

UPC	Master	Inner
8-02090-12216-3	10	1



Indexable Pry Bars

- Ideal for prying seals, bearings, manifolds, oil pans, axles, drive shafts and fuel injectors
- Indexing head locks into 8 incremental fixed angles
- Thumb lever for quick and easy lock and release of pry head
- High carbon steel construction

Part #	Size	UPC	Master	Inner
12212	12"	8-02090-12212-5	30	5
12215	15"	8-02090-12215-6	30	5



Indexable Pry Bars

- Push button quick easy lock and release of pry head
- Indexing Range: 180 Degrees
- Indexing head locks at 11 incrementally fixed angles
- Black Manganese Phosphate Finish
- Chrome-Moly Construction

Part #	Size	UPC	Master	Inner
17808	8"	8-02090-17808-5	48	6
17812	12"	8-02090-17812-2	30	5
17816	16"	8-02090-17816-0	24	6
17824	24"	8-02090-17824-5	6	3
17833	33"	8-02090-17833-7	6	3

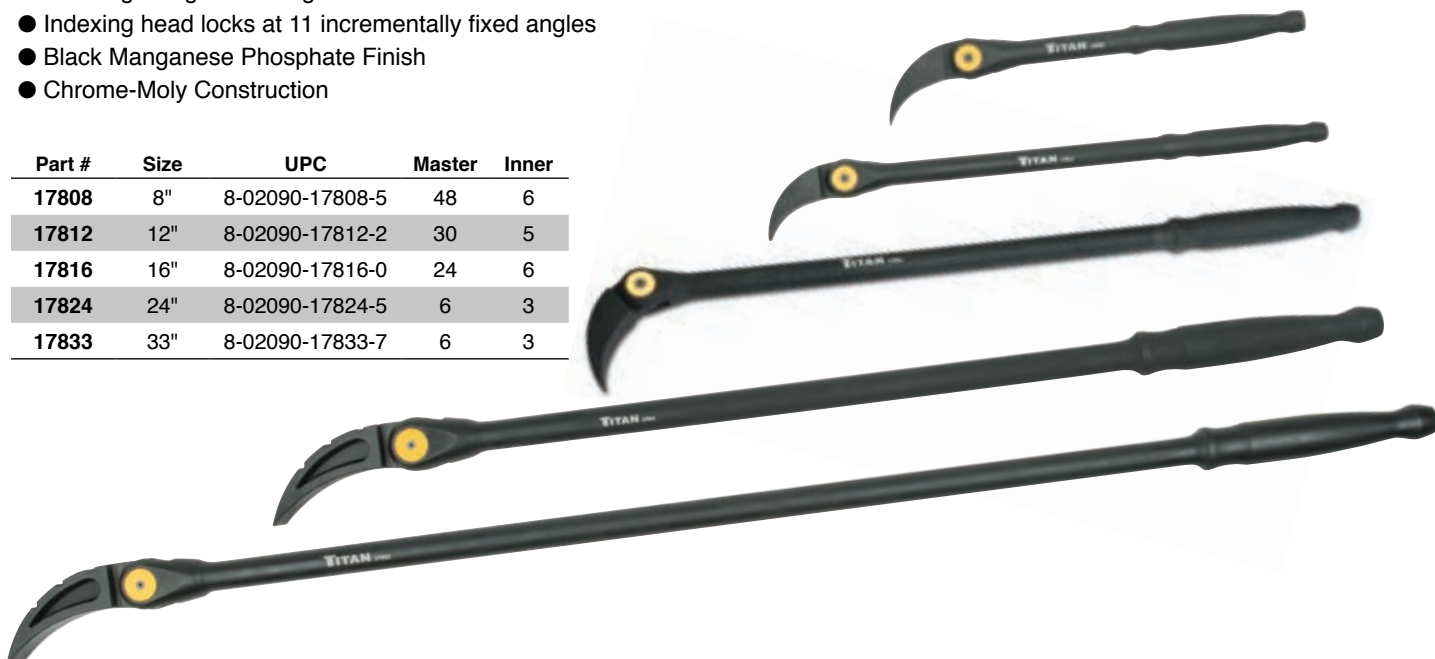

4 pc. Pry Bar Set 17101

- Includes 8, 12, 18 and 24 inch pry bars
- Tough poly-propylene handle grips
- Forged carbon steel with black oxide finish



UPC	Master	Inner
8-02090-17101-7	6	1

4 pc. Pry Bar Set 17102

- Sized included: 8, 12, 18, 24 in. pry bars
- TPR soft grip handles
- Chrome vanadium steel shafts with sand satin finish



UPC	Master	Inner
8-02090-17102-4	5	1

Digital Circuit Tester 11436

- For use on 6, 12 & 24V DC systems
- Used to detect voltage, power, ground and circuit integrity
- LCD display provides a 'no guess' voltage value of the circuit
- Backlit LED indicates Green for Ground or Red for Power
- Provides 1-handed operation of CT & digital display of a multi meter
- One hand free to jiggle wires, replace fuse, or operate a switch
- Surge protected circuitry
- Computer safe <10mA circuit draw for confident testing



Adjustable Wire Stripper 11469

- Cuts and strip solid or stranded 12-22 gauge wire
- Automatically adjusts to wire size
- Handles single or multiple conductor wire
- Easy to use - yields clean, nick-free results every time
- Not designed to strip teflon or similar insulations



7/16 in. Coaxial Nut Combination Speed Wrench 14614

- Designed for the rapid removal or installation of 7/16" coaxial nuts
- Features a 15-degree offset 12 point box-end
- Constructed from chrome vanadium steel for strength and durability with mirror finish

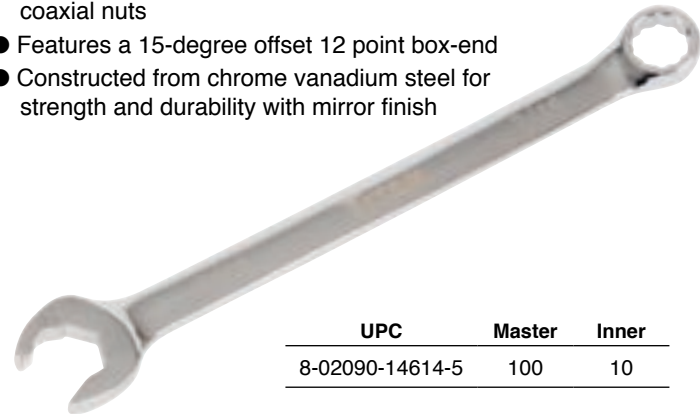

Coaxial Cable Stripper 11474

- Strips and cuts cables: RG6/RG6-OS/RG59
- Provides one-step preparation for drop cables
- Cassette blades require no adjustment and remove the proper length of jacket
- Stripping cassette contains pre-set SK5 cutting blades and depth gauge



Self Adjusting Wire Stripper 11475

- Self-adjusting wire stripper for 10-24 AWG wires
- Micro adjustable knob for gauges smaller than 20 AWG
- Built-in wire cutter
- Crimps 10-22 AWG insulated, 10-22 AWG non-insulated and 7-9mm ignition terminals
- Comfort grip handles reduce hand fatigue





3 pc. Electrical Tool Set 11476

- Set Includes: Cutter, Stripper, and Crimper
- Cutting Capacity: 30-10Awg
- Stripping Capacity: 22-10Awg
- Crimping Capacity: Insulated Terminals from 22-10AWG
- Overall length of tools: 5-1/2"
- For hard to reach applications
- Spring loaded to reduce fatigue
- Comfortable TPR handles for maximum grip

UPC	Master	Inner
8-02090-11476-2	48	8

Stripping/Crimping Pliers 11478

- Easily strips & cuts solid (AWG 8-20) & stranded wire (8-22ga)
- Narrow, serrated plier nose to pull, loop & bend wire
- Solidly crimps both insulated and non-insulated terminals along with 7mm to 9mm ignition terminals



UPC	Master	Inner
8-02090-11478-6	60	10

Pistol Grip Wire Stripper 11479

- Strips and Cuts: 22-12 gauge stranded wire
- For fast, easy and accurate wire stripping
- Adjustable hardened steel blades
- Locking handle
- Includes wire cutter



UPC	Master	Inner
8-02090-11479-3	60	10

Ratcheting Wire Terminal Crimper 11477

- Ratcheting mechanism design
- Adjustable crimping compression
- Steel jaw
- Color coded wire sizes
- red: 22-18AWG-DIN 0.5-1.0mm
- blue: 16-14AWG/DIN 1.5mm-2.5mm
- yellow: 12-10AWG/DIN 4-6mm



UPC	Master	Inner
8-02090-11477-9	40	10

Ratcheting Crimper System

Quick Change Jaw Design For Use With Multiple Dies



QUICK CHANGE JAW DESIGN FOR EASY DIE CHANGE

RATCHETING MECHANISM RELEASES AFTER FULL COMPRESSION

CORROSION RESISTANT CARBON STEEL FRAME

Ratcheting Heat Shrink Terminal Crimper 11955

- Crimper loaded with A5 Die for use with closed end connectors & heat shrink terminals
- Corrosion resistant carbon steel frame
- Quick change jaw design
- Comfort grip handles
- Safety release
- Adjustable compression
- Ratcheting mechanism releases after full compression
- Can be used with other TITAN interchangeable crimping dies

Includes A5 Die

Closed End Connector & Heat Shrink Terminals

AWG 22-16 / 16-14 / 12-10 0.5-1.5 / 1.5-2.5 / 4.0-6.0 mm



11906



UPC	Master	Inner
8-02090-11955-2	40	10

Ratcheting Spark Plug Connector Crimper 11956

- Loaded with H1 Die for crimping spark plug wire connectors
- Corrosion resistant carbon steel frame
- Quick change jaw design
- Comfort grip handles
- Safety release
- Adjustable compression
- Ratcheting mechanism releases after full compression
- Can be used with other TITAN interchangeable crimping dies

Includes H1 Die

Spark Plug Connectors

AWG 22-16 / 16-14 / AWG 17
DIN 1.0 mm²



11916









UPC	Master	Inner
8-02090-11956-9	40	10

7 pc. Ratcheting Terminal Crimping Set 11950

- For use with the most common types of solderless terminals
- Comes with (1) Ratcheting Crimper & (6) Interchangeable dies
- Quick change jaw design allows dies to be easily changed out
- Ratcheting action and full cycle quick-release feature for secure uniform crimps
- Built-in safety release allows crimper to release mid-cycle
- Adjustable compression wheel
- Corrosion resistant carbon steel frame
- Comfort grip handles reduce hand fatigue
- Can be used with other TITAN interchangeable crimping dies



UPC	Master	Inner
8-02090-11950-7	10	1

Set Die Contents					
A	A2	A3	A4	A5	H1
Insulated Terminals AWG 22-18 / 16-14 / 12-10 0.5-1.0 / 1.5-2.5 / 4-6 mm ²	Fully Insulated Quick Disconnect Terminals AWG 22-18 / 16-14 / 12-10 0.5-1.0 / 1.5-2.5 / 4-6 mm ²	Mini Insulated Terminals AWG 26-22 / 24-18 / 22-16 0.1-0.5 / 0.25- 1.0 / 0.5-1.5 mm ²	Insulated Flag Terminals AWG 22-18 / 16-14 0.5-1.0 / 1.5-2.5 mm ²	Closed End Connector & Heat Shrink Terminals AWG 22-16 / 16-14 / 12-10 0.5-1.5 / 1.5-2.5 / 4.0-6.0 mm ²	Spark Plug Connectors AWG 17 DIN 1.0 mm ²
					
11901	11903	11904	11905	11906	11916

Ratcheting Crimper Frame (empty)

11900

- For Use With Titan 11900 Series Quick Change Crimper Dies









UPC	Master	Inner
8-02090-11900-2	120	10

Insulated, Non-Insulated & Open Barrel Terminal Dies

Part #	DIE	Specification & Component	UPC	Master	Inner
11901	A	 Insulated Terminals AWG 22-18 / 16-14 / 12-10 0.5-1.0 / 1.5-2.5 / 4-6 mm ²	8-02090-11901-9	120	10
11902	A1	 Heat Shrink Butt Connectors AWG 22-18 / 16-14 / 12-10 / 8 DIN 0.5-1.0 / 1.5-2.5 / 4-6 / 10 mm ²	8-02090-11902-6	120	10
11903	A2	 Fully Insulated Quick Disconnect Terminals AWG 22-18 / 16-14 / 12-10 0.5-1.0 / 1.5-2.5 / 4-6 mm ²	8-02090-11903-3	120	10
11904	A3	 Mini Insulated Terminals AWG 26-22 / 24-18 / 22-16 0.1-0.5 / 0.25-1.0 / 0.5-1.5 mm ²	8-02090-11904-0	120	10
11905	A4	 Insulated Flag Terminals AWG 22-18 / 16-14 0.5-1.0 / 1.5-2.5 mm ²	8-02090-11905-7	120	10
11906	A5	 Closed End Connector & Heat Shrink Terminals AWG 22-16 / 16-14 / 12-10 0.5-1.5 / 1.5-2.5 / 4.0-6.0 mm ²	8-02090-11906-4	120	10
11915	H1	 Spark Plug Connectors AWG 17 DIN 1.0 mm ²	8-02090-11915-6	120	10
11946	H6	 Delphi Weather Pack Terminals AWG 22 / 20-18 DIN 0.35 / 0.5-0.8 mm ²	8-02090-11946-0	120	10
11947	H7	 Delphi Weather Pack Terminals AWG 16-14 / 12 DIN 1.0-2.0 / 3.0 mm ²	8-02090-11947-7	120	10

Deutsch Terminal Dies

Part #	DIE	Specification & Component	UPC	Master	Inner
11961	K1	 Deutsch Terminals AWG 14 / 12	8-02090-11961-3	120	10
11962	k2	 Deutsch Terminals AWG 10 / 12	8-02090-11962-0	120	10
11963	K3	 Deutsch Terminals AWG 18 / 16 / 14	8-02090-11963-7	120	10
11964	K4	 Deutsch Terminals AWG 20 / 18 / 16	8-02090-11964-4	120	10
11965	K5	 Deutsch Terminals AWG 20 / 18-16	8-02090-11965-1	120	10
11966	K6	 Deutsch Terminals AWG 16 / 14 / 12	8-02090-11966-8	120	10

**Dies are for use with
Ratcheting Crimper**
Part No. 11900



Heavy Duty Hand Riveter 15050

- Can be used with steel, aluminum, stainless & plastic rivets
- Rivet sizes: 1/8"-1/4"
- Spent mandrel catch cup
- Compound lever action for ease of operation
- Wrench and nosepieces store in handles



UPC	Master	Inner
8-02090-15050-0	16	1

10 in. Hand Riveter With Rivets 15052

- For use with 3/32", 1/8", 5/32" & 3/16" steel, aluminum, stainless & plastic rivets
- 4 Interchangeable Nosepieces
- Includes 60 Rivets
- Anti-slip cushion grip handle



UPC	Master	Inner
8-02090-15052-4	24	6



Multi-Function Tools

- Folding compact tool set includes: pliers, wire cutter, nail puller, Phillips screwdriver, lock, screwdriver, can opener, file, saw, large blade, hole punch, and hammer head
- Perfect for auto, truck, boat, RV, motorcycle, bicycle, and many other uses
- Stainless Steel construction
- Anodized handle

Part #	UPC	Master	Inner
12135 RED	8-02090-12135-7	48	6
12136 BLUE	8-02090-12136-4	48	12

Folding Knife with Locking Wrench 11110

- Quick adjusting grooved internal wrench jaws
- Folding knife with locking blade
- Blade length: 3in
- Jaw opening: 0.25in – 0.75in
- Overall length (closed): 6in
- Overall length (open): 8.85in
- Stainless steel construction



UPC	Master	Inner
8-02090-11110-5	48	6

3 pc. Utility Tool Set 11065

- 3 piece set includes:
- Mini magnetic tray
- Telescoping inspection mirror
- Telescoping magnetic pickup tool

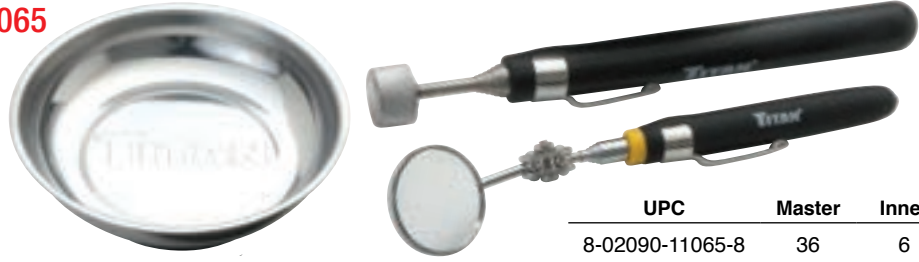

UPC	Master	Inner
8-02090-11065-8	36	6

2 pc. Telescoping Tool Set 11187

- Set Includes:
- Telescoping Inspection Mirror & Magnetic Retriever
- 1"x 2" Oval Mirror
- Telescopes from 9-1/2" to 28"
- 5-Section Stainless Steel Shaft
- Comfortable textured cushion grip
- Powerful 3 lb. magnet
- Telescopes from 5-1/2" to 21-7/8" Shielded sides for targeted pickups Comfortable textured cushion grip



UPC	Master	Inner
8-02090-11187-7	120	20

2 pc. Utility Tool Set 11188

- Set Includes:
- Telescoping Inspection Mirror & Magnetic Retriever
- 2" Diameter Mirror
- Telescopes from 9-1/2" to 28"
- 5-Section Stainless Steel Shaft
- Comfortable textured cushion grip
- Powerful 5 lb. magnet
- Telescopes from 6-1/2" to 33" Shielded sides for targeted pickups Comfortable textured cushion grip



UPC	Master	Inner
8-02090-11188-4	72	12

Telescoping Inspection Mirrors

11158



11185



11186/11193



- 5-Section stainless steel shaft
- Comfortable textured cushion grip

11666



Item#	Size	Range	UPC	Master	Inner
11185	1" x 2" Oval	7-1/2" to 21"	8-02090-11185-3	20	120
11158	1-1/8" Round	6-7/8" to 19"	8-02090-11158-7	20	120
11186	2" Round	9.5" to 28.5"	8-02090-11186-0	20	120
11193	2" Round	9.5" to 28"	8-02090-11193-8	20	120
11666	2" x 3.5" Rectangle	7-1/2" to 21"	8-02090-11666-7	20	120



Telescoping Magnetic Pick Up Tools

- Powerful magnet features shielded sides for targeted pickups
- Ideal for retrieving dropped parts, fasteners, and tools
- Comfortable textured cushion grip handle

Item#	Capacity	Range	UPC	Inner	Master
11159	3lb.	5-1/2" to 21-7/8"	8-02090-11159-4	20	120
11191	3lb.	9.5" to 28.5"	8-02090-11191-4	20	120
11192	5lb.	9.5" to 28"	8-02090-11192-1	20	120
11190	16lb.	7-1/2" to 21"	8-02090-11190-7	20	120

3-in-1 Lighted Retriever 11064

- Overall length: 24 inches
- Flexible shaft for use in confined areas
- Adjustable retriever claw
- Inspection LED light
- Magnet holds up to 3lbs
- Aluminum handle and head
- Steel and chrome plated flexible shaft

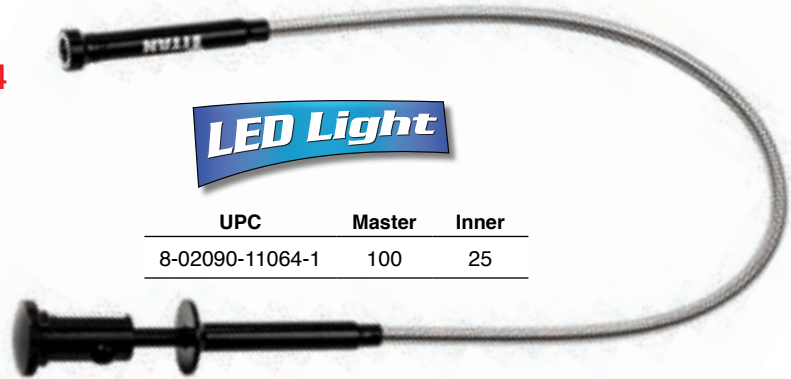

UPC	Master	Inner
8-02090-11064-1	100	25

24 in. Flexible Claw Pickup Tool 11162

- 4-finger claw design for retrieving dropped parts, fasteners, and tools
- Claws can open up to 1" wide
- 24" flexible body holds shape to reach around various spaces
- TPR handle and rounded knob for extra grip comfort

UPC	Master	Inner
8-02090-11162-4	48	12

24 in. Flexible Magnetic Pickup Tool 11163

- Powerful 3 lbs magnetic pick up tool w/ shielded sides for targeted pick-up
- Ideal for retrieving dropped parts, fasteners, and tools
- 24" flexible body holds shape to reach around various spaces
- TPR handle and rounded knob for extra grip comfort

UPC	Master	Inner
8-02090-11163-1	48	12

2.2x Magnifying Glass 15036

- Non-distorting optical grade glass lens
- Comfortable TPR rubber grip handle
- TPR rubber framing for extra protection
- Lens diameter measures 2-7/8"
- 7-1/4" overall length



UPC	Master	Inner
8-02090-15036-4	24	144

4.4x Magnifying Glass with LED Light 15028

- Non-distorting optical grade glass lens
- Comfortable TPR rubber grip handle
- TPR rubber framing for extra protection
- Slide on/off switch to control light
- Lens measures 2-7/8"
- 7-1/4" overall length
- Includes 3 LR44 batteries



UPC	Master	Inner
8-02090-15028-9	24	144

3 pc. Magnetic Tray Set 21260

- Contains (1) ea: 3", 4-1/4" and 5-7/8" diameter tray
- Stainless steel, magnetic trays
- Non-marring rubber covered magnetic base prevents scratching



UPC	Master	Inner
8-02090-21260-4	36	6

4-1/4 in. Round Magnetic Parts Tray 11189

- 4-1/4" Stainless steel dish
- Perfect for holding small parts, hardware and fasteners in place
 - Sticks to any ferrous metal surface - it even works upside down!
 - Rubber covered magnetic base prevents scratching



UPC	Master	Inner
8-02090-11189-1	60	10

5 7/8 in. Round Magnetic Tray 21261

- 5-7/8" diameter stainless steel dish
- 7/8" Deep
- Perfect for holding parts, hardware and fasteners in place
- Sticks to any ferrous metal surfaces
- Non marring rubber covered magnetic base



UPC	Master	Inner
8-0209-021261-1	40	1

Rectangular Magnetic Parts Tray 21265

- Size: 5-3/8" x 9-3/8", 1-1/4" deep
- Stainless steel dish
- Perfect for holding parts, hardware and fasteners in place
- Sticks to any ferrous metal surfaces
- Non-marring rubber covered magnetic base prevents scratching

UPC	Master	Inner
8-02090-21265-9	24	6



6-1/2 in. x 14 in. Rectangular Magnetic Parts Tray 21263

- Size: 6-1/2" x 14" stainless steel dish, 1" deep
- Stainless steel
- Perfect for holding small parts, hardware and fasteners in place
- Sticks to any ferrous metal surface
- Non-marring rubber covered magnetic base prevents scratching

UPC	Master	Inner
8-02090-21263-5	12	6



10-1/2 in. x 11-1/2 in. Large Square Magnetic Parts Tray 21262

- Size: 10-1/2" x 11-1/2", 1" deep
- Stainless steel
- Perfect for holding small parts, hardware and fasteners in place
- Sticks to any ferrous metal surface
- Non-marring rubber covered magnetic base prevents scratching

UPC	Master	Inner
8-02090-21262-8	12	6



Mini Magnetic Tray 11195

- Size: 8-7/8 x 2-1/2, deep: 3/4"
- Stainless steel dish
- Perfect for holding small parts, hardware and fasteners in place
- Sticks to any ferrous metal surface
- Non-marring rubber covered magnetic base prevents scratching



UPC	Master	Inner
8-02090-11195-2	48	12

5-7/8 in. x 2-1/2 in. Mini Rectangular Magnetic Parts Tray 11196

- Size: 5-7/8 x 2-1/2", 5/8" deep
- Stainless steel
- Perfect for holding small parts, hardware and fasteners in place
- Sticks to any ferrous metal surface
- Non-marring rubber covered magnetic base prevents scratching



UPC	Master	Inner
8-02090-11196-9	48	12

Mini Magnetic Parts Tray 11194



- 4-1/4" Stainless steel dish
- Built-in hang hole
- Perfect for holding small parts, hardware and fasteners in place
- Sticks to any ferrous metal surface
- Rubber covered magnetic base prevents scratching

UPC	Master	Inner
8-02090-11194-5	100	10

10-1/2 in. Magnetic Strainer 11180



- 11" diameter x 4" deep
- Great for collecting small metal items such as tools, bolts, nails, screws, and fasteners
- Anti-rust, durable, stainless steel strainer is perfect for washing dirty tools
- Tools can be attracted firmly during flushing
- Rubber coated magnet prevents scuffing and scratching surfaces

UPC	Master	Inner
8-02090-11180-8	12	6

Fractional Digital Caliper 23173

- Electronic Digital caliper with Fractional Display
- Easy to read large LCD display of decimal inch, millimeter, and fractional increments
- Use for inside, outside, step, depth, and scribe measurements
- 0" to 6" measurement range (0mm to 150mm)
- Zero positioning in all measuring types
- Features automatic shut off to conserve battery life
- Fine adjust thumbwheel
- Lock knob
- Stainless steel components
- Protective storage case
- Includes 2 batteries



UPC	Master	Inner
8-02090-23173-5	24	6

Electronic Digital Caliper 23175

- Use for inside, outside and depth measurements
- 6" range (150mm)
- Easy to read large LCD display
- Set zero at any position in measuring range
- Fine adjust thumbwheel
- Lock knob
- Stainless steel components
- Protective storage case
- Includes battery



UPC	Master	Inner
8-02090-23175-9	24	6

Composite Digital Caliper 23171

- Use for inside, outside and depth measurements
- 6" range (150mm)
- Easy to read large LCD display
- Set zero at any position in measuring range
- Includes (1) 1.5V Battery



UPC	Master	Inner
8-02090-23171-1	48	12

25 ft. 2 pk. Tape Measure 10901

- Contains two 25' x 1" tape measures
- Easy, quick-read markings
- Tough, impact resistant plastic case
- Ergonomic cushion grips for maximum comfort
- Hands-free blade lock



UPC	Master	Inner
8-02090-10901-0	24	6

4 pc. Tape Measure Set 10902

- Contains 12', 16', 25' and 33' tape measures
- Easy, quick-read markings
- Tough, impact resistant plastic cases
- Ergonomic cushion grips for maximum comfort
- Hands-free blade locks



UPC	Master	Inner
8-02090-10902-7	12	6

2 pc. Combo Dual Rule Tape Measure Set 10903



- Includes 12 ft. and 25 ft. tape measures
- Dual-Rule™ Standard and Metric scales
- Quick-Read blade markings
- Comfort grip sleeve
- Hands free blade lock

UPC	Master	Inner
8-02090-10903-4	24	6

4 pc. Tape Measure Set 17504



- Contains 12', 16', 25' and 33' tape measures
- Easy, quick-read markings
- Tough, impact resistant plastic cases
- Ergonomic cushion grips for maximum comfort
- Hands-free blade locks

UPC	Master	Inner
8-02090-17504-6	12	6

12 ft. Tape Measure 10904



- 12' x 5/8" blade
- Easy, quick-read markings
- Tough, impact resistant plastic case
- Ergonomic cushion grips for maximum comfort
- Hands-free blade lock

UPC	Master	Inner
8-02090-10904-1	48	6

25 ft. Tape Measure 10906



- 25' x 1" blade
- Easy, quick-read markings
- Tough, impact resistant plastic case
- Ergonomic cushion grips for maximum comfort
- Hands free blade lock

UPC	Master	Inner
8-02090-10906-5	36	6

25 ft. Dual-Rule Tape Measure 10907



- Dual-Rule Standard and Metric scales
- Quick-Read blade markings
- Comfort grip sleeve
- Hands free blade lock
- 25' x 1" blade

UPC	Master	Inner
8-02090-10907-2	36	6

25 ft. Tape Measure 11124



- 25' x 1" blade
- Easy, quick-read markings
- Tough, impact resistant plastic case
- Ergonomic cushion grips for maximum comfort
- Hands-free blade lock

UPC	Master	Inner
8-02090-11124-2	60	6

16 ft. Tape Measure 10905



- 16' x 3/4" blade
- Easy, quick-read markings
- Tough, impact resistant plastic case
- Ergonomic cushion grips for maximum comfort
- Hands-free blade lock

UPC	Master	Inner
8-02090-10905-8	48	6

33 ft. Tape Measure 10908



- 33' x 1" blade
- Easy, quick-read markings
- Tough, impact resistant plastic case
- Ergonomic cushion grips for maximum comfort
- Hands-free blade lock

UPC	Master	Inner
8-02090-10908-9	24	6

Hose and Cotter Pin Remover 15093

- Angled, pointed tip allows for the separation of hoses from fittings and clamps
- Unique angle provides needed leverage to remove cotter pins from most applications



UPC	Master	Inner
8-02090-15093-7	72	12

4 pc. Seal and O-Ring Remover Set 17004

- Allows for easy removal of seals and o-rings without damaging the seal or the finished surface
- Set Includes:
 - (2) Contoured Tip & (2) Spoon Tip
 - Lengths: 5-1/2" & 8-1/2"
 - CRV Steel Shaft



UPC	Master	Inner
8-02090-17004-1	24	6

4 pc. Long Pick Set 17221

- Comfortable TPR sure-grip handles
- Chrome plated shafts
- Includes 4 picks: Curved, 90 degree, Offset and Straight
- Overall Length: 16"

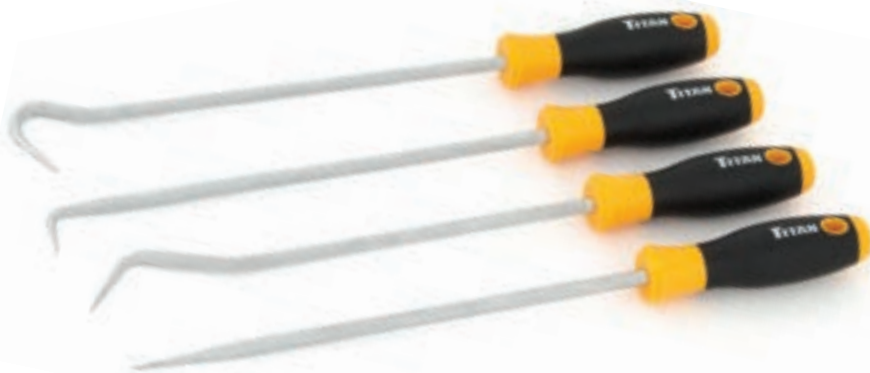

UPC	Master	Inner
8-02090-17221-2	12	6

4 pc. Pick and Hook Set 17222

- Comfortable TPR sure-grip handles
- Chrome plated shafts
- Includes 4 picks: Curved, 90 degree, Offset and Straight
- Overall Length: 8.5"



UPC	Master	Inner
8-02090-17222-9	18	6

4 pc. Jumbo Pick and Hook Set 17223

- Comfortable TPR sure-grip handles
- Chrome plated shafts
- Includes 4 picks: Curved, 90 degree, Offset, and Straight
- Overall Length: 9"



UPC	Master	Inner
8-02090-17223-6	36	6

4 pc. Jumbo Bolstered Pick and Hook Set **17224**

- 4 picks: Straight, 90 degree, Offset and Curved
- Comfortable TPR grips
- Chrome plated chrome-vanadium steel shafts

UPC	Master	Inner
8-02090-17224-3	12	6



12 pc. Pick Set **17612**

- 4 Utility picks: Straight, 90°, 1/4" radius and 1/8" radius
- 4 Screwdrivers: #000 and #00 Phillips; 3/32" and 1/8" slotted
- 4 Star drivers: T5, T7, T8 and T10
- Comfortable TPR grips
- Chrome plated chrome-vanadium steel shafts
- Handy nylon storage pouch

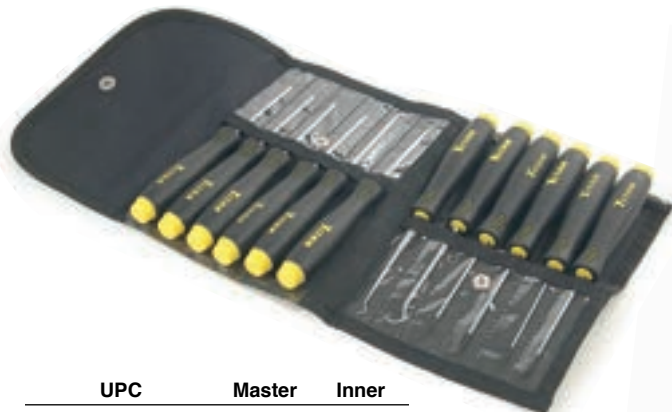

UPC	Master	Inner
8-02090-17612-8	12	6

O-Ring and Hook Scribe Set **17702**

- Great for scribing metal, picking "O" ring from grooves, retrieving parts from hard to reach areas
- Set includes:
 - (1) Combination pick and hook pick
 - (1) 90 degree pick and straight pick
- Knurled handles for better grip
- Overall Length: 8.5"

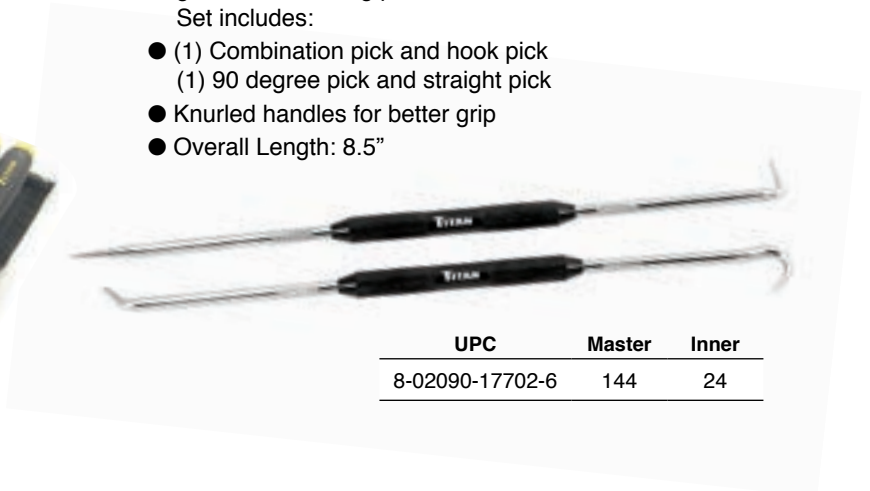

UPC	Master	Inner
8-02090-17702-6	144	24

4 pc. Pick and Hook Set **17710**

- Includes 4 picks: Curved, 90 degree, Offset and Straight
- Comfortable TPR sure-grip handles
- Chrome plated shafts



UPC	Master	Inner
8-02090-17710-1	48	12

4 pc. Mini Pick and Hook Set **17712**

- Includes 4 picks: Curved, 90 degree, Offset, and Straight
- Comfortable TPR sure-grip handles



UPC	Master	Inner
8-02090-17712-5	72	12

3/8 in. Stud Extractor 16023

- Fits 1/4" to 1/2" (6 - 12mm) studs
- Impact gun compatible
- Ideal for removing stripped, rusted, broken or smooth studs
- Hex drive can be a driver with a wrench, ratchet, or impact tool



UPC	Master	Inner
8-02090-16023-3	48	6

Internal Pipe Wrenches

- For internal diameter applications
- Removes broken pipe threads, pipe fragments, pipe plugs & fittings



Part #	Size (in.)	UPC	Master	Inner
11498 3-pc set	3/8, 1/2 & 3/4	8-02090-11498-4	40	10
11483	3/8	8-02090-11483-0	100	10
11484	1/2	8-02090-11484-7	100	10
11485	3/4	8-02090-11485-4	100	10

Mini Tubing Bender 11487

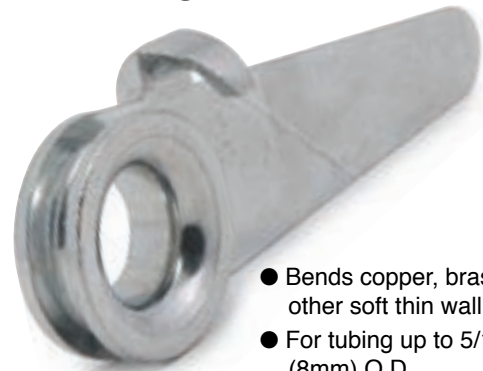

- Bends copper, brass and other soft thin wall tubing
- For tubing up to 5/16 (8mm) O.D

UPC	Master	Inner
8-02090-11487-8	144	24

Tubing Bending Pliers 11488

- Bends copper, brass and other soft thin wall tubing
- For 3/16, 1/4, 5/16 & 3/8" O.D. tubing

UPC	Master	Inner
8-02090-11488-5	24	12



180 Degree Tubing Bender 11489

- Makes short, smooth radius bends up to 180 degrees
- Calibration gauge to indicate angle of bend
- For copper, aluminum and thin wall tubing
- 3/8" maximum bending capacity
- 180 degree maximum bending capacity
- For 3/8, 5/16, 1/4" O.D. Tubing

UPC	Master	Inner
8-02090-11489-2	24	12

1/8 in. to 7/8 in. Mini Tubing Cutter 11490

- Cuts 1/8" - 7/8" (3-22 mm)
- Change out wheels with only a screwdriver
- Comes with 1 blade
- .75" diameter (19mm)
- Cuts copper & brass tube
- Replacement blade, Titan part 11492 for copper/brass tube & 11493 for stainless steel



UPC	Master	Inner
8-02090-11490-8	120	12

1/8 in. to 1-3/8 in. Tubing Cutter 11491

- Cuts 1/8" - 1 3/8"
- Four roller tracking system keeps tube from threading
- Full stop feed system prevents wheels and rollers from coming into contact
- Change out wheels with only a screwdriver
- Comes with 1 blade .75" diameter (19mm)
- Cuts copper & brass tube
- Replacement blade, Titan part 11492 for brass & copper tubing & 11493 for stainless steel tubing



UPC	Master	Inner
8-02090-11491-5	36	6

Tubing Cutter Replacement Blades

- Replacement tubing cutter blade for Titan # 11490 & 11491
- .75" diameter (19 mm)

Part #	Usage	UPC	Master	Inner
11492	copper and brass tubing	8-02090-11492-2	400	1
11493	stainless steel tubing	8-02090-11493-9	100	1





Replacement
Blade
Available



Ratcheting PVC Pipe Cutter

- Cuts rubber or PVC pipe
- Maximum diameter: 1-5/8" pipe
- Stainless steel blade
- Flip catch holds handles closed for safety
- Overall length: 9"

Part #	UPC	Master	Inner
15063	8-02090-15063-0	36	6
15067 Replacement Blade	8-02090-11484-7	100	10

12 in. Basin Wrench 11499

- Steel forged, self adjusting milled jaws
- Sliding T-handle for work in confined spaces
- 90 degree pivoting head

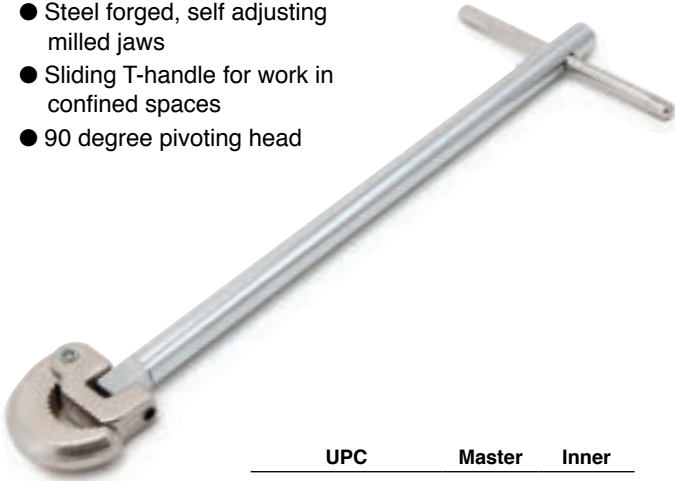

UPC	Master	Inner
8-02090-11499-1	40	20

Single Flare Tool 15062

- For use with soft brass, copper, and aluminum tubing
- 45 degree flare and taper
- Die sizes: 3/16, 1/4, 5/16, 3/8, 1/2, & 5/8"
- Works well with soft tubing

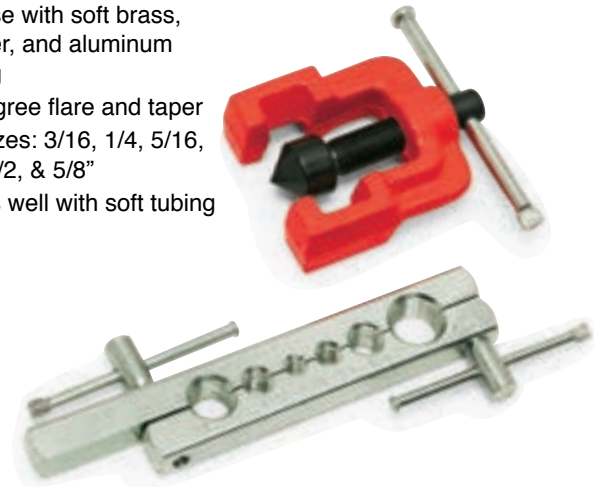

UPC	Master	Inner
8-02090-15062-3	24	6

Plumbers Brush 15064

- For 1/2" & 3/4" tubing I.D. and O.D.
- Make cleaning tubing and fittings prior to soldering easy and effective
- Ensures proper surface penetration and good solder joint



UPC	Master	Inner
8-02090-15064-7	96	12

Water Heater Socket 32948

- 1/2" Dr
- 6pts, 1-1/2" deep



UPC	Master	Inner
8-02090-32948-7	24	6

Carbide Scrapers

- For use on automotive, industrial/construction, marine, woodworking, and household applications and projects
- Can be used to remove gaskets, carbon, rust, varnish, glue, concrete, barnacles, metal buildup and a wide range of materials from varied hard surfaces. It can also be used to debur aluminum, steel, plastic, copper, brass, etc and to ease wood edges and corners. This is NOT to be used to scrape glass or as a windshield scraper. All 8 edges are extremely sharp for precise work
- Features a long lasting durable tungsten tip
- 6" sturdy comfortable handle with 8" overall length



Part #	Width (in.)	UPC	Master	Inner
17010	5/8	8-02090-17010-2	48	6
17011	1-1/4	8-02090-17011-9	48	6

1 in. Carbon Scraper 12462

- Chrome Vanadium construction
- 1" wide scraper blade
- Comfortable trilobular handle for maximum grip

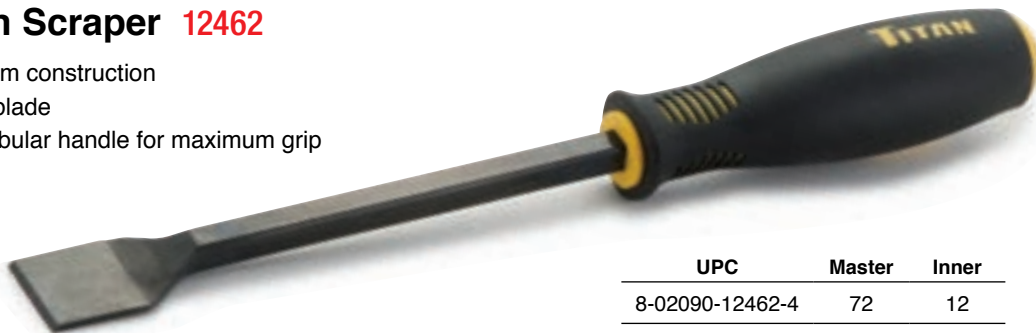

UPC	Master	Inner
8-02090-12462-4	72	12



4 pc. Nylon Scraper Set 11565

- Removes decals, emblems & body molding without scratching surface
- Durable design absorbs hammer blows
- Edges can be re-sharpened
- Sizes Includes 3/4, 7/8, 1/2, 1-1/2"

UPC	Master	Inner
8-02090-11565-3	12	6

4 pc. Pry Bar Set 17009

- Sizes include: (1) 5-1/2 x 7/8", (1) 7-1/4 x 9/16", (1) 9-1/4 x 9/16" & (1) 12" x 2"
- Rigid stainless steel construction with mirror polished finish
- Razor sharp scraper edges
- Ideal for nail & tack pulling, prying and scraping

UPC	Master	Inner
8-02090-17009-6	24	6



3 pc. Pry Bar Set 17007

- Sizes include: (1) 5-1/2 x 7/8", (1) 7-1/4 x 9/16", & (1) 9-1/4 x 9/16"
- Rigid stainless steel construction with mirror polished finish
- Razor sharp scraper edges
- Ideal for nail & tack pulling, prying and scraping

UPC	Master	Inner
8-02090-17007-2	24	6



2 pc. Stainless Steel Pry Bar/Scraper Set 17005

- Sizes include: (1) 7-1/4 x 9/16" & (1) 9-1/4 x 9/16"
- Rigid stainless steel construction with mirror polished finish
- Razor sharp scraper edges
- Ideal for nail & tack pulling, prying and scraping

UPC	Master	Inner
8-02090-17005-8	36	6



Multi-Purpose Pry Bar 11513

- Overall Size: 9" x 1-1/2"
- Rigid stainless steel construction with mirror polished finish
- Razor sharp scraper edges
- Ideal for nail & tack pulling, prying and scraping

UPC	Master	Inner
8-02090-11513-4	48	6



1-1/4 in. Flexible Scraper 12025

- Semi-flexible steel blade
- Easy to clean handle with hang hole for storage



UPC	Master	Inner
8-02090-12025-1	144	12

3 in. Flexible Scraper 12503

- Flexible stainless steel blade
- Comfortable TPR handle for maximum grip



UPC	Master	Inner
8-02090-12503-4	72	6

1-1/4 in. Flexible Scraper 12501

- Flexible stainless steel blade
- Comfortable TPR handle for maximum grip



UPC	Master	Inner
8-02090-12501-0	72	6

1-1/4 in. Stainless Steel Scraper 12500

- Stainless Steel blade
- Comfortable TPR handle for maximum grip



UPC	Master	Inner
8-02090-12500-3	72	6

1-1/4 in. Offset Stainless Steel Scraper 12505

- Rigid stainless steel Go-Thru blade with metal capped handle for strength & durability
- Comfortable TPR handle for maximum grip
- Offset design for hard to reach areas



UPC	Master	Inner
8-02090-12505-8	48	6

Multi-Purpose Scraper 12600

- Stainless Steel blade
- Comfortable TPR handle for maximum grip
- 6-in-1 uses: Wall scraper, paint roller cleaner, paint remover, nail and tack remover, putty and grout remover, putty knife



UPC	Master	Inner
8-02090-12600-0	72	12

3 pc. Scraper and Putty Set 17000

- 1-1/4" Scraper - Rigid stainless steel Go-Thru blade with metal capped handle for strength & durability
- 1-1/4" and 3" Putty Knives - Flexible stainless steel blades for easier application of fillers and putties
- All tools feature comfortable TPR handles for maximum grip

UPC	Master	Inner
8-02090-17000-3	12	6



Multi-Purpose Razor Scraper 12030

- Ideal for scraping labels and decals from glass, windshields, etc.
- Comfortable TPR handle for maximum grip
- Includes one extra-heavy duty .020" razor blade - over twice as thick as a standard razor blade
- Uses Titan replacement blades 11039
- Accepts both standard and heavy duty razor blades



UPC	Master	Inner
8-02090-12030-5	36	6

Mini Razor Scraper 12031

- Tough polypropylene construction
- TPR comfort sleeve for better grip and more control
- Includes one extra-heavy duty .020" razor blade - over twice as thick as a standard razor blade
- Protective safety cap
- Uses Titan replacement blades 11036, 11038 or 11039



UPC	Master	Inner
8-02090-12031-2	72	12

2 pc. Multi-Purpose Razor Scraper Set 17002

- Set includes: (1) Multi-purpose razor scraper, (1) Mini razor scraper, (5) extra-heavy duty razor blades
- Ideal for scraping labels and decals from glass, windshields, etc
- Comfortable TPR handle for maximum grip
- Tough polypropylene construction
- Over twice as thick as a standard razor blade



UPC	Master	Inner
8-02090-17002-7	48	6

22 pc. Scraper Set 17008

- Set Includes: (11) 0.020" Razor Blades, (10) Non-Marring Scraper Blades, (1) 9" Razor Scraper
- Non-scratching/non-marring scraper blades are ideal for scraping finished surfaces
- 9" Razor scraper accepts standard single edge razor blades and non-marring blades



UPC	Master	Inner
8-02090-17008-9	48	6

3-Position Scraper 12029

- Effectively removes stickers, paint, tape and varnish from glass, porcelain and steel
- 3-position lock for use in different areas
- Blade folds under handle for safety and compact storage
- Uses Titan replacement blades 11036, 11038 or 11039

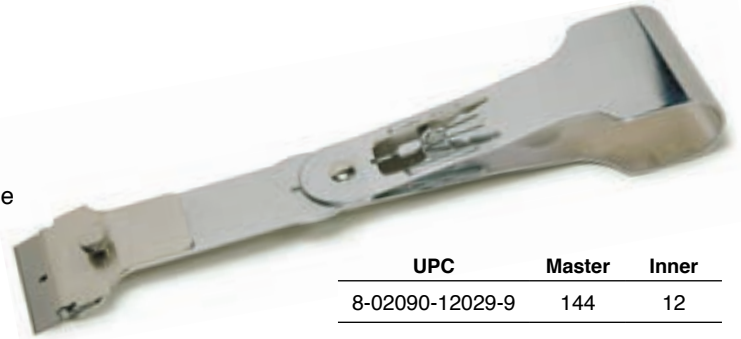

UPC	Master	Inner
8-02090-12029-9	144	12

100 pc. #9 Single Edge Razor Blades 11036

- #9 Blades - .009" thickness
- 100 pieces single edge razor blades
- Fits all standard razor blade tools
- Ships in reclosable clamshell



UPC	Master	Inner
8-02090-11036-8	48	6

100 pc. #12 Single Edge Razor Blades 11038

- #12 Blades - .012" thickness
- 100 pieces single edge razor blades
- Fits all standard razor blade tools
- Ships in reclosable clamshell



UPC	Master	Inner
8-02090-11038-2	48	6

21 pc. Non-Marring Scraper Blades 12038

- Ideal for scraping labels and decals from glass, windshields, etc.
- 2 Individual packs containing (10) Non-Marring Scraper Blades.
- Polymere Construction
- Fits most common scrapers
- Each blade features two usable edges



UPC	Master	Inner
8-02090-12038-1	36	6

21 pc. Heavy Duty Razor Blades 11039

- 20 pc Extra-Heavy Duty #20 Razor Blades
- Extra-heavy duty .020" thickness
- Ideal for scraping labels and decals from glass, windshields, etc.
- Over twice as thick as a standard razor blade
- These are replacement blades for Titan #11030 and #11031



UPC	Master	Inner
8-02090-11039-9	36	6

Folding Utility Knives

- Quick change blade requires no tools
- Folding lock for safety
- Easy carry belt clip
- Includes 5 extra blades in handy dispenser
- Ships bulk in 12 pc counter display



Part #	UPC	Master	Inner
11015 RED	8-02090-11015-3	48	12
11018 BLUE	8-02090-11015-3	48	12
11020 2-pc: 1-Red, 1-Blue	8-02090-11020-7	48	12

Sliding Utility Knife 11024

- Quick change blade mechanism
- Smooth retracting/locking blade advance
- TPR molded for better grip
- 4-1/2" closed, 6-7/8" fully open
- Color: yellow
- Use Titan #11034 replacement blades
- Includes 3 extra blades



UPC	Master	Inner
8-02090-11024-5	48	12

Readi-Blade Utility Knife 11026

- Never a dull blade! Slide knob back then forward to automatically load new blade
- Blade retracts for safety
- Heavy duty die cast body
- TPR Grips for comfort and positive grip
- Knife holds 10 extra blades

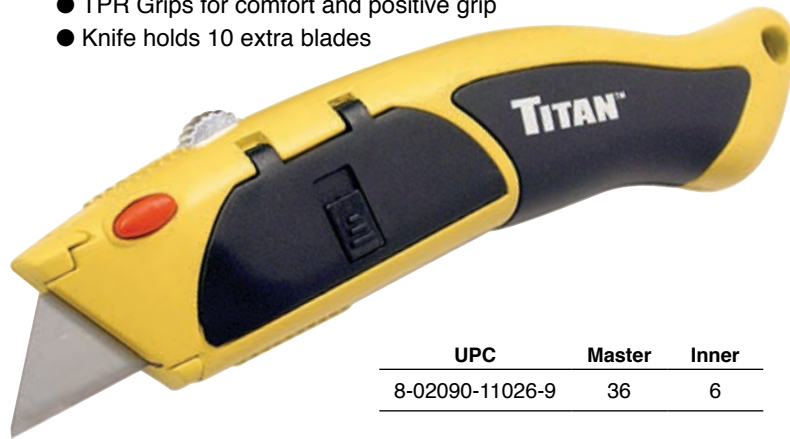

UPC	Master	Inner
8-02090-11026-9	36	6

10 pc. Standard Utility Knife Blades 11034

- Heavy duty blades
- Ideal for general purpose cutting
- Fits most standard utility knives including all Titan utility knives

UPC	Master	Inner
8-02090-11034-4	480	40



General Purpose Vises

- Replaceable serrated steel jaws
- Large built-in anvil
- Hardened steel jaws
- Replacement Jaw available
- Fixed-base (#22055, 22056, 22058)
- Swivel base with position lock (#22010, 22013, 22015, 22059)

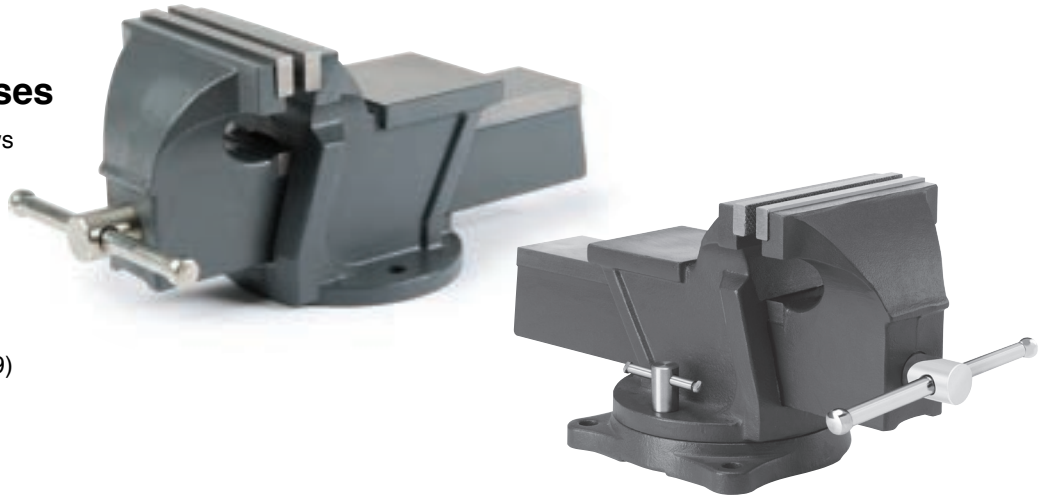

Part #	Jaw Width (in.)	Max Opening Capacity (in.)	Throat Depth (in.)	Weight (lbs.)	UPC	Master	Inner
Swivel-Base Vises							
22010	4	4-1/4	1.97"	12.95	8-02090-22010-4	1	1
22013	5	4	2.36"	21.7	8-02090-22013-5	1	1
22015	6	5	2.67	31.05	8-02090-22015-9	1	1
22059	10	8-7/8	4-1/4	134	8-02090-22059-3	1	1
Fixed-Base Vises							
22055	5	4	2-1/4	18.74	8-02090-22055-5	1	1
22056	6	5	2-5/8	26.50	8-02090-22056-2	1	1
22058	8	6	3-1/2	52.82	8-02090-22058-6	1	1

Industrial Utility Vises

- 180 ° locking swivel base with single lockdown
- Large built-in anvil
- Pipe jaws
- 4 mounting posts
- Replaceable serrated steel jaws



Part #	Jaw Width (in.)	Max Jaw Opening (in.)	Throat Depth (in.)	Pipe Capacity(in.)	Weight (lbs.)	UPC	Master	Inner
22011	4.5	4	2.6	0.53 - 2.36	18.65	8-02090-22011-1	1	1
22014	5.5	5	3.19	0.53 - 2.48	28.65	8-02090-22014-2	1	1
22016	6	6	3.82	0.53 - 3.46	39.25	8-02090-22016-6	1	1
22018	8	7.48	4.45	0.53 - 3.94	79.20	8-02090-22018-0	1	1

5 in. Multi-Purpose Vise 22012

- Hardened steel jaws rotate 360 degrees
- Jaws rotate for clamping at any angle
- Precision cast iron beam
- Replaceable jaws
- Incorporated anvil
- Replacement Jaw available: Item # 22005

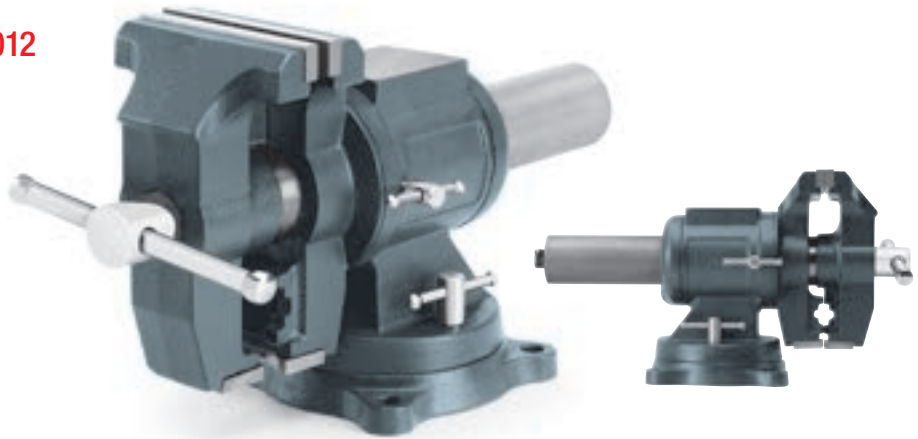

Jaw Width (in.)	Max Jaw Opening (in.)	Throat Depth (in.)	Pipe Capacity (in.)	Weight (lbs.)	UPC	Master	Inner
5	5	2.64	0.31 - 1.73	34.4	8-02090-22012-8	1	1

5 in. Quick-Release Swivel-Base Vise 22057

- Replaceable serrated steel jaws
- Quick-release mechanism
- Precision cast iron beam
- Swivel-base with locking positions
- Large built-in anvil



Jaw Width (in.)	Max Jaw Opening (in.)	Throat Depth (in.)	Weight (lbs.)	UPC	Master	Inner
5	7	2.67	20.9	8-02090-22057-9	1	1

Replacement Jaws

Part #	Jaw Width (in.)	Fits	UPC	Master	Inner
22003	4	22010 General Purpose	8-02090-22003-6	15	1
22006	5	22013 General Purpose	8-02090-22006-7	15	1
22008	6	22015 General Purpose	8-02090-22008-1	15	1
22004	4	22011 Industrial Utility	8-02090-22004-3	15	1
22007	5	22014 Industrial Utility	8-02090-22007-4	15	1
22009	6	22016 Industrial Utility	8-02090-22009-8	15	1
22005	5	22012 Multi-Purpose	8-02090-22005-0	15	1



2-1/2 in. Clamp-on Vise **22052**

- Dual jaw design includes (1) 2-1/2" knurled jaw and (1) 1-1/2" smooth jaw
- Replaceable hardened steel jaws
- Swivel base and swivel jaws rotate 360 degrees
- Clamps to bench or can be permanently mounted
- Built-in anvil

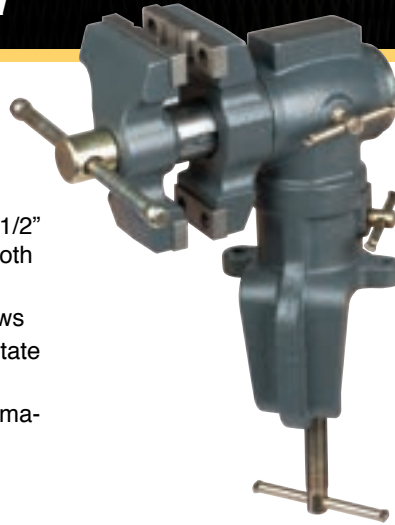

Jaw Width (in.)	Max Jaw Opening (in.)	Throat Depth (in.)	Weight (lbs.)	UPC	Master	Inner
2.5	2.28	1.34	8.25	8-02090-22052-4	1	1

3 in. Clamp-on Vise **22053**

- Hardened steel jaws
- Includes a mini serrated pipe jaw for holding round objects
- Clamps securely to the work bench



Jaw Width (in.)	Max Jaw Opening (in.)	Throat Depth (in.)	Weight (lbs.)	UPC	Master	Inner
3	2.5	1.55	4	8-02090-22053-1	1	1

Non-Marring Magnetic Vise Jaw Pads

- Knurled surface for enhanced grip
- Securely fastens to vise jaws with 2 strong magnets
- Non-Marring material prevents clamp marks, scratching and damage to finished surfaces

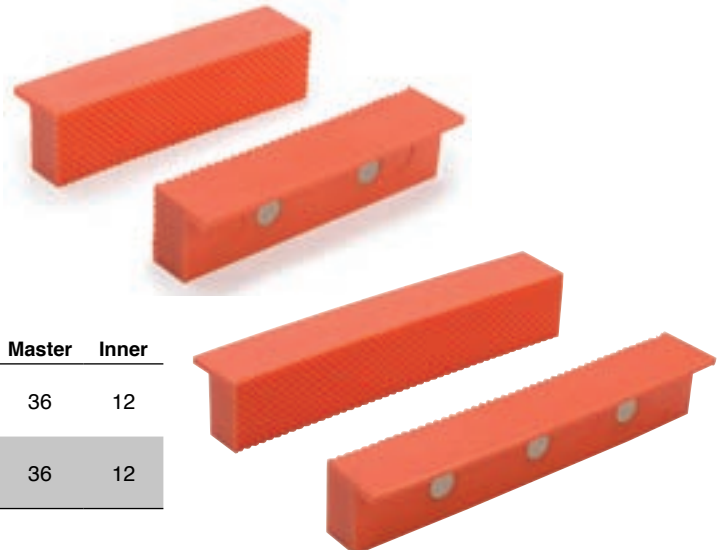

Part #	Jaw Width (in.)	Fits	UPC	Master	Inner
22019	4-1/2	3-4-1/2 in. Vise	8-02090-22019-7	36	12
22020	6	3-6 in. Vise	8-02090-22020-3	36	12

Heavy Duty C-Clamps

- Malleable steel with a durable black enamel finish



Item#	Opening Capacity (in.)	Throat Depth (in.)	Clamp Pressure (lbs.)	Spindle Size (in.)	Net Weight (lbs.)	UPC	Inner	Master
51912	2	13/16	265	0.315	0.31	8-02090-51912-3	100	50
51572	3	2	787	2-11/64	1.29	8-02090-51572-9	24	6
51573	4	2-1/4	1349	3-31/64	1.80	8-02090-51573-6	12	6
51574	5	2-1/2	1573	4-5/32	2.66	8-02090-51574-3	12	6
51575	6	2-3/4	1573	4-5/32	2.85	8-02090-51575-0	12	6
51578	8	3-1/2	1573	4-5/32	4.30	8-02090-51578-1	10	2
51580	10	3-1/2	2248	4-5/32	5.77	8-02090-51580-4	6	1
51582	12	3-3/4	2248	4-5/32	7.17	8-02090-51582-8	6	1

TITAN

5 pc. 90 Tooth Ratchet Set 12175



- 4-Degree sweep
- Reversible
- Anodized aluminum handle
- Rebuild kits available
- Set Includes: (3) Sealed Head Ratchets: 1/4 in. dr. x 6 in., 3/8 in. dr. x 12 in. & 1/2 in. dr. x 16 in., (2) Swivel Head Ratchets: 1/4 in. dr. x 6-1/2 in. & 3/8 in. dr. x 10 in.



UPC	Master	Inner
8-02090-12175-3	10	1

3 pc. Quick-Release Offset Ratchet Set 18025

- Quick release feature holds sockets when you want them - lets go when you don't
- Offset design for hard-to-reach fasteners
- Contoured cushion grip handles
- Chrome vanadium steel construction
- 1/4" Dr x 5-1/2", 3/8" Dr x 8" & 1/2" Dr x 10"



UPC	Master	Inner
8-02090-18025-5	12	3

3 pc. Extra-Long Ratchet Set 11088

- Less than 10 degree sweep for use in tight spots
- Extra long design for easier access to confined areas
- Push button quick release design
- Chrome vanadium steel
- Includes 1/2", 3/8", & 1/4" Drive



UPC	Master	Inner
8-02090-11088-7	8	4

3 pc. Extra-Long Flex-Head Ratchet Set 11303

- 72 Tooth Ratchet Design
- Chrome vanadium steel construction
- Extra long flex head design for hard to reach fasteners
- TPR comfort grip handle



UPC	Master	Inner
8-02090-11303-1	8	4

3 pc. Extra-Long Ratchet Set 11307

- 72 Tooth Ratchet Design
- Chrome vanadium steel construction
- Extra long design for easier access in hard-to-reach areas
- TPR comfort grip handle



UPC	Master	Inner
8-02090-11307-9	8	4

2 pc. 1/4 in. and 3/8 in. Drive Gearless Micro Ratchet 18202

- Chrome molybdenum steel construction
- 1/4" Dr x 2-7/8" & 3/8" Dr x 4"



UPC	Master	Inner
8-02090-18202-0	48	6

1/4 in. and 3/8in Drive Mini Ratchet 12103

- 1/4" & 3/8" drive sockets
- Compact handle for confined areas
- Knurled handle for better grip
- Overall length: 3"



UPC	Master	Inner
8-02090-12103-6	48	6

2 pc. Micro Bit Driver and Ratchet Set 11202

- 60 tooth gearhead design
- High torque Reversible
- Chrome Vanadium Construction
- Chrome plated polish helps prevent corrosion and rust
- Overall length: 3"



UPC	Master	Inner
8-02090-11202-7	48	6

2 pc. Offset Micro Bit Driver and Ratchet Set 11203

- 60 tooth gearhead design
- High torque Reversible
- Chrome Vanadium Construction
- Chrome plated polish helps prevent corrosion and rust
- Overall length: 3-1/2"



UPC	Master	Inner
8-02090-11203-4	48	6

10 pc. Accessory Set 18179

- 1/4" & 1/2" & 3/8" Universal Joints
- (4) 3/8" DR. Extensions : 1-1/2" 3" 6" & 10"
- 1/2" x 3/8" Reducer
- 3/8" x 1/4" Reducer
- 1/4" x 3/8" Adapter

UPC	Master	Inner
8-02090-18179-5	24	6



4 pc. 2-Way Extension Set 12098



- Knurled for better grip
- Sizes include: 1/4" Dr x 4", 3/8" Dr x 3", 3/8" Dr x 6" & 1/2" Dr x 5"

UPC	Master	Inner
8-02090-12098-5	48	12

3 pc. Wobble Extension Set 16105

- Drive sizes include: 1/4, 3/8, & 1/2"
- 2" overall length
- Chrome vanadium construction
- Mirror polish finish



UPC	Master	Inner
8-02090-16105-6	72	12

4 pc. Socket Adapter Set 16104

- Sizes include: 3/8"F x 1/4"M; 1/4"F x 3/8"M; 3/8"F x 1/2"M; & 1/2"F x 3/8"M
- Includes aluminum storage rail



UPC	Master	Inner
8-02090-16104-9	24	6

4 pc. Socket Adapter Set 60934

- Sizes include: 1/4" Dr (F) to 3/8" Dr (M), 3/8" Dr (F) to 1/4" Dr (M), 1/2" Dr (F) to 3/8" Dr (M) & 3/8" Dr (F) to 1/2" Dr (M)
- Chrome vanadium construction
- Mirror polish finish



UPC	Master	Inner
8-02090-60934-3	48	6

3 pc. Universal Joint Set 60933

- Chrome vanadium construction
- Mirror polish finish
- Sizes include: 1/4", 3/8" & 1/2" drive



UPC	Master	Inner
8-02090-60933-6	48	6

3 pc. Socket Adapter Set 66156

- Chrome vanadium construction
- Knurled ring around socket adapter base allowing for a secure grip in greasy or oily conditions
- Mirror polish finish



UPC	Master	Inner
8-02090-66156-3	48	6

7 pc. Adapter and Universal Joint Set 17407

- Adapter sizes: 1/4"F to 3/8"M, 3/8"F to 1/4"M, 3/8"F to 1/2"M, 1/2"F to 3/8"M
- U-Joint sizes: 1/4, 3/8, & 1/2"

UPC	Master	Inner
8-02090-17407-0	36	6



7 pc. Adapter and Universal Joint Set 17408

- Adapter sizes: 1/4"F to 3/8"M, 3/8"F to 1/4"M, 3/8"F to 1/2"M, 1/2"F to 3/8"M
- U-Joint sizes: 1/4, 3/8, & 1/2"

UPC	Master	Inner
8-02090-17408-7	36	6



1/4 in. Drive Extensions

- Knurled ring around extension base allowing for a secure grip in greasy or oily conditions
- Chrome vanadium construction
- Mirror polish finish

Part #	Size (in.)	UPC	Master	Inner
66940 3-pc	2, 4 & 6	8-02090-66940-8	48	6
66142	2.	8-02090-66142-6	48	6
66144	4	8-02090-66144-0	48	6
66146	6	8-02090-66146-4	48	6



1/4 in. F x 3/8 in. M Drive Increasing Adapter **66157**

- Mirror polish finish

UPC	Master	Inner
8-02090-66157-0	48	6



1/4 in. Drive Universal Joint **66130**

- Chrome vanadium construction
- Mirror polish finish
- Knurled ring around u-joint base allowing for a secure grip in greasy or oily conditions

UPC	Master	Inner
8-02090-66130-3	48	6



1/4 in. Drive 6-1/2 in. Swivel Head Ratchet **12167**

- 90 Tooth mechanism
- 4-Degree Sweep
- Anodized Aluminum Handle
- Quick Release
- Overall length: 6-1/2"
- Rebuild kit available, part # 12172

UPC	Master	Inner
8-02090-12167-8	48	6



1/4 in. Drive 6 in. Ratchet **12160**

- 90 Tooth mechanism
- 4-Degree Sweep
- Anodized Aluminum Handle
- Overall length: 6"
- Rebuild kit available, part # 12172

UPC	Master	Inner
8-02090-12160-9	96	24



1/4 in. Drive 12 in. Extra-Long Flex-Head Ratchet 11300

- Overall Length: 12"
- 72 tooth ratchet design
- Extra long flex head design for hard to reach fasteners
- TPR comfort grip handle
- Rebuild kit part # 11308



UPC	Master	Inner
8-02090-11300-0	48	12

1/4 in. Drive 12 in. Extra-Long Ratchet 11304

- Overall Length: 12"
- 73 tooth ratchet design
- Extra long flex head design for hard to reach fasteners
- TPR comfort grip handle



UPC	Master	Inner
8-02090-11304-8	48	12

1/4 in. Drive Extendable Ratchet 12075

- Telescopes from 6" - 8" (152-203mm) in 3 increments
- Quick release feature
- Contoured cushion grip handle
- 72 Tooth Ratchet Mechanism



UPC	Master	Inner
8-02090-12075-6	48	6

1/4 in. Drive Offset Ratchet 12042

- Contoured cushion grip handle
- Offset design for hard-to-reach fasteners
- 72 Tooth gear drive ratchet mechanism engages with just 5 degrees of swing to work in the tightest spaces
- Chrome vanadium steel construction
- Overall Length: 5-3/4"

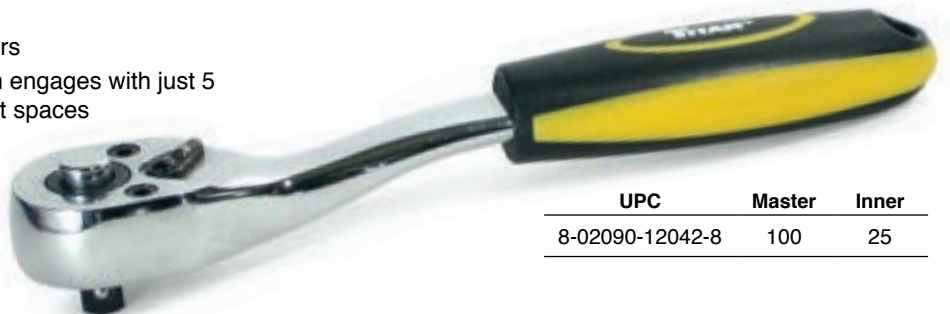

UPC	Master	Inner
8-02090-12042-8	100	25

1/4 in. Drive Teardrop Ratchet 66101

- Quick release teardrop ratchet
- Smooth ratcheting action
- Rugged and durable construction help make tough jobs easier
- Chrome vanadium construction
- Mirror polish finish
- Overall Length: 5-5/8"

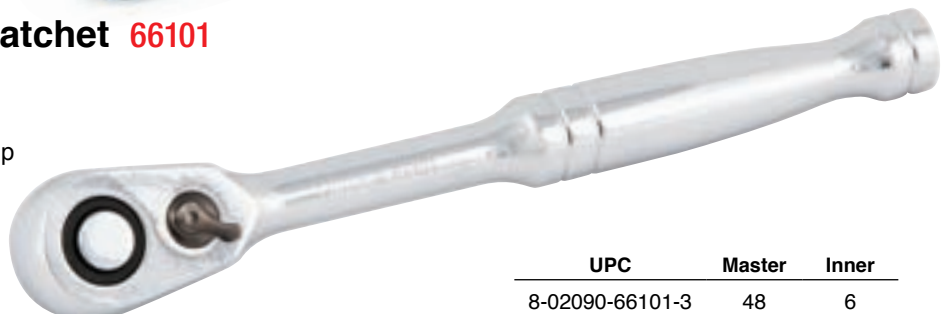

UPC	Master	Inner
8-02090-66101-3	48	6

1/4 in. Drive Finger Ratchet 12090

- Reversible ratchet
- Designed to reach confined spaces



UPC	Master	Inner
8-02090-12090-9	96	12

1/4 in. Drive 3 in. Mini Ratchet 12101

- Compact handle for confined areas
- Knurled handle for better grip
- Overall Length: 3"



UPC	Master	Inner
8-02090-12101-2	96	6

1/4 in. Drive Offset Micro Ratchet 11204

- 60 tooth gear head design
- High torque
- Offset handle gets into the most confined areas
- Overall length: 3-1/2"



UPC	Master	Inner
8-02090-11204-1	48	6

1/4 in. Drive Gearless Micro Ratchet 11200

- Chrome-Molybdenum Steel
- Overall length: 3"

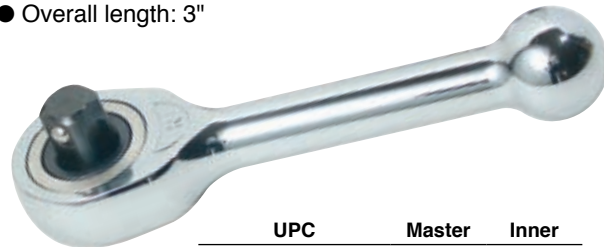

UPC	Master	Inner
8-02090-11200-3	36	6

Offset Micro Bit Driver With Bits 11205

- Ideal for confined under-dash and engine compartment spaces
- Chrome plated polish helps prevent corrosion and rust
- 1/4" Drive
- Chrome Vanadium
- Contains: PH1, PH2, PH2, Slotted 1/4", Slotted 3/16"
- T-15, T-20, R1, R2
- Bit Driver: 43ft/lbs of torque
- Overall ratchet length: 3-1/2"



UPC	Master	Inner
8-02090-11205-8	48	6

10 pc. Micro Flex Bit Driver 11212

- Chrome plated polish prevents corrosion & rust
- Set Includes:
 - (3) Phillips: #1, #2, #2
 - (2) Slotted: 3/16" & 1/4"
 - (2) Star: T-15 & T-20
 - (2) Square: R1 & R2
- Convenient bit holder
- Overall ratchet length: 4-1/8"



UPC	Master	Inner
8-02090-11212-6	48	6

1/4 in. Drive Stubby Ratchet 66113

- Quick release stubby ratchet
- Smooth ratcheting action
- Rugged and durable construction help make tough jobs easier
- Chrome vanadium construction
- Mirror polish finish
- Overall Length: 3-5/8"

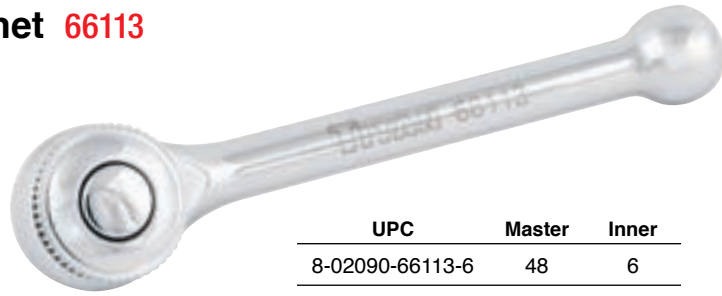

UPC	Master	Inner
8-02090-66113-6	48	6

1/4 in. Drive Swivel Head Ratchet 11066

- 72 tooth ratchet mechanism
- Chrome vanadium steel construction
- Overall length: 5-5/8"



UPC	Master	Inner
8-02090-11066-5	48	6

21 pc. 1/4 in. Drive Socket Sets

- Knurling on sockets & extensions for additional grip
- 5" Slim Head Quick Release Ratchet with 6° sweep
- Includes 6" Spinner Handle, 2" & 6" Extensions, Universal Joint & Storage carry case



Part #	Socket Sizes	UPC	Master	Inner
66001 SAE	6 Point Std Sockets- 3/16, 7/32, 1/4, 9/32, 5/16, 11/32, 3/8, 7/16 & 1/2"	8-02090-66001-6	20	2
	6 Point Deep Sockets: 1/4, 9/32, 5/16, 11/32, 3/8, 7/16 & 1/2"			
66201 MM	6 Point Std Sockets- 4,5,6,7,8,9,10 11 & 12mm	8-02090-66201-0	20	2
	6 Point Deep Sockets- 4,5,6,7,8,9,10,11 & 12mm			



10 pc. 1/4 in. Drive Standard 6pt. Socket Sets

- Durable, precise fitting sockets
- Sizes stamped for easy identification
- Knurled ring around socket base allowing for a secure grip in greasy or oily conditions
- Chrome vanadium steel construction
- Mirror polish finish



Part #	Socket Sizes	UPC	Master	Inner
66002 SAE	5/32, 3/16, 7/32, 1/4, 9/32, 5/16, 11/32, 3/8, 7/16 and 1/2 inch	8-02090-66002-3	24	6
66202 MM	4, 5, 6, 7, 8, 9, 10, 11, 12 & 13 mm	8-02090-66202-7	24	6

10 pc. 1/4 in. Drive Deep 6pt. Socket Sets

- Durable, precise fitting sockets
- Sizes stamped for easy identification
- Knurled ring around socket base allowing for a secure grip in greasy or oily conditions
- Chrome vanadium steel construction
- Mirror polish finish



Part #	Socket Sizes	UPC	Master	Inner
66300 SAE	5/32, 3/16, 7/32, 1/4, 9/32, 5/16, 11/32, 3/8, 7/16 & 1/2 inch	8-02090-66300-0	24	6
66400 MM	4, 5, 6, 7, 8, 9, 10, 11, 12 & 13 mm	8-02090-66400-7	24	6

3/8 in. Drive Swivel Head Ratchets

- 72 tooth ratchet mechanism
- Chrome vanadium steel construction



Part #	Length (in.)	UPC	Master	Inner
11067	5-5/8	8-02090-11067-2	48	6
11076	8-3/4	8-02090-11076-4	48	6

3/8 in. Drive 18 in. Extra-Long Flex-Head Ratchet 11301

- Overall Length: 18"
- 36 tooth ratchet design
- Extra long flex head design for hard to reach fasteners
- Chrome vanadium steel construction
- TPR comfort grip handle
- Rebuild kit part # 11309



UPC	Master	Inner
8-02090-11301-7	24	6

3/8 in. Drive 18 in. Extra-Long Ratchet 11305

- Overall Length: 18"
- 37 tooth ratchet design
- Extra long design for hard to reach fasteners
- Chrome vanadium steel construction
- TPR comfort grip handle
- Rebuild kit part # 11309



UPC	Master	Inner
8-02090-11305-5	24	6

3/8 in. Drive Extendable Ratchet 12070

- Telescopes from 8-12" (215-315mm) in 4 increments
- Quick release feature
- Contoured cushion grip handle
- 72 Tooth Ratchet Mechanism

UPC	Master	Inner
8-02090-12070-1	48	6



3/8 in. Drive 12 in. Sealed Head Ratchet 12161

- Overall length: 12"
- 4-Degree Sweep
- Reversible
- Anodized Aluminum Handle
- Rebuild kit part # 12170



UPC	Master	Inner
8-02090-12161-6	48	12

3/8 in. Drive 10 in. Swivel Head Ratchet 12168

- Overall length: 10"
- 4-Degree Sweep
- Quick Release
- Anodized Aluminum Handle
- Rebuild kit part # 12173



UPC	Master	Inner
8-02090-12168-5	48	6

3/8 in. Drive Teardrop Ratchet 68101

- Quick release teardrop ratchet
- Smooth ratcheting action
- Rugged and durable construction help make tough jobs easier
- Chrome vanadium construction
- Mirror polish finish
- Overall Length: 7-3/4"



UPC	Master	Inner
8-02090-68101-1	24	6

3/8 in. Drive Teardrop Flex Ratchet 68102

- Quick release flex head ratchet
- Smooth ratcheting action
- Rugged and durable construction help make tough jobs easier
- Chrome vanadium construction
- Overall Length: 11-1/2"

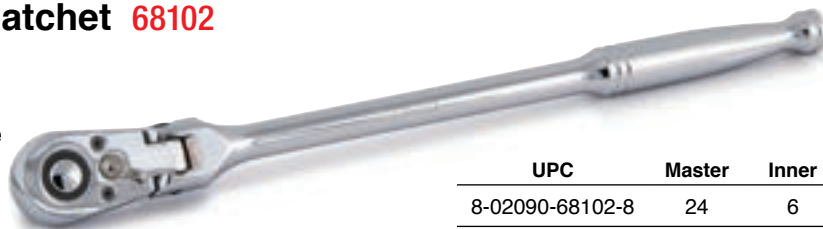

UPC	Master	Inner
8-02090-68102-8	24	6

3/8 in. Drive Quick-Release Round Head Ratchet 68107

- Quick release round head ratchet
- Smooth ratcheting action
- Rugged and durable construction help make tough jobs easier
- Chrome vanadium construction
- Overall Length: 7-3/4"



UPC	Master	Inner
8-02090-68107-3	24	6

3/8 in. Drive Offset Ratchet 12043

- Contoured cushion grip handle
- Offset design for hard-to-reach fasteners
- 72 Tooth gear drive ratchet mechanism engages with just 5 degrees of swing to work in the tightest spaces
- Chrome vanadium steel construction
- Overall Length: 8"

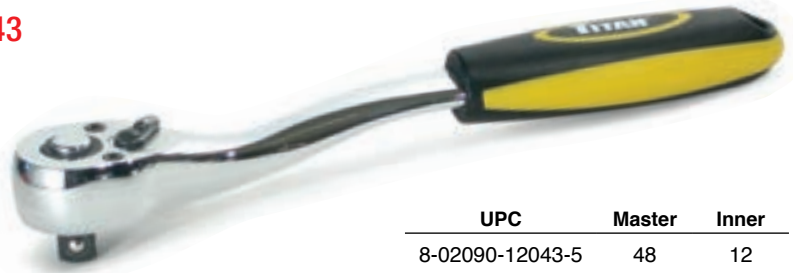

UPC	Master	Inner
8-02090-12043-5	48	12

3/8 in. Drive Offset Extra-Long Ratchet 12045

- 36-tooth gear-drive ratchet mechanism for high torque applications
- Quick-release feature holds sockets when you want them, lets go when you don't
- Contoured cushion grip handle
- Overall Length: 9-1/2"

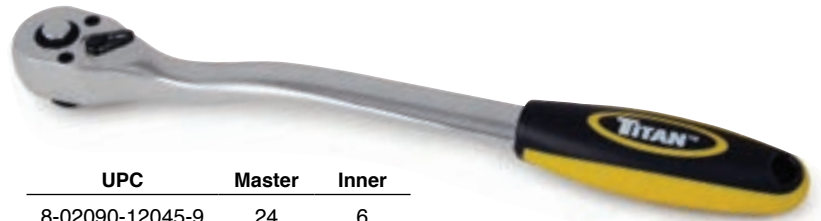

UPC	Master	Inner
8-02090-12045-9	24	6

1/4 in. and 3/8 in. Drive Offset Ratchet 12052

- 72 tooth ratchet mechanism engages with just 5 degrees of sweep for work in the tightest spaces
- Contoured cushion grip handle
- Overall Length: 8"

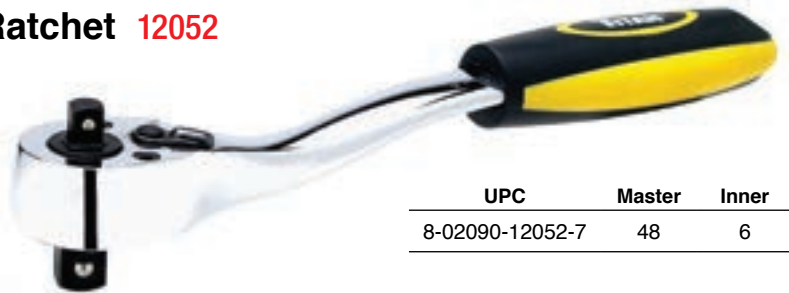

UPC	Master	Inner
8-02090-12052-7	48	6

1/4 in. and 3/8 in. Drive Stubby Ratchet 12050

- 72 tooth ratchet mechanism engages with just 5 degrees of sweep for work in the tightest spaces
- Contoured cushion grip handle

UPC	Master	Inner
8-02090-12050-3	48	6



1/4 in. and 3/8 in. Drive Flex Head Stubby Ratchet 12350

- 72 tooth ratchet mechanism engages with just 5 degrees of sweep for work in the tightest spaces
- Contoured cushion grip handle

UPC	Master	Inner
8-02090-12350-4	48	6



1/4 in. and 3/8 in. Drive Flex-Head Ratchet 12357

- 72 tooth ratchet mechanism engages with just 5 degrees of sweep for work in the tightest spaces
- Contoured cushion grip handle
- Overall Length: 9-1/2"

UPC	Master	Inner
8-02090-12357-3	48	6



3/8 in. and 1/2 in. Drive Flex Ratchet 12358

- 72 tooth ratchet mechanism engages with just 5 degrees of sweep for work in the tightest spaces
- Contoured cushion grip handle
- Overall Length: 9-1/2"

UPC	Master	Inner
8-02090-12358-0	48	6



3/8 in. Drive Round Stubby Ratchet 68112

- Overall length: 4-5/8"
- Quick release round head ratchet
- Smooth ratcheting action
- Rugged and durable construction help make tough jobs easier
- Mirror polish finish



UPC	Master	Inner
8-02090-68112-7	48	6

3/8 in. Drive Finger Ratchet 12091

- Reversible ratchet
- For use confined spaces



UPC	Master	Inner
8-02090-12091-6	96	12

3/8 in. Drive 3 in. Mini Ratchet 12102

- Compact handle for confined areas
- Knurled handle for better grip
- Overall Length: 3"



UPC	Master	Inner
8-02090-12102-9	48	6

3/8 in. Drive Gearless Micro Ratchet 11201

- Chrome molybdenum steel construction
- U.S. Patent
- Overall Length: 4"



UPC	Master	Inner
8-02090-11201-0	36	6

3/8 in. Drive Breaker Bars

- Heavy duty chrome vanadium steel construction
- Maximum torque: 100 ft-lbs (14 kg/m)
- Chrome plated bar and black oxide finish head to resist corrosion



Part #	Size (in.)	UPC	Master	Inner
68118	10	8-02090-68118-9	48	6
12019	18	8-02090-12019-0	24	6

3/8 in. Drive 15 in. Ratcheting Breaker Bar 12015

- 3/8" drive ratchet head swivels 180°
- Heavy duty chrome vanadium steel construction
- Maximum torque: 148 ft/lbs (20 kg/m)
- 3-way ratcheting action: right-hand thread, left-hand thread or lock
- Chrome plated bar and black oxide finish head to resist corrosion
- REPLACEMENT HEAD available: #12027



UPC	Master	Inner
8-02090-12015-2	12	3

3/8 in. Drive U Joint 68130

- Chrome vanadium construction
- Mirror polish finish
- Knurled ring around u-joint base allowing for a secure grip in greasy or oily conditions



UPC	Master	Inner
8-02090-68130-1	48	6

3/8 in. F Drive Adapters



Part #	Size (in.)	UPC	Master	Inner
68158	3/8 F x 1/2 M	8-02090-68158-5	48	6
68159	3/8 F x 1/4 M	8-02090-68159-2	120	12

3/8 in. Drive Extensions

Part #	Size (in.)	UPC	Master	Inner
68140	1-3/4	8-02090-68140-0	48	6
68143	3	8-02090-68143-1	48	6
68146	6	8-02090-68146-2	48	6
68148	8	8-02090-68148-6	48	6
68150	10	8-02090-68150-9	48	6
68156	18	8-02090-68156-1	48	6



4 pc. 3/8 in. Drive Extension Set **68152**

- Lengths included: 1-3/4, 3, 6 & 8"
- Knurled ring around extension base allowing for a secure grip in greasy or oily conditions
- Chrome vanadium construction
- Mirror polish finish

UPC	Master	Inner
8-02090-68152-3	48	6

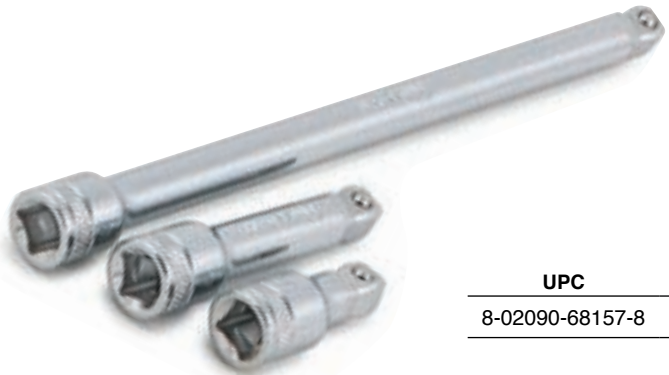

3 pc. 3/8 in. Drive Wobble Ext Set **68157**

- Lengths included: 1-3/4, 3, & 8"
- Knurled ring around extension base allowing for a secure grip in greasy or oily conditions
- Chrome vanadium construction
- Mirror polish finish

UPC	Master	Inner
8-02090-68157-8	24	6

3 pc. 3/8 in. Drive Extra-Long Extension Set **12079**

- Sizes include: 18, 24, & 30"
- Extra long extension for easy access in confined areas
- Chrome plated to resist corrosion



UPC	Master	Inner
8-02090-12079-4	12	6

3/8 in. Drive SAE Standard 6 pt. Sockets

- Sizes stamped for easy identification
- Knurled ring around socket base allowing for a secure grip in greasy or oily conditions
- Chrome vanadium steel construction
- Mirror polish finish



Part #	Size (in.)	UPC	Master	Inner
68008	1/4	8-02090-68008-3	48	6
68010	5/16	8-02090-68010-6	48	6
68012	3/8	8-02090-68012-0	48	6
68014	7/16	8-02090-68014-4	48	6
68016	1/2	8-02090-68016-8	48	6
68018	9/16	8-02090-68018-2	48	6
68020	5/8	8-02090-68020-5	48	6
68022	11/16	8-02090-68022-9	48	6
68024	3/4	8-02090-68024-3	48	6
68026	13/16	8-02090-68026-7	48	6
68028	7/8	8-02090-68028-1	48	6
68030	15/16	8-02090-68030-4	48	6
68032	1	8-02090-68032-8	48	6

3/8 in. Drive Metric Standard 6 pt. Sockets

- Sizes stamped for easy identification
- Knurled ring around socket base allowing for a secure grip in greasy or oily conditions
- Chrome vanadium steel construction
- Mirror polish finish



Part #	Size (mm)	UPC	Master	Inner
68206	6	8-02090-68206-3	48	6
68207	7	8-02090-68207-0	48	6
68208	8	8-02090-68208-7	48	6
68209	9	8-02090-68209-4	48	6
68210	10	8-02090-68210-0	48	6
68211	11	8-02090-68211-7	48	6
68212	12	8-02090-68212-4	48	6
68213	13	8-02090-68213-1	48	6
68214	14	8-02090-68214-8	48	6
68215	15	8-02090-68215-5	48	6
68216	16	8-02090-68216-2	48	6
68217	17	8-02090-68217-9	48	6
68218	18	8-02090-68218-6	48	6
68219	19	8-02090-68219-3	48	6
68220	20	8-02090-68220-9	48	6
68221	21	8-02090-68221-6	48	6
68222	22	8-02090-68222-3	48	6

3/8 in. Drive Spark Plug Sockets

- Size stamped for easy identification
- Knurled ring around socket base allowing for a secure grip in greasy or oily conditions
- Chrome vanadium construction



Part #	Size (in.)	UPC	Master	Inner
68160	5/8	8-02090-68160-8	48	6
68163	3/4	8-02090-68163-9	48	6
68170	9/16	8-02090-68170-7	48	6
68164	13/16	8-02090-68164-6	48	6

Part #	Size (mm)	UPC	Master	Inner
68166	14	8-02090-68166-0	48	6
68168	18	8-02090-68168-4	48	6



3/8 in Drive SAE Deep 6 pt. Sockets

- Sizes stamped for easy identification
- Knurled ring around socket base allowing for a secure grip in greasy or oily conditions
- Chrome vanadium steel construction
- Mirror polish finish

Part #	Size (in.)	UPC	Master	Inner
68308	1/4	8-02090-68308-4	48	6
68310	5/16	8-02090-68310-7	48	6
68312	3/8	8-02090-68312-1	48	6
68314	7/16	8-02090-68314-5	48	6
68316	1/2	8-02090-68316-9	48	6
68318	9/16	8-02090-68318-3	48	6
68320	5/8	8-02090-68320-6	48	6

Part #	Size (in.)	UPC	Master	Inner
68322	11/16	8-02090-68322-0	48	6
68324	3/4	8-02090-68324-4	48	6
68326	13/16	8-02090-68326-8	48	6
68328	7/8	8-02090-68328-2	48	6
68330	15/16	8-02090-68330-5	48	6
68332	1	8-02090-68332-9	48	6

3/8 in Drive Metric Deep 6 pt. Sockets

- Sizes stamped for easy identification
- Knurled ring around socket base allowing for a secure grip in greasy or oily conditions
- Chrome vanadium steel construction
- Mirror polish finish



Part #	Size (mm)	UPC	Master	Inner
68406	6	8-02090-68406-7	48	6
68407	7	8-02090-68407-4	48	6
68408	8	8-02090-68408-1	48	6
68409	9	8-02090-68409-8	48	6
68410	10	8-02090-68410-4	48	6
68411	11	8-02090-68411-1	48	6
68412	12	8-02090-68412-8	48	6
68413	13	8-02090-68413-5	48	6

Part #	Size (mm)	UPC	Master	Inner
68414	14	8-02090-68414-2	48	6
68415	15	8-02090-68415-9	48	6
68416	16	8-02090-68416-6	48	6
68417	17	8-02090-68417-3	48	6
68418	18	8-02090-68418-0	48	6
68419	19	8-02090-68419-7	48	6
68421	21	8-02090-68421-0	48	6
68422	22	8-02090-68422-7	48	6



5/8 in. 3/8 in. Drive Extension Spark Plug Socket **68162**

- 5" length
- Knurled ring around socket base allowing for a secure grip in greasy or oily conditions
- Size stamped for easy identification
- Chrome vanadium construction
- Mirror polish finish

UPC	Master	Inner
8-02090-68162-2	48	6

3/8 in. Drive Universal Joint Spark Plug Sockets

- Knurled ring around socket base allowing for a secure grip in greasy or oily conditions
- Size stamped for easy identification
- Chrome vanadium construction
- Mirror polish finish



Part #	Size (in.)	UPC	Master	Inner
68161	5/8	8-02090-68161-5	48	6
68165	13/16	8-02090-68165-3	48	6

3/8 in. Drive 10 in. Swivel Magnetic Extension Spark Plug Sockets

- Overall length: 10in
- Magnetic plug retainer
- CRV construction
- Knurled shaft for better grip

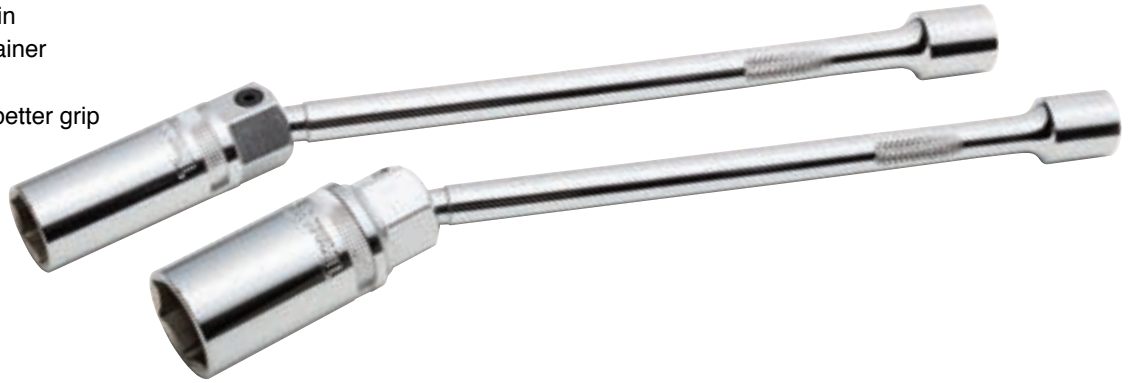

Part #	Size (in.)	UPC	Master	Inner
62161	5/8	8-02090-62161-1	24	6
62162	13/16	8-02090-62162-8	24	6

21 pc. 3/8 in. Drive SAE Socket Set 68001

- Set includes: (1) 7-3/4 inch slim head quick-release Ratchet with 6° sweep, (2) Extensions, sizes: 1-3/4 and 6 inch, (18) 6 point sockets, standard and deep sizes include: Standard 6 point sockets: 1/4, 5/16, 3/8, 7/16, 1/2, 9/16, 5/8, 11/16, and 3/4 inch, Deep 6 point sockets: 3/8, 7/16, 1/2, 9/16, 5/8, 11/16, 3/4, 13/16 and 7/8 inch
- Includes metal storage case
- Knurled texture around sockets and extensions for superior grip

UPC	Master	Inner
8-02090-68001-4	8	2



22 pc. 3/8 in. Drive Metric Socket Set 68201

- Set includes: (1) 7-3/4 inch slim head quick-release ratchet with 6° sweep, (2) Extensions, sizes: 3 and 6 inch, (1) 5/8 in. spark plug socket, (18) 6 point sockets, standard and deep sizes included: Standard 6 point sockets: 10, 11, 12, 13, 14, 15, 16, 17, 18, and 19 mm Deep 6 point sockets: 10, 11, 12, 13, 14, 15, 17 and 19 mm
- Knurled texture around sockets and extensions for superior grip
- Includes metal storage case

UPC	Master	Inner
8-02090-68201-8	8	2



10 pc. 3/8 in. Drive 6pt. Standard Socket Sets

- Durable, precise fitting socket
- Sizes stamped for easy identification
- Knurled ring around socket base allowing for a secure grip in greasy or oily conditions
- Chrome vanadium steel construction
- Mirror polish finish



Part #	Socket Sizes	UPC	Master	Inner
68002 SAE	1/4, 5/16, 3/8, 7/16, 1/2, 9/16, 5/8, 11/16, 3/4 & 13/16"	8-02090-68002-1	24	6
68202 MM	10, 11, 12, 13, 14, 15, 16, 17, 18 & 19mm	8-02090-68202-5	24	6

3/8 in. Drive 6 pt. Deep Socket Sets

- Durable, precise fitting sockets
- Sizes stamped for easy identification
- Knurled ring around socket base allowing for a secure grip in greasy or oily conditions
- Chrome vanadium steel construction
- Mirror polish finish



Part #	Socket Sizes	UPC	Master	Inner
68300 SAE	1/4, 5/16, 3/8, 7/16, 1/2, 9/16, 5/8, 11/16, 3/4 & 13/16"	8-02090-68300-8	12	6
68402 MM	10, 11, 12, 13, 14, 15, 16, 17, 18 & 19mm	8-02090-68402-9	24	6

10 pc. 3/8 in. Drive 12 pt. Standard Socket Sets

- Durable, precise fitting sockets
- Sizes stamped for easy identification
- Knurled ring around socket base allowing for a secure grip in greasy or oily conditions
- Chrome vanadium steel construction
- Mirror polish finish



Part #	Socket Sizes	UPC	Master	Inner
68500 SAE	1/4, 5/16, 3/8, 7/16, 1/2, 9/16, 5/8, 11/16, 3/4 & 13/16"	8-02090-68500-2	24	6
68800 MM	10, 11, 12, 13, 14, 15, 16, 17, 18 & 19mm	8-02090-68800-3	24	6

10 pc. 3/8 in. Drive 12 pt. Deep Socket Sets

- Durable, precise fitting sockets
- Sizes stamped for easy identification
- Knurled ring around socket base allowing for a secure grip in greasy or oily conditions
- Chrome vanadium steel construction
- Mirror polish finish



Part #	Socket Sizes	UPC	Master	Inner
68600 SAE	1/4, 5/16, 3/8, 7/16, 1/2, 9/16, 5/8, 11/16, 3/4 & 13/16"	8-02090-68600-9	12	6
68700 MM	10, 11, 12, 13, 14, 15, 16, 17, 18 & 19mm	8-02090-68700-6	12	6

3/8 in. Drive Spline Sets

- Includes socket holder
- Fits a variety of fasteners: 12pt, Torx, 6pt, Sq & damaged
- Precise, radial spline teeth engage over a wider area minimizing stress & allow application of high torque without damage to fastener or tool



Part #	Socket Sizes	UPC	Master	Inner
15203 SAE	5/16, 3/8, 7/16, 1/2, 9/16, 5/8, 11/16, & 3/4"	8-02090-15203-0	24	6
15202 MM	8, 10, 12, 13, 14, 17, 18, 19mm	8-02090-15202-3	24	6

1/2 in. F Drive Adapters

- Knurled ring around socket adapter base allowing for a secure grip in greasy or oily conditions
- Chrome vanadium construction
- Mirror polish finish



Part #	Size (in.)	UPC	Master	Inner
62157	1/2 F x 3/8 M	8-02090-62157-4	48	6
62158	1/2 F x 3/4 M	8-02090-62158-1	48	6

1/2 in. Drive Universal Joint **62130**

- Chrome vanadium construction
- Mirror polish finish
- Knurled ring around u-joint base allowing for a secure grip in greasy or oily conditions



UPC	Master	Inner
8-02090-62130-7	48	6

1/2 in. Drive Extensions

- Chrome vanadium construction
- Mirror polish finish

Part #	Size (in.)	UPC	Master	Inner
62143	3	8-02090-62143-7	48	6
62145	5	8-02090-62145-1	48	6
62150	10	8-02090-62150-5	48	6
62153	20	8-02090-62153-6	24	6



3 pc. 1/2 in. Drive Extension Set 62140

- Lengths included: 3, 5 & 10"
- Knurled ring around extension base allowing for a secure grip in greasy or oily conditions
- Chrome vanadium construction
- Mirror polish finish

UPC	Master	Inner
8-02090-62140-6	24	6



3 pc. 1/2 in. Drive Wobble Extension Set 62141

- Lengths included: 3, 5, & 10"
- Knurled ring around extension base allowing for a secure grip in greasy or oily conditions
- Chrome vanadium construction
- Mirror polish finish

UPC	Master	Inner
8-02090-62141-3	24	6

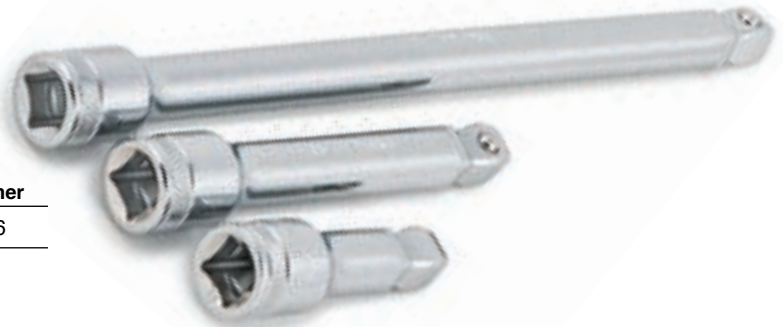

3 pc. 1/2 in. Drive Extra-Long Extension Set 12081

- Lengths included: 18", 24" & 30"
- Chrome plated to resist corrosion
- Extra long for increased accessibility

UPC	Master	Inner
8-02090-12081-7	6	1



1/2 in. Drive Ratcheting Breaker Bar



- 1/2" drive ratchet head swivels 180°
- Heavy duty chrome vanadium steel construction
- Maximum torque: 376 ft/lbs (52 kg/m)
- 3-way ratcheting action: right-hand thread, left-hand thread or lock
- Chrome plated bar and black oxide finish head to resist corrosion
- Packaged on an injection hanger

Part #	Size (in.)	UPC	Master	Inner
12018	18	8-02090-12018-3	12	3
12024	24	8-02090-12024-4	12	3



1/2 in. Drive 30 in. Breaker Bar 12047

- Heavy duty chrome vanadium steel construction
- Maximum torque: 335 ft-lbs (46 kg/m)
- Chrome plated bar and black oxide finish head to resist corrosion
- Replacement head available: # 12021

UPC	Master	Inner
8-02090-12047-3	12	6

1/2 in. Drive Breaker Bars

- Flex head style with flex handle
- Rugged and durable construction helps make tough jobs easier
- Mirror polish finish

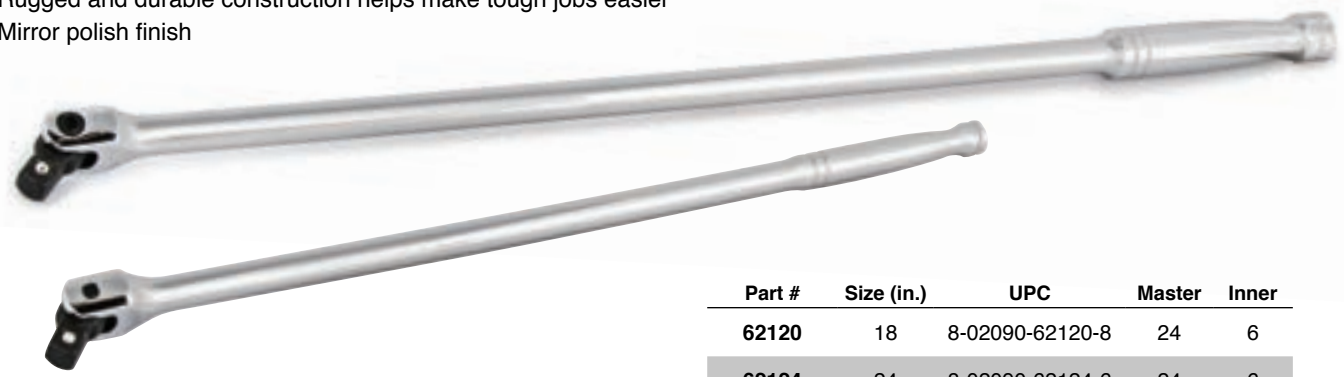

Part #	Size (in.)	UPC	Master	Inner
62120	18	8-02090-62120-8	24	6
62124	24	8-02090-62124-6	24	6

1/2 in. Drive 24 in. Extra-Long Flex-Head Ratchet 11302

- Overall Length: 24"
- 72 tooth ratchet design
- Extra long flex head design for hard to reach fasteners
- TPR comfort grip handle
- Rebuild kit part # 11310



UPC	Master	Inner
8-02090-11302-4	12	6

1/2 in. Drive 24 in. Extra-Long Ratchet 11306

- Overall Length: 24"
- 73 tooth ratchet design
- Extra long flex head design for hard to reach fasteners
- TPR comfort grip handle
- Rebuild kit part # 11310



UPC	Master	Inner
8-02090-11306-2	12	6

1/2 in. Drive Offset Extra-Long Ratchet 12046

- 36-tooth gear-drive ratchet mechanism for high torque applications
- Quick-release feature holds sockets when you want them, lets go when you don't
- Contoured cushion grip handle
- Overall length: 15"



UPC	Master	Inner
8-02090-12046-6	24	6

1/2 in. Drive 16 in. Sealed Head Ratchet 12162

- 90 Tooth mechanism
- 4-Degree Sweep
- Anodized Aluminum Handle
- Overall length: 16"
- Rebuild kit part # 12171



UPC	Master	Inner
8-02090-12162-3	24	6

1/2 in. Drive Offset Ratchet 12044

- Contoured cushion grip handle
- Offset design for hard-to-reach fasteners
- 72 tooth gear drive ratchet mechanism
- Overall length: 9-3/4"

UPC	Master	Inner
8-02090-12044-2	24	6



3/8 in. and 1/2 in. Drive Offset Ratchet 12053

- 72 tooth ratchet mechanism engages with just 5 degrees of sweep for work in the tightest spaces
- Contoured cushion grip handle

UPC	Master	Inner
8-02090-12053-4	24	6



3/8 in. and 1/2 in. Drive Stubby Ratchet 12051

- 72 tooth ratchet mechanism engages with just 5 degrees of sweep for work in the tightest spaces
- Contoured cushion grip handle

UPC	Master	Inner
8-02090-12051-0	48	6



3/8 in. and 1/2 in. Drive Flex-Head Ratchet 12351

- 72 tooth ratchet mechanism engages with just 5 degrees of sweep for work in the tightest spaces
- Contoured cushion grip handle

UPC	Master	Inner
8-02090-12351-1	48	6



1/2 in. Drive Finger Ratchet 12092

- Reversible ratchet
- For use in confined spaces

UPC	Master	Inner
8-02090-12092-3	96	12



1/2 in. Drive Teardrop Ratchet 62101

- Quick release teardrop ratchet
- Smooth ratcheting action
- Rugged and durable construction help make tough jobs easier
- Mirror polish finish
- Overall length: 9-3/4"

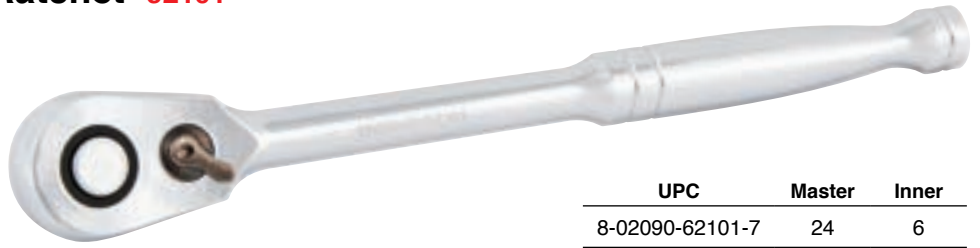

UPC	Master	Inner
8-02090-62101-7	24	6

1/2 in. Drive Flex Head Teardrop Ratchet 62102

- Quick release flex head teardrop ratchet
- Smooth ratcheting action
- Rugged and durable construction help make tough jobs easier
- Mirror polish finish
- Overall length: 17-1/2"



UPC	Master	Inner
8-02090-62102-4	24	6

1/2 in. Drive Round Head Ratchet 62106

- Quick release round head ratchet
- Smooth ratcheting action
- Rugged and durable construction help make tough jobs easier
- Mirror polish finish
- Overall length: 9-3/4"



UPC	Master	Inner
8-02090-62106-2	24	6

1/2 in. Drive Extendable Ratchet 12074

- Telescopes from 12-17" (305-445mm) in 6 increments
- Quick release feature
- Contoured cushion grip handle
- 72 Tooth Ratchet Mechanism

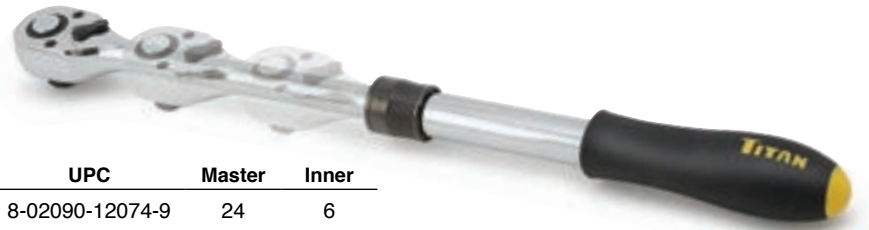

UPC	Master	Inner
8-02090-12074-9	24	6

1/2 in. Drive Extendable Ratchet 12073

- Telescopes from 18 - 23-1/2" (457-597mm) in 6 increments
- Quick release feature
- Contoured cushion grip handle
- 72 Tooth Ratchet Mechanism

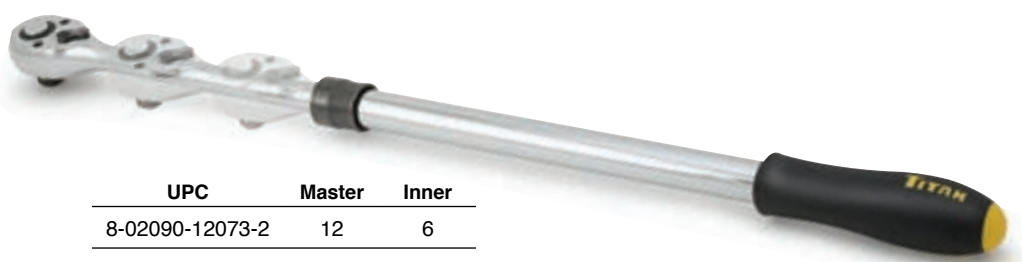

UPC	Master	Inner
8-02090-12073-2	12	6

1/2 in. Drive SAE Standard 6 pt. Sockets

- Sizes stamped for easy identification
- Knurled ring around socket base allowing for a secure grip in greasy or oily conditions



Part #	Size (in.)	UPC	Master	Inner
62012	3/8	8-02090-62012-6	48	6
62014	7/16	8-02090-62014-0	48	6
62016	1/2	8-02090-62016-4	48	6
62018	9/16	8-02090-62018-8	48	6
62020	5/8	8-02090-62020-1	48	6
62022	11/16	8-02090-62022-5	48	6
62024	3/4	8-02090-62024-9	48	6
62026	13/16	8-02090-62026-3	48	6
62028	7/8	8-02090-62028-7	48	6
62030	15/16	8-02090-62030-0	48	6
62032	1	8-02090-62032-4	48	6
62034	1-1/16	8-02090-62034-8	48	6
62036	1-1/8	8-02090-62036-2	48	6
62038	1-3/16	8-02090-62038-6	48	6
62040	1-1/4	8-02090-62040-9	48	6

1/2 in. Drive Metric Standard 6 pt. Sockets

- Sizes stamped for easy identification
- Knurled ring around socket base allowing for a secure grip in greasy or oily conditions



Part #	Size (mm)	UPC	Master	Inner
62210	10	8-02090-62210-6	48	6
62211	11	8-02090-62211-3	48	6
62212	12	8-02090-62212-0	48	6
62213	13	8-02090-62213-7	48	6
62214	14	8-02090-62214-4	48	6
62215	15	8-02090-62215-1	48	6
62216	16	8-02090-62216-8	48	6
62217	17	8-02090-62217-5	48	6
62218	18	8-02090-62218-2	48	6
62219	19	8-02090-62219-9	48	6
62220	20	8-02090-62220-5	48	6
62221	21	8-02090-62221-2	48	6
62222	22	8-02090-62222-9	48	6
62223	23	8-02090-62223-6	48	6
62224	24	8-02090-62224-3	48	6
62225	25	8-02090-62225-0	48	6
62226	26	8-02090-62226-7	48	6
62227	27	8-02090-62227-4	48	6
62228	28	8-02090-62228-1	48	6
62229	29	8-02090-62229-8	48	6
62230	30	8-02090-62230-4	48	6
62232	32	8-02090-62232-8	48	6

1/2 in. Drive Spark Plug Sockets

- Durable, precise fitting socket
- Sizes stamped for easy identification
- Knurled ring around socket base allowing for a secure grip in greasy or oily conditions

Part #	Size (in.)	UPC	Master	Inner
62160	5/8	8-02090-62160-4	48	6
62163	13/16	8-02090-62163-5	48	6





1/2 in. Drive SAE Deep 6 pt. Sockets

- Sizes stamped for easy identification
- Knurled ring around socket base allowing for a secure grip in greasy or oily conditions

Part #	Size (in.)	UPC	Master	Inner
62316	1/2	8-02090-62316-5	48	6
62318	9/16	8-02090-62318-9	48	6
62320	5/8	8-02090-62320-2	48	6
62322	11/16	8-02090-62322-6	48	6
62324	3/4	8-02090-62324-0	48	6
62326	13/16	8-02090-62326-4	48	6
62328	7/8	8-02090-62328-8	48	6

Part #	Size (in.)	UPC	Master	Inner
62330	15/16	8-02090-62330-1	48	6
62332	1	8-02090-62332-5	48	6
62334	1-1/16	8-02090-62334-9	48	6
62336	1-1/8	8-02090-62336-3	48	6
62338	1-3/16	8-02090-62338-7	48	6
62340	1-1/4	8-02090-62340-0	48	6



1/2 in. Drive Metric Deep 6 pt. Sockets

- Sizes stamped for easy identification
- Knurled ring around socket base allowing for a secure grip in greasy or oily conditions

Part #	Size (mm)	UPC	Master	Inner
62410	10	8-02090-62410-0	48	6
62411	11	8-02090-62411-7	48	6
62412	12	8-02090-62412-4	48	6
62413	13	8-02090-62413-1	48	6
62414	14	8-02090-62414-8	48	6
62415	15	8-02090-62415-5	48	6
62416	16	8-02090-62416-2	48	6
62417	17	8-02090-62417-9	48	6
62418	18	8-02090-62418-6	48	6
62419	19	8-02090-62419-3	48	6
62420	20	8-02090-62420-9	48	6

Part #	Size (mm)	UPC	Master	Inner
62421	21	8-02090-62421-6	48	6
62422	22	8-02090-62422-3	48	6
62423	23	8-02090-62423-0	48	6
62424	24	8-02090-62424-7	48	6
62425	25	8-02090-62425-4	48	6
62426	26	8-02090-62426-1	48	6
62427	27	8-02090-62427-8	48	6
62428	28	8-02090-62428-5	48	6
62429	29	8-02090-62429-2	48	6
62430	30	8-02090-62430-8	48	6
62432	32	8-02090-62432-2	48	6



1/2 in. Drive SAE Deep 12 pt. Sockets

- Sizes stamped for easy identification
- Knurled ring around socket base allowing for a secure grip in greasy or oily conditions

Part #	Size (in.)	UPC	Master	Inner
62616	1/2	8-02090-62616-6	48	6
62618	9/16	8-02090-62618-0	48	6
62620	5/8	8-02090-62620-3	48	6
62622	11/16	8-02090-62622-7	48	6
62624	3/4	8-02090-62624-1	48	6
62626	13/16	8-02090-62626-5	48	6
62628	7/8	8-02090-62628-9	48	6

Part #	Size (in.)	UPC	Master	Inner
62630	15/16	8-02090-62630-2	48	6
62632	1	8-02090-62632-6	48	6
62634	1-1/16	8-02090-62634-0	48	6
62636	1-1/8	8-02090-62636-4	48	6
62638	1-3/16	8-02090-62638-8	48	6
62640	1-1/4	8-02090-62640-1	48	6



1/2 in. Drive Metric Deep 12 pt. Sockets

- Sizes stamped for easy identification
- Knurled ring around socket base allowing for a secure grip in greasy or oily conditions

Part #	Size (in.)	UPC	Master	Inner
62710	10	8-02090-62710-1	48	6
62711	11	8-02090-62711-8	48	6
62712	12	8-02090-62712-5	48	6
62713	13	8-02090-62713-2	48	6
62714	14	8-02090-62714-9	48	6
62715	15	8-02090-62715-6	48	6
62716	16	8-02090-62716-3	48	6
62717	17	8-02090-62717-0	48	6
62718	18	8-02090-62718-7	48	6
62719	19	8-02090-62719-4	48	6
62720	20	8-02090-62720-0	48	6

Part #	Size (mm)	UPC	Master	Inner
62721	21	8-02090-62721-7	48	6
62722	22	8-02090-62722-4	48	6
62723	23	8-02090-62723-1	48	6
62724	24	8-02090-62724-8	48	6
62725	25	8-02090-62725-5	48	6
62726	26	8-02090-62726-2	48	6
62727	27	8-02090-62727-9	48	6
62728	28	8-02090-62728-6	48	6
62729	29	8-02090-62729-3	48	6
62730	30	8-02090-62730-9	48	6
62732	32	8-02090-62732-3	48	6

9 pc. 1/2 in. Drive 6 pt. Standard Socket Sets

- Durable, precise fitting socket
- Sizes stamped for easy identification
- Knurled ring around socket base allowing for a secure grip in greasy or oily conditions
- Chrome vanadium steel construction
- Mirror polish finish



Part #	Socket Sizes	UPC	Master	Inner
62002 SAE	1/2, 9/16, 5/8, 11/16, 3/4, 13/16, 7/8, 15/16, and 1 in.	8-02090-62002-7	24	6
62202 MM	10, 11, 12, 13, 14, 15, 16, 17, 18 & 19mm	8-02090-62202-1	24	6

9 pc. 1/2 in. Drive 12 pt. Standard Socket Sets

- Durable, precise fitting socket
- Sizes stamped for easy identification
- Knurled ring around socket base allowing for a secure grip in greasy or oily conditions
- Chrome vanadium steel construction
- Mirror polish finish



Part #	Socket Sizes	UPC	Master	Inner
62500 SAE	1/2, 9/16, 5/8, 11/16, 3/4, 13/16, 7/8, 15/16, and 1 in.	8-02090-62500-8	24	6
62800 MM	12, 13, 14, 15, 16, 17, 18, 19, and 22mm	8-02090-62800-9	48	6

8 pc. 1/2 in. Drive 6 pt. Deep Socket Sets

- Durable, precise fitting socket
- Sizes stamped for easy identification
- Knurled ring around socket base allowing for a secure grip in greasy or oily conditions
- Chrome vanadium steel construction
- Mirror polish finish



Part #	Socket Sizes	UPC	Master	Inner
62300 SAE	1/2, 9/16, 5/8, 11/16, 3/4, 13/16, 7/8 & 15/16 in.	8-02090-62300-4	12	6
62400 MM	12, 13, 14, 15, 16, 17, 18 & 19mm	8-02090-62400-1	48	12

8 pc. 1/2 in. Drive 12 pt. Deep Socket Sets

- Durable, precise fitting socket
- Sizes stamped for easy identification
- Knurled ring around socket base allowing for a secure grip in greasy or oily conditions
- Chrome vanadium steel construction
- Mirror polish finish



Part #	Socket Sizes	UPC	Master	Inner
62600 SAE	1/2, 9/16, 5/8, 11/16, 3/4, 13/16, 7/8 & 15/16 in.	8-02090-62600-5	12	6
62700 MM	12, 13, 14, 15, 16, 17, 18 & 19mm	8-02090-62700-2	12	6

3/4 in. F Drive Increasing/Reducing Adapters



Part #	Size (in.)	UPC	Master	Inner
64158	3/4 F x 1 M	8-02090-64158-9	48	6
64157	3/4 F x 1/2 M	8-02090-64157-2	48	6
64159	1 F x 3/4 M	8-02090-6415-96	36	6

3/4 in. Drive Extensions

- Chrome vanadium steel construction
- Mirror polish finish
- Shaft knurled for a secure grip in greasy or oily conditions



Part #	Size (in.)	UPC	Master	Inner
64144	4	8-02090-64144-2	24	6
64148	8	8-02090-64148-0	24	6

3/4 in. Drive Universal Joint 64130

UPC	Master	Inner
8-02090-64130-5	24	6



3/4 in. Drive x 40 in. Breaker Bar 12048

- Heavy duty chrome vanadium steel construction
- Maximum torque: 1000 ft-lbs (138 kg/m)
- Chrome plated bar and black oxide finish head to resist corrosion
- REPLACEMENT HEAD available: # 12022



UPC	Master	Inner
8-02090-12048-0	6	1

1 in. Drive x 40 in. Breaker Bar 12049

- Heavy duty chrome vanadium steel construction
- Maximum torque: 1855 ft-lbs (256 kg/m)
- Chrome plated bar and black oxide finish head to resist corrosion
- REPLACEMENT HEAD available: # 12023



UPC	Master	Inner
8-02090-12049-7	4	2

3/4 in. Drive Extendable Ratchet 12072

- Telescopes from 19.5 - 30.5" (495.3 - 774.7 mm) in 4 increments
- Quick release feature
- Knurled handle for better grip
- 24 Tooth Ratchet Mechanism



UPC	Master	Inner
8-02090-12072-5	4	1

Ratchet Rebuild Kits

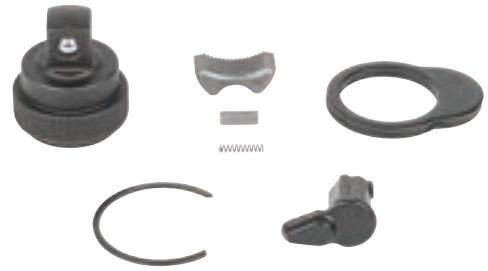

Part #	Ratchet Part #	Drive Size (in.)	UPC	Master	Inner
11308	11300, 11074*, 11085*	1/4	8-02090-11308-6	120	1
11309	11301, 11086,* 12045*	3/8	8-02090-11309-3	120	1
11310	11302, 12046*	1/2	8-02090-11310-9	120	1
12169	12160	1/4	8-02090-12169-2	50	1
12170	12161	3/8	8-02090-12170-8	50	1
12171	12162	1/2	8-02090-12171-5	50	1
12172	12167	1/4	8-02090-12172-2	1	1
12173	12168	3/8	8-02090-12173-9	1	1
12174	12073, 12074	1/2	8-02090-12174-6	1	1
11083	12045	3/8	8-02090-11083-2	120	20
11082	12046	1/2	8-02090-11082-5	120	20

*Not exact replacement

Breaker Bar Replacement Heads

- Heavy duty chrome vanadium steel construction
- 3-way ratcheting action: right-hand thread, left-hand thread or lock (12027 & 12028 only)
- Chrome plated bar and black oxide finish head to resist corrosion



Part #	Breaker Bar Part #	Drive Size (in.)	UPC	Master	Inner
12021	12047	1/2	8-02090-12021-3	60	1
12022	12048	3/4	8-02090-12022-0	50	1
12023	12049	1	8-02090-12023-7	20	1
12027	12015	3/8	8-02090-12027-5	60	1
12028	12018, 12024	1/2	8-02090-12028-2	60	1

SAE Hex Bit Sockets



Part #	Size (in.)	Drive Size (in.)	UPC	Master	Inner
15650	5/64	1/4	8-02090-15650-2	96	12
15651	3/32	1/4	8-02090-15651-9	96	12
15652	7/64	1/4	8-02090-15652-6	96	12
15653	1/8	1/4	8-02090-15653-3	96	12
15654	9/64	1/4	8-02090-15654-0	96	12
15655	5/32	1/4	8-02090-15655-7	96	12
15656	3/16	3/8	8-02090-15656-4	96	12
15657	7/32	3/8	8-02090-15657-1	96	12
15658	1/4	3/8	8-02090-15658-8	96	12
15659	5/16	3/8	8-02090-15659-5	96	6
15660	3/8	3/8	8-02090-15660-1	96	6
15661	7/16	1/2	8-02090-15661-8	48	6
15662	1/2	1/2	8-02090-15662-5	48	6
15663	9/16	1/2	8-02090-15663-2	48	6
15664	5/8	1/2	8-02090-15664-9	48	6
15665	11/16	1/2	8-02090-15665-6	48	6
15666	3/4	1/2	8-02090-15666-3	48	6
15667	13/16	1/2	8-02090-15667-0	48	6
15668	7/8	1/2	8-02090-15668-7	48	6
15669	15/16	1/2	8-02090-15669-4	48	6
15670	1	1/2	8-02090-15670-0	48	6

Metric Hex Bit Sockets



Part #	Size (mm)	Drive Size (in.)	UPC	Master	Inner
15602	2	1/4	8-02090-15602-1	96	6
15600	2.5	1/4	8-02090-15600-7	96	6
15603	3	1/4	8-02090-15603-8	96	6
15604	4	1/4	8-02090-15604-5	96	6
15605	5	1/4	8-02090-15605-2	96	6
15601	5.5	1/4	8-02090-15601-4	96	6
15606	6	3/8	8-02090-15606-9	96	6
15607	7	3/8	8-02090-15607-6	96	6
15608	8	3/8	8-02090-15608-3	96	6
15609	9	3/8	8-02090-15609-0	96	6
15610	10	3/8	8-02090-15610-6	96	6
15611	11	1/2	8-02090-15611-3	48	6
15612	12	1/2	8-02090-15612-0	48	6
15613	13	1/2	8-02090-15613-7	48	6
15614	14	1/2	8-02090-15614-4	48	6
15615	15	1/2	8-02090-15615-1	48	6
15616	16	1/2	8-02090-15616-8	48	6
15617	17	1/2	8-02090-15617-5	48	6
15618	18	1/2	8-02090-15618-2	48	6
15619	19	1/2	8-02090-15619-9	48	6
15620	20	1/2	8-02090-15620-5	48	6
15621	21	1/2	8-02090-15621-2	48	6
15622	22	1/2	8-02090-15622-9	48	6

Star Bit Sockets

- Knurled ring around socket base allowing for a secure grip in greasy or oily conditions
- Mirror polish finish



Part #	Size	Drive Size (in.)	UPC	Master	Inner
66910	T10	1/4	8-02090-66910-1	96	12
66915	T15	1/4	8-02090-66915-6	96	12
66920	T20	1/4	8-02090-66920-0	96	12
66925	T25	1/4	8-02090-66925-5	96	12
66927	T27	1/4	8-02090-66927-9	96	12
66930	T30	1/4	8-02090-66930-9	96	12
68940	T40	3/8	8-02090-68940-6	96	12
68945	T45	3/8	8-02090-68945-1	96	12
68947	T47	3/8	8-02090-68947-5	96	12
68950	T50	3/8	8-02090-68950-5	96	12
68955	T55	3/8	8-02090-68955-0	96	12
62960	T60	1/2	8-02090-62960-0	96	12
62970	T70	1/2	8-02090-62970-9	48	6

Tamper Resistant Star Bit Sockets

- Knurled ring around socket base allowing for a secure grip in greasy or oily conditions
- Mirror polish finish



Part #	Size	Drive Size (in.)	UPC	Master	Inner
66810	TR10	1/4	8-02090-66810-4	48	6
66815	TR15	1/4	8-02090-66815-9	48	6
66820	TR20	1/4	8-02090-66820-3	48	6
66825	TR25	1/4	8-02090-66825-8	96	12
66827	TR27	1/4	8-02090-66827-2	48	6
66830	TR30	1/4	8-02090-66830-2	48	6
68840	TR40	3/8	8-02090-68840-9	48	6
68845	TR45	3/8	8-02090-68845-4	48	6
68847	TR47	3/8	8-02090-68847-8	48	6
68850	TR50	3/8	8-02090-68850-8	48	6
68855	TR55	3/8	8-02090-68855-3	48	6
62860	TR60	1/2	8-02090-62860-3	48	6

13 pc. Hex Bit Sets

- 1/4" and 3/8" drive bit holders
- Handy magnetic rack sticks to ferrous metal surfaces

Part #	Socket Sizes	UPC	Master	Inner
16111 SAE	1/16, 3/32, 1/8, 9/64, 5/32, 3/16, 7/32, 1/4, 5/16, 3/8, 7/16	8-02090-16111-7	48	6
16112 MM	1.5, 2, 2.5, 3, 4, 5, 5.5, 6, 7, 8, 10	8-02090-16112-4	48	6

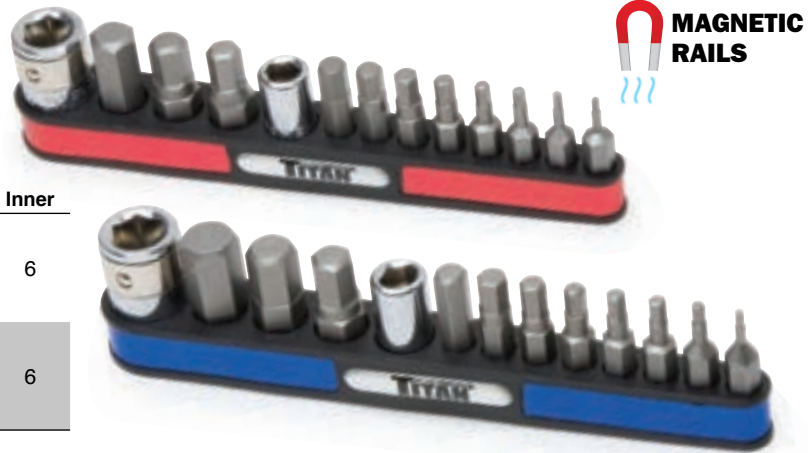

1/2 in. Drive Large Hex Bit Sets

- Handy magnetic rack sticks to ferrous metal surfaces
- Anodized rails (16130 Red, 16131 Blue)

Part #	Socket Sizes	UPC	Master	Inner
16130 SAE	9/16, 5/8, 11/16, 3/4, 13/16, & 7/8"	8-02090-16130-8	12	4
16131 MM	13, 14, 15, 17, 19, 21 & 22mm	8-02090-16131-5	12	4



3 pc. Metric Jumbo Bit Socket Set **16163**

- Set includes: 12mm, 14mm & 17mm
- Full polish
- Chrome vanadium construction



UPC	Master	Inner
8-02090-16163-6	48	12

10 pc. 3/8 in. Drive Metric Hex Bit Socket Set **16170**

- 3/8" Drive: 2mm, 3mm, 4mm, 5mm, 5.5mm, 6mm, 7mm, 8mm, 9mm & 10mm
- Bonus storage rail included
- Chrome vanadium steel construction

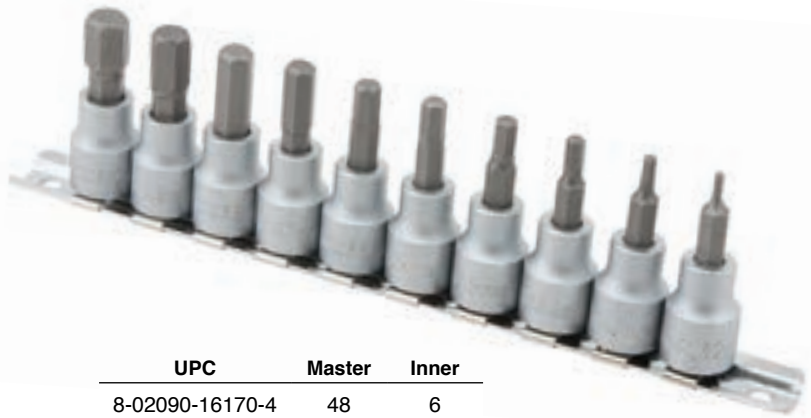

UPC	Master	Inner
8-02090-16170-4	48	6

9 pc. Stubby Hex Bit Socket Sets

- Includes rail storage rack



Part #	Socket Sizes	UPC	Master	Inner
16140 SAE	1/4" Dr: 1/4, 5/16, & 3/8"	8-02090-16140-7	24	6
	3/8" Dr: 7/16, 1/2, 9/16, 5/8, 11/16, & 3/4"			
16141 MM	1/4" Dr: 6, 7, 8, & 10mm	8-02090-16141-4	24	6
	3/8" Dr: 12, 14, 17, 18, & 19mm			

8 pc. 3/8 in. Drive Metric Hex Bit Socket Set 68890

- Sizes include: 3, 4, 5, 6, 7, 8, 9 & 10mm
- Chrome vanadium sockets with S-2 Alloy bits
- Mirror polish finish
- Knurled ring around socket base allowing for a secure grip in greasy or oily conditions



UPC	Master	Inner
8-02090-68890-4	48	6

13 pc. SAE Hex Bit Socket Set 16123

- Handy magnetic rack sticks to ferrous metal surfaces
- Anodized red rail
- Sizes include:
 - 1/4" Dr: 5/64, 3/32, 7/64, 1/8, 9/64, & 5/32"
 - 3/8" Dr: 3/16, 7/32, 1/4, 5/16, & 3/8"
 - 1/2" Dr: 7/16 & 1/2"

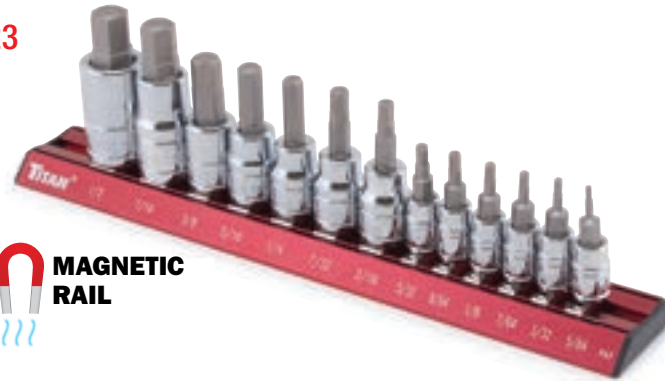

UPC	Master	Inner
8-02090-16123-0	24	6

7 pc. Metric Large Hex Bit Socket Set 16157

- Reusable rail for added convenience
- Sizes include:
 - 1/2" Dr: 13, 14, 15, 17, 19, 21 & 22mm



UPC	Master	Inner
8-02090-16157-5	12	6

6 pc. SAE Large Hex Bit Socket Set 16156

- Reusable rail for added convenience
- Sizes include:
 - 1/2" Dr: 9/16, 5/8, 11/16, 3/4, 13/16, & 7/8"

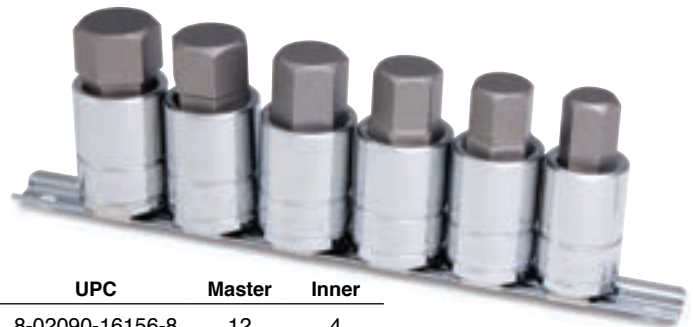

UPC	Master	Inner
8-02090-16156-8	12	4

8 pc. 3/8 in. Drive Hex Bit Socket Sets



Part #	Socket Sizes	UPC	Master	Inner
68871 SAE	1/8, 9/64, 5/32, 3/16, 7/32, 1/4, 5/16 & 3/8 in.	8-02090-68871-3	48	6
68891 MM	3, 4, 5, 6, 7, 8, 9 & 10mm	8-02090-68891-1	48	6

3 pc. SAE Hex Bit Socket Set

16162

- Set includes:
1/2", 9/16" &
5/8"
- Full polish
- Chrome vanadium construction



UPC	Master	Inner
8-02090-16162-9	48	12

10 pc. 3/8 in. Drive SAE Hex Bit Set 16169

- 3/8" Drive: 3/32, 7/64, 1/8, 9/64, 5/32, 3/16, 7/32, 1/4, 5/16, & 3/8"
- Bonus storage rail included
- Chrome vanadium steel construction

UPC	Master	Inner
8-02090-16169-8	48	6



8 pc. 3/8 in. Drive SAE Hex Bit Socket Set 68870

- Sizes include: 1/8, 9/64, 5/32, 3/16, 7/32, 1/4, 5/16 & 3/8"
- Chrome vanadium sockets with S-2 Alloy bits
- Knurled ring around socket base allowing for a secure grip in greasy or oily conditions
- Mirror polish finish

UPC	Master	Inner
8-02090-68870-6	24	6



8 pc. SAE/Metric Large Hex Bit Socket Set 16132

- Handy magnetic rack sticks to ferrous metal surfaces
- Anodized gold rail
- Sizes include:
- 1/2" Dr: SAE: 9/16, 5/8, 11/16, & 3/4"
- 1/2" Dr: MM: 14, 15, 17, & 19mm

UPC	Master	Inner
8-02090-16132-2	12	4

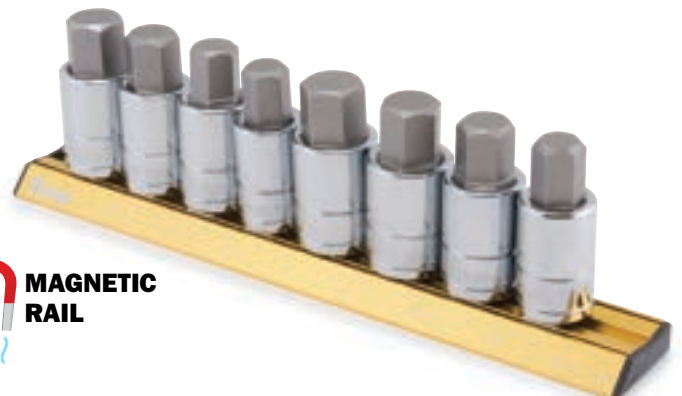



43 pc. Master Star Bit Socket Set 54137

- (12) External Star Sockets: 1/4" Dr.: E4, E5, E6, E7, E8; 3/8" Dr.: E10, E12, E14; 1/2" Dr.: E18, E20, E22, E24
- (13) Star Bit Sockets: 1/4" Dr.: T10, T15, T20, T25, T27, T30; 3/8" Dr.: T40, T45, T47, T50, T55
- 1/2" Dr.: T60, T70
- (12) Tamper Resistant Star Bit Sockets:
 - 1/4" Dr.: TR10, TR15, TR20, TR25, TR27, TR30; 3/8" Dr.: TR40, TR45, TR47, TR50, TR55; 1/2" Dr.: TR60
- (6) 1/4" Star Bits: T4, T5, T6, T7, T8, T9

UPC	Master	Inner
8-02090-54137-7	5	1

6 pc. Star Bit Socket Set 16116

- Include socket holder
- Sizes includes:
 - 3/8" Dr: T40, T45, T47, & T50
 - 1/2" Dr: T55 & T60



UPC	Master	Inner
8-02090-16116-2	24	6

13 pc. Star Bit Socket Set 16122

- For use with Star fastener
- S2 alloy steel bits for strength and durability
- Anodized aluminum green rail
- Handy magnetic rack sticks to ferrous metal surfaces
- Rust Resistant Finish



UPC	Master	Inner
8-02090-16122-3	24	6

10 pc. Stubby Star Bit Socket Set 16142

- Sizes include:
 - 1/4" Dr: T10, T15, T20, T25, T27, & T30
 - 3/8" Dr: T40, T45, T47, & T50
- Includes rail storage rack



UPC	Master	Inner
8-02090-16142-1	24	6

9 pc. 3/8 in. Drive Star Bit Socket Set 16171

- 3/8" Drive: T10, T15, T20, T25, T27, T30, T40, T45 & T50
- Bonus storage rail included
- Chrome vanadium steel construction

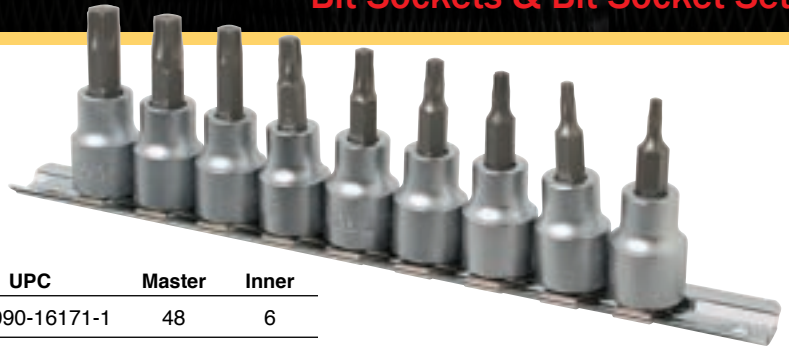

UPC	Master	Inner
8-02090-16171-1	48	6

12 pc. Star Bit Socket Set 68802

- 1/4" Dr. T10, T15, T20, T25, T27 & T30
- 3/8" Dr. T40, T45, T47, T50 & T55
- 1/2" Dr. T60
- Chrome vanadium sockets with S-2 Alloy bits
- Knurled ring around socket base allowing for a secure grip in greasy or oily conditions
- Mirror polish finish



UPC	Master	Inner
8-02090-68802-7	24	6



4 pc. Star Bit Socket Set 68804

- Sizes include: T45, T47, T50 & T55
- Chrome vanadium sockets with S-2 Alloy bits
- Knurled ring around socket base allowing for a secure grip in greasy or oily conditions
- Mirror polish finish

UPC	Master	Inner
8-02090-68804-1	48	6

17 pc. External Torx® Socket & Bit Set 16160

- Contains a combination of 17 external star sockets and star bit sockets
- Set includes: (3) 1/4 in. Drive E-Sockets: E6, E7 and E8; (4) 3/8 in. Drive E-Sockets: E10, E12, E14 and E16; (1) 3/8 in. Drive Bit Adapter; (9) Star Bits, sizes: T10, T15, T20, T25, T30, T40, T45, T50 and T55
- Constructed from chrome vanadium steel



UPC	Master	Inner
8-02090-16160-5	36	6



9 pc. External Star Socket Set 16139

- - 1/4" Dr.: E5, E6, E7, E8
- - 3/8" Dr.: E10, E12, E14, E16
- - 1/4" (M) x 3/8" (F) Socket Adapter

UPC	Master	Inner
8-02090-16139-1	36	6



13 pc. E-Star Socket Set 17403

- Includes the following sockets:
- 1/4" Dr - E4, E5, E6, E7, E8
- 3/8" Dr - E10, E12, E14, E16
- 1/2" Dr - E18, E20, E22, E24

UPC	Master	Inner
8-02090-17403-2	24	6

13 pc. Tamper Resistant 5-Lobe Star Bit Socket Set 16137

- 1/4" and 3/8" drive bit holders
- 11 bits TP8, TP10, TP15, TP20, TP25, TP27, TP30, TP40, TP45, TP50, TP55
- Handy magnetic rack sticks to ferrous metal surfaces



UPC	Master	Inner
8-02090-16137-7	48	6

13 pc. Tamper Resistant Star Bit Set 16113

- For use with pin type tamper resistant star fasteners
- 1/4" and 3/8" drive bit holders
- 11 bits, TR8, TR10, TR15, TR20, TR25, TR27, TR30, TR40, TR45, TR50 and TR55
- Handy magnetic rack sticks to ferrous metal surfaces



UPC	Master	Inner
8-02090-16113-1	48	6

12 pc. Tamper Resistant Star Bit Socket Set 16121

- Includes 1/4" dr. TR10, TR15, TR20, TR25, TR27, and TR30 bits; 3/8" dr. TR40, TR45, TR47, and TR50 bits; and 1/2" dr. TR60 bit
- For use with pin type tamper resistant Star fastener
- S2 alloy steel bits for strength and durability
- Rust Resistant finish
- Anodized aluminum green rail
- Handy magnetic rack sticks to ferrous metal surfaces

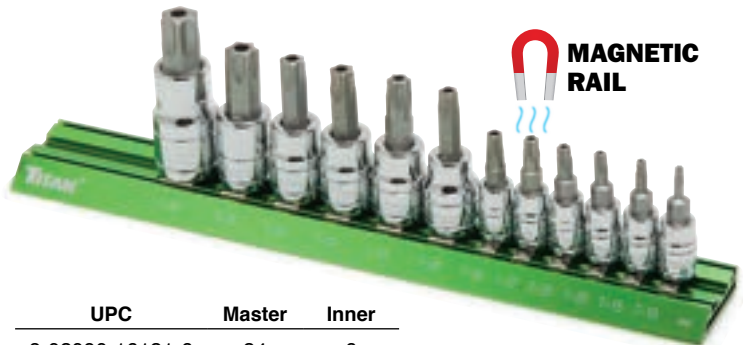

UPC	Master	Inner
8-02090-16121-6	24	6

13 pc. Metric Hex Bit Socket Set 16124

- Handy magnetic rack sticks to ferrous metal surfaces
- Anodized blue rail
- Sizes include:
- 1/4" Dr: 2, 2.5, 3, 4, 5, 5.5mm
- 3/8" Dr: 6-10mm
- 1/2" Dr: 11&12mm

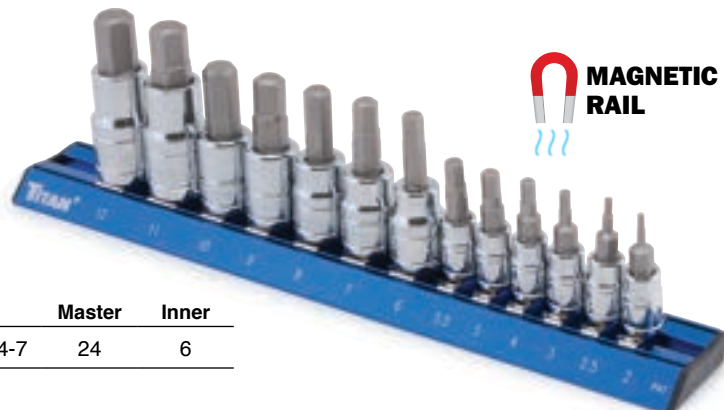

UPC	Master	Inner
8-02090-16124-7	24	6

13 pc. Tamper Resistant Hex Bit Socket Sets

- Tamper Resistant
- 1/4" and 3/8" drive bit holders
- Handy magnetic rack sticks to ferrous metal surfaces

Part #	Socket Sizes	UPC	Master	Inner
16135 SAE	1/16, 3/32, 1/8, 9/64, 5/32, 3/16, 7/32, 1/4, 5/16, 3/8, 7/16"	8-02090-16135-3	48	6
16136 MM	1.5, 2, 2.5, 3, 4, 5, 5.5, 6, 7, 8, 10	8-02090-16136-0	48	6



10 pc. Tamper Resistant Stubby Star Bit Socket Set 16143

- Sizes include:
- 1/4" Dr: TR10, TR15, TR20, TR25, TR27, & TR30
- 3/8" Dr: TR40, TR45, TR47, & TR50
- Includes rail storage rack



UPC	Master	Inner
8-02090-16143-8	24	6



9 pc. Stubby Triple Square Bit Socket 16138

- 1/4" Dr MT4 -6, M8
- 3/8" Dr MT10 & M12
- 1/2" Dr MT14, MT16, MT18 (tamper resistant)
- Includes rail storage rack



UPC	Master	Inner
8-02090-16138-4	24	6



3 pc. Tamper Resistant XZN Triple Square Bit Socket Set 16083

- Set Includes: 1/2 Inch Drive M14, M16 and M18
- Fits many fasteners found on imports including VW, Audi, BMW and Porsche
- Chrome Vanadium Socket, S2 Bit



UPC	Master	Inner
8-02090-16083-7	36	6

9 pc. Triple Square Socket Set 16144

- Reusable rail for added convenience
- Sizes include:
- 1/4" Dr: M4 & M5
- 3/8" Dr: M6, M8, & M10
- 1/2" Dr: M12, M14, M16, & M18

UPC	Master	Inner
8-02090-16144-5	24	6



1/4 in. F to 3/8 in. M Drive Increasing Adapter 46155

- Chrome-moly constructed for durability
- Laser etched size markings for easy identification



UPC	Master	Inner
8-02090-46155-2	120	12

1/4in Drive Pin-Free Locking U-Joint 46158

- Chrome-moly constructed for durability
- Laser etched size markings for easy identification



UPC	Master	Inner
8-02090-46158-3	100	1

1/4 in. M to 3/8 in. F Drive Locking Wobble Increasing Adapter 46157

- Chrome-moly construction for durability
- Laser etched size markings for easy identification



UPC	Master	Inner
8-02090-46157-6	24	6

53 pc. 1/4 in. Drive SAE and Metric Combination Impact Socket Set 46053



- Chrome-moly constructed for durability
- Laser etched size markings for easy identification
- Radius corner design reduces fastener wear
- Heavy duty blow molded storage case

UPC	Master	Inner
8-02090-46053-1	5	1

SET CONTENTS

Part #	Description
46006	3/16" 1/4" Dr. 6pt Std Impact Socket
46007	7/32" 1/4" Dr. 6pt Std Impact Socket
46008	1/4" 1/4" Dr. 6pt Std Impact Socket
46009	9/32" 1/4" Dr. 6pt Std Impact Socket
46010	5/16" 1/4" Dr. 6pt Std Impact Socket
46011	11/32" 1/4" Dr. 6pt Std Impact Socket
46012	3/8" 1/4" Dr. 6pt Std Impact Socket
46014	7/16" 1/4" Dr. 6pt Std Impact Socket
46016	1/2" 1/4" Dr. 6pt Std Impact Socket
46018	9/16" 1/4" Dr. 6pt Std Impact Socket
46306	3/16" 1/4" Dr. 6pt Deep Impact Socket
46307	7/32" 1/4" Dr. 6pt Deep Impact Socket
46308	1/4" 1/4" Dr. 6pt Deep Impact Socket
46309	9/32" 1/4" Dr. 6pt Deep Impact Socket
46310	5/16" 1/4" Dr. 6pt Deep Impact Socket
46311	11/32" 1/4" Dr. 6pt Deep Impact Socket
46312	3/8" 1/4" Dr. 6pt Deep Impact Socket
46314	7/16" 1/4" Dr. 6pt Deep Impact Socket

Part #	Description
46316	1/2" 1/4" Dr. 6pt Deep Impact Socket
46318	9/16" 1/4" Dr. 6pt Deep Impact Socket
46204	4mm 1/4" Dr. 6pt Std Impact Socket
46202	4.5mm 1/4" Dr. 6pt Std Impact Socket
46205	5mm 1/4" Dr. 6pt Std Impact Socket
46203	5.5mm 1/4" Dr. 6pt Std Impact Socket
46206	6mm 1/4" Dr. 6pt Std Impact Socket
46207	7mm 1/4" Dr. 6pt Std Impact Socket
46208	8mm 1/4" Dr. 6pt Std Impact Socket
46209	9mm 1/4" Dr. 6pt Std Impact Socket
46210	10mm 1/4" Dr. 6pt Std Impact Socket
46211	11mm 1/4" Dr. 6pt Std Impact Socket
46212	12mm 1/4" Dr. 6pt Std Impact Socket
46213	13mm 1/4" Dr. 6pt Std Impact Socket
46214	14mm 1/4" Dr. 6pt Std Impact Socket
46215	15mm 1/4" Dr. 6pt Std Impact Socket
46404	4mm 1/4" Dr. 6pt Deep Impact Socket
46402	4.5mm 1/4" Dr. 6pt Deep Impact Socket

Part #	Description
46405	5mm 1/4" Dr. 6pt Deep Impact Socket
46403	5.5mm 1/4" Dr. 6pt Deep Impact Socket
46406	6mm 1/4" Dr. 6pt Deep Impact Socket
46407	7mm 1/4" Dr. 6pt Deep Impact Socket
46408	8mm 1/4" Dr. 6pt Deep Impact Socket
46409	9mm 1/4" Dr. 6pt Deep Impact Socket
46410	10mm 1/4" Dr. 6pt Deep Impact Socket
46411	11mm 1/4" Dr. 6pt Deep Impact Socket
46412	12mm 1/4" Dr. 6pt Deep Impact Socket
46413	13mm 1/4" Dr. 6pt Deep Impact Socket
46414	14mm 1/4" Dr. 6pt Deep Impact Socket
46415	15mm 1/4" Dr. 6pt Deep Impact Socket
46142	1/4" Dr 2" Impact Extension
46144	1/4" Dr 4" Impact Extension
46146	1/4" Dr 6" Impact Extension
46155	1/4" Dr F to 3/8" Dr M Impact Sckt Adpt
46130	1/4" Dr. Impact Universal Joint

6 pc. 3/8 in. Drive Impact Socket Accessory Set **48100**

- Set Includes: (1) Universal Joint (1) 3/8" F x 1/4" M Reducer (1) 3/8" F x 1/4" M Adapter (3) Extensions: 1-3/4", 3, & 6"
- Chrome-moly constructed for durability



	UPC	Master	Inner
	8-02090-48100-0	36	6

3 pc. 3/8 in. Drive Impact Extension Bar Set **48140**

- Set Includes: 1-3/4, 3, & 6"
- Chrome-moly constructed for durability



	UPC	Master	Inner
	8-02090-48140-6	24	6

3/8 in. Drive Impact Adapters

- Chrome-moly constructed for durability
- Laser etched size markings for easy identification



Part #	Size (in.)	UPC	Master	Inner
48354	3/8 F x 1/2 M	8-02090-48354-7	120	12
48355	3/8 F x 1/4 M	8-02090-48355-4	120	12

3/8 in. Drive Pin-Free Locking Universal Joint **48160**

- Chrome-moly constructed for durability
- Laser etched size markings for easy identification



	UPC	Master	Inner
	8-02090-48160-4	100	1

3/8 in. Drive Impact Locking Wobble Adapters

- Chrome-moly constructed for durability
- Laser etched size markings for easy identification



Part #	Size (in.)	UPC	Master	Inner
48158	3/8 F x 1/2 M	8-02090-48158-1	100	1
48159	3/8 F x 1/4 M	8-02090-48159-8	100	1

3/8 in. Drive Impact Universal Joint **48130**

- Chrome-moly constructed for durability
- Laser etched size markings for easy identification



	UPC	Master	Inner
	8-02090-48130-7	96	24

3/8 in. Drive Deep Impact Socket Set

- Chrome-moly constructed for durability
- Laser etched size markings for easy identification
- Heavy duty blow molded storage case
- Radius corner design reduces fastener wear



Part #	UPC	Master	Inner
48300 SAE	8-02090-48300-4	5	1

48300 SET CONTENTS

Part #	Description
48310	5/16" 3/8" Dr. 6pt Deep Impact Socket
48312	3/8" 3/8" Dr. 6pt Deep Impact Socket
48314	7/16" 3/8" Dr. 6pt Deep Impact Socket
48316	1/2" 3/8" Dr. 6pt Deep Impact Socket
48318	9/16" 3/8" Dr. 6pt Deep Impact Socket
48320	5/8" 3/8" Dr. 6pt Deep Impact Socket
48322	11/16" 3/8" Dr. 6pt Deep Impact Socket
48324	5/8" 3/8" Dr 6pt Deep Impact Socket
48326	13/16" 3/8" Dr. 6pt Deep Impact Socket
48328	7/8" 3/8" Dr. 6pt Deep Impact Socket
48330	15/16" 3/8" Dr. 6pt Deep Impact Socket
48332	1" 3/8" Dr. 6pt Deep Impact Socket



Part #	UPC	Master	Inner
48400 SAE	8-02090-48400-1	5	1

48400 SET CONTENTS

Part #	Description
48407	7mm 3/8" Dr. 6pt Deep Impact Socket
48408	8mm 3/8" Dr. 6pt Deep Impact Socket
48409	9mm 3/8" Dr. 6pt Deep Impact Socket
48410	10mm 3/8" Dr. 6pt Deep Impact Socket
48411	11mm 3/8" Dr. 6pt Deep Impact Socket
48412	12mm 3/8" Dr. 6pt Deep Impact Socket
48413	13mm 3/8" Dr. 6pt Deep Impact Socket
48414	14mm 3/8" Dr. 6pt Deep Impact Socket
48415	15mm 3/8" Dr. 6pt Deep Impact Socket
48416	16mm 3/8" Dr. 6pt Deep Impact Socket
48417	17mm 3/8" Dr. 6pt Deep Impact Socket
48418	18mm 3/8" Dr. 6pt Deep Impact Socket
48419	19mm 3/8" Dr. 6pt Deep Impact Socket

6 pc. 1/2 in. Drive Impact Socket Accessory Set **42100**

- Set Includes: (1) Universal Joint (1) 1/2" F x 3/4" M Reducing Adapter (1) 1/2" F x 3/8" M Increasing Adapter (3) Extensions: 3, 5, & 7"
- Chrome-moly constructed for durability

UPC	Master	Inner
8-02090-42100-6	10	5



1/2 in. Drive Impact Extension Bars

- Chrome-moly constructed for durability
- Laser etched size markings for easy identification

Part #	Length (in.)	UPC	Master	Inner
42140 3-pc	3, 5 & 10	8-02090-42140-2	12	6
42143	3	8-02090-42143-3	80	20
42145	5	8-02090-42145-7	80	20
42150	10	8-02090-42150-1	48	24

1/2 in. Drive Extra-Long Impact Extension Bars

- Chrome-moly constructed for durability
- Laser etched size markings for easy identification



Part #	Length (in.)	UPC	Master	Inner
42173 3-pc	18, 24 & 36	8-02090-42173-0	6	1
42175	18	8-02090-42175-4	24	6
42176	24	8-02090-42176-1	12	6
42177	36	8-02090-42177-8	12	6



1/2 in. Drive Pin-Free Locking Universal Joint **42160**

- Chrome-moly constructed for durability
- Laser etched size markings for easy identification

UPC	Master	Inner
8-02090-42160-0	100	1

1/2 in. Drive Locking Wobble Adapters

- Chrome-moly constructed for durability
- Laser etched size markings for easy identification



Part #	Size (in.)	UPC	Master	Inner
42158	1/2 F x 3/4 M	8-02090-42158-7	24	6
42157	1/2 F x 3/8 M	8-02090-42157-0	100	1

1/2 in. F Impact Adapter

- Chrome-moly constructed for durability
- Laser etched size markings for easy identification



Part #	Size (in.)	UPC	Master	Inner
42355	1/2 F x 3/8 M	8-02090-42355-0	120	12
42356	1/2 F x 3/4 M	8-02090-42356-7	48	6

1/2 in. Drive Impact Socket Universal Joint **42130**

- Chrome-moly constructed for durability
- Laser etched size markings for easy identification

UPC	Master	Inner
8-02090-42130-3	96	24



1/2 in. Drive SAE Deep Impact Socket Sets

- Chrome-moly constructed for durability
- Laser etched size markings for easy identification
- Radius corner design reduces fastener wear
- Heavy duty blow molded storage case



Part #		UPC	Master	Inner
42313	13-PC SAE	8-02090-42313-0	4	1

42313 SET CONTENTS

Part #	Description
42314	7/16" 1/2" Dr. 6pt Deep Impact Socket
42316	1/2" 1/2" Dr. 6pt Deep Impact Socket
42318	9/16" 1/2" Dr. 6pt Deep Impact Socket
42320	5/8" 1/2" Dr. 6pt Deep Impact Socket
42322	11/16" 1/2" Dr. 6pt Deep Impact Socket
42324	3/4" 1/2" Dr. 6pt Deep Impact Socket
42326	13/16" 1/2" Dr. 6pt Deep Impact Socket
42328	7/8" 1/2" Dr. 6pt Deep Impact Socket
42330	15/16" 1/2" Dr. 6pt Deep Impact Socket
42332	1" 1/2" Dr. 6pt Deep Impact Socket
42334	1-1/16" 1/2" Dr. 6pt Deep Impact Socket
42336	1-1/8" 1/2" Dr. 6pt Deep Impact Socket
42340	1-1/4" 1/2" Dr. 6pt Deep Impact Socket

Part #		UPC	Master	Inner
42319	19-PC SAE	8-02090-42319-2	2	1

42319 SET CONTENTS

Part #	Description
42312	3/8" 1/2" Dr. 6pt Deep Impact Socket
42314	7/16" 1/2" Dr. 6pt Deep Impact Socket
42316	1/2" 1/2" Dr. 6pt Deep Impact Socket
42318	9/16" 1/2" Dr. 6pt Deep Impact Socket
42320	5/8" 1/2" Dr. 6pt Deep Impact Socket
42322	11/16" 1/2" Dr. 6pt Deep Impact Socket
42324	3/4" 1/2" Dr. 6pt Deep Impact Socket
42326	13/16" 1/2" Dr. 6pt Deep Impact Socket
42328	7/8" 1/2" Dr. 6pt Deep Impact Socket
42330	15/16" 1/2" Dr. 6pt Deep Impact Socket
42332	1" 1/2" Dr. 6pt Deep Impact Socket
42334	1-1/16" 1/2" Dr. 6pt Deep Impact Socket
42336	1-1/8" 1/2" Dr. 6pt Deep Impact Socket
42338	1-3/16" 1/2" Dr. 6pt Deep Impact Socket
42340	1-1/4" 1/2" Dr. 6pt Deep Impact Socket
42342	1-5/16" 1/2" Dr. 6pt Deep Impact Socket
42344	1-3/8" 1/2" Dr. 6pt Deep Impact Socket
42346	1-7/16" 1/2" Dr. 6pt Deep Impact Socket
42348	1-1/2" 1/2" Dr. 6pt Deep Impact Socket

1/2 in. Drive Metric Deep Impact Socket Sets

- Chrome-moly constructed for durability
- Laser etched size markings for easy identification
- Radius corner design reduces fastener wear
- Heavy duty blow molded storage case



Part #		UPC	Master	Inner
42404	14-PC MM	8-02090-42404-5	4	1

42404 SET CONTENTS

Part #	Description
42410	10mm 1/2" Dr. 6pt Deep Impact Socket
42411	11mm 1/2" Dr. 6pt Deep Impact Socket
42412	12mm 1/2" Dr. 6pt Deep Impact Socket
42413	13mm 1/2" Dr. 6pt Deep Impact Socket
42414	14mm 1/2" Dr. 6pt Deep Impact Socket
42415	15mm 1/2" Dr. 6pt Deep Impact Socket
42416	16mm 1/2" Dr. 6pt Deep Impact Socket
42417	17mm 1/2" Dr. 6pt Deep Impact Socket
42418	18mm 1/2" Dr. 6pt Deep Impact Socket
42419	19mm 1/2" Dr. 6pt Deep Impact Socket
42421	21mm 1/2" Dr. 6pt Deep Impact Socket
42422	22mm 1/2" Dr. 6pt Deep Impact Socket
42426	26mm 1/2" Dr. 6pt Deep Impact Socket
42427	27mm 1/2" Dr. 6pt Deep Impact Socket

Part #		UPC	Master	Inner
42406	26-PC MM	8-02090-42406-9	2	1

42406 SET CONTENTS

Part #	Description
42410	10mm 1/2" Dr. 6pt Deep Impact Socket
42411	11mm 1/2" Dr. 6pt Deep Impact Socket
42412	12mm 1/2" Dr. 6pt Deep Impact Socket
42413	13mm 1/2" Dr. 6pt Deep Impact Socket
42414	14mm 1/2" Dr. 6pt Deep Impact Socket
42415	15mm 1/2" Dr. 6pt Deep Impact Socket
42416	16mm 1/2" Dr. 6pt Deep Impact Socket
42417	17mm 1/2" Dr. 6pt Deep Impact Socket
42418	18mm 1/2" Dr. 6pt Deep Impact Socket
42419	19mm 1/2" Dr. 6pt Deep Impact Socket
42420	20mm 1/2" Dr. 6pt Deep Impact Socket
42421	21mm 1/2" Dr. 6pt Deep Impact Socket
42422	22mm 1/2" Dr. 6pt Deep Impact Socket
42423	23mm 1/2" Dr. 6pt Deep Impact Socket
42424	24mm 1/2" Dr. 6pt Deep Impact Socket
42425	25mm 1/2" Dr. 6pt Deep Impact Socket
42426	26mm 1/2" Dr. 6pt Deep Impact Socket
42427	27mm 1/2" Dr. 6pt Deep Impact Socket
42428	28mm 1/2" Dr. 6pt Deep Impact Socket
42429	29mm 1/2" Dr. 6pt Deep Impact Socket
42430	30mm 1/2" Dr. 6pt Deep Impact Socket
42432	32mm 1/2" Dr. 6pt Deep Impact Socket
42433	33mm 1/2" Dr. 6pt Deep Impact Socket
42434	34mm 1/2" Dr. 6pt Deep Impact Socket
42435	35mm 1/2" Dr. 6pt Deep Impact Socket
42436	36mm 1/2" Dr. 6pt Deep Impact Socket

1/2 in. Drive 6 pt. SAE Impact Sockets

- Chrome-moly constructed for durability
- Laser etched size markings for easy identification



Part #	Size (in.)	UPC	Master	Inner
42312	3/8	8-02090-42312-3	48	6
42314	7/16	8-02090-42314-7	48	6
42316	1/2	8-02090-42316-1	48	6
42318	9/16	8-02090-42318-5	48	6
42320	5/8	8-02090-42320-8	48	6
42322	11/16	8-02090-42322-2	48	6
42324	3/4	8-02090-42324-6	48	6
42326	13/16	8-02090-42326-0	48	6
42328	7/8	8-02090-42328-4	48	6
42330	15/16	8-02090-42330-7	48	6
42332	1	8-02090-42332-1	48	6
42334	1-1/16	8-02090-42334-5	48	6
42336	1-1/8	8-02090-42336-9	48	6
42340	1-1/4	8-02090-42340-6	48	6

1/2 in. Drive 6 pt. Metric Impact Sockets

- Chrome-moly constructed for durability
- Laser etched size markings for easy identification



Part #	Size (mm)	UPC	Master	Inner
42410	10	8-02090-42410-6	48	6
42411	11	8-02090-42411-3	48	6
42412	12	8-02090-42412-0	48	6
42413	13	8-02090-42413-7	48	6
42414	14	8-02090-42414-4	48	6
42415	15	8-02090-42415-1	48	6
42416	16	8-02090-42416-8	48	6
42417	17	8-02090-42417-5	48	6
42418	18	8-02090-42418-2	48	6
42419	19	8-02090-42419-9	48	6
42421	21	8-02090-42421-2	48	6
42422	22	8-02090-42422-9	48	6
42424	24	8-02090-42424-3	48	6
42426	26	8-02090-42426-7	48	6
42427	27	8-02090-42427-4	48	6
42430	30	8-02090-42430-4	48	6
42432	32	8-02090-42432-8	48	6

8 pc. 3/4 in. Drive Deep Impact Socket Sets

- Chrome-moly constructed for durability
- Laser etched size markings for easy identification
- Radius corner design reduces fastener wear
- Heavy duty blow molded storage case



Part #		UPC	Master	Inner
44300	SAE	8-02090-44300-8	2	1

44300 SET CONTENTS

Part #	Description
44334	1-1/16" 3/4" Dr. 6pt Deep Impact Socket
44336	1-1/8" 3/4" Dr. 6pt Deep Impact Socket
44340	1-1/4" 3/4" Dr. 6pt Deep Impact Socket
44342	1-5/16" 3/4" Dr. 6pt Deep Impact Socket
44344	1-3/8" 3/4" Dr. 6pt Deep Impact Socket
44346	1-7/16" 3/4" Dr. 6pt Deep Impact Socket
44348	1-1/2" 3/4" Dr. 6pt Deep Impact Socket
44332	1" 3/4" Dr. 6pt Deep Impact Socket



Part #		UPC	Master	Inner
44600	Metric	8-02090-44600-9	2	1

44600 SET CONTENTS

Part #	Description
44826	26mm 3/4" Dr. 6pt Deep Impact Socket
44827	27mm 3/4" Dr. 6pt Deep Impact Socket
44829	29mm 3/4" Dr. 6pt Deep Impact Socket
44830	30mm 3/4" Dr. 6pt Deep Impact Socket
44832	32mm 3/4" Dr. 6pt Deep Impact Socket
44835	35mm 3/4" Dr. 6pt Deep Impact Socket
44836	36mm 3/4" Dr. 6pt Deep Impact Socket
44838	38mm 3/4" Dr. 6pt Deep Impact Socket

3/4 in. Drive Impact Extension Bars

- Chrome-moly constructed for durability
- Laser etched size markings for easy identification



Part #	Length (in.)	UPC	Master	Inner
44003	4	8-02090-44003-8	24	12
44008	6	8-02090-44008-3	24	12
44010	10	8-02090-44010-6	12	6
44013	13	8-02090-44013-7	12	6

3/4 in. Drive Universal Joint 44130

- Chrome-moly constructed for durability
- Laser etched size markings for easy identification



UPC	Master	Inner
8-02090-44130-1	12	6

3/4 in. Adapters

- Chrome-moly constructed for durability
- Laser etched size markings for easy identification

Part #	Size (in.)	UPC	Master	Inner
42358	3/4 F x 1 M	8-02090-42358-1	48	6
42357	3/4 F x 1/2 M	8-02090-42357-4	48	6



1 in. Drive Deep Impact Socket Sets

- Chrome-moly constructed for durability
- Laser etched size markings for easy identification
- Radius corner design reduces fastener wear
- Heavy duty blow molded storage case



Part #	UPC	Master	Inner
40309	9 pc SAE	8-02090-40309-5	2 1

40309 SET CONTENTS

Part #	Description
40332	1" 1" Dr. 6pt Deep Impact Socket
40336	1-1/8" 1" Dr. 6pt Deep Impact Socket
40340	1-1/4" 1" Dr. 6pt Deep Impact Socket
40344	1-3/8" 1" Dr. 6pt Deep Impact Socket
40348	1-1/2" 1" Dr. 6pt Deep Impact Socket
40352	1-5/8" 1" Dr. 6pt Deep Impact Socket
40356	1-3/4" 1" Dr. 6pt Deep Impact Socket
40360	1-7/8" 1" Dr. 6pt Deep Impact Socket
40364	2" 1" Dr. 6pt Deep Impact Socket



Part #	UPC	Master	Inner
41908	8 pc Metric	8-02090-41908-9	2 1

41908 SET CONTENTS

Part #	Description
40927	27mm 1" Dr. 6pt Deep Impact Socket
40930	30mm 1" Dr. 6pt Deep Impact Socket
40932	32mm 1" Dr. 6pt Deep Impact Socket
40933	33mm 1" Dr. 6pt Deep Impact Socket
40935	35mm 1" Dr. 6pt Deep Impact Socket
40936	36mm 1" Dr. 6pt Deep Impact Socket
40938	38mm 1" Dr. 6pt Deep Impact Socket
40941	41mm 1" Dr. 6pt Deep Impact Socket

MORE SOCKET FOR MORE TORQUE!



TITAN 1" Drive Impact Sockets & Adapters

Made for the BIG job!

*Impact gun not offered

1 in. F x 3/4 in. M Reducing Adapter 42359

- Chrome-moly constructed for durability
- Laser etched size markings for easy identification
- 1"F to 3/4"M



UPC	Master	Inner
8-02090-42359-8	36	6

1 in. Drive Impact Extension Bars

- Chrome-moly constructed for durability
- Laser etched size markings for easy identification



Part #	Length (in.)	UPC	Master	Inner
40144	4	8-02090-40144-2	12	6
40146	6	8-02090-40146-6	12	6
40150	10	8-02090-40150-3	12	6
40153	13	8-02090-40153-4	12	6

TORSION CORE™

HI-SPEC ALLOY for 3X Bit Life

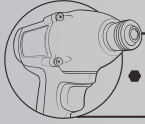

**IMPACT
GRADE**

Patented design reduces stripping of fasteners

Dual-property alloy ensures bit sockets will withstand high torque for easier removal of stubborn fasteners

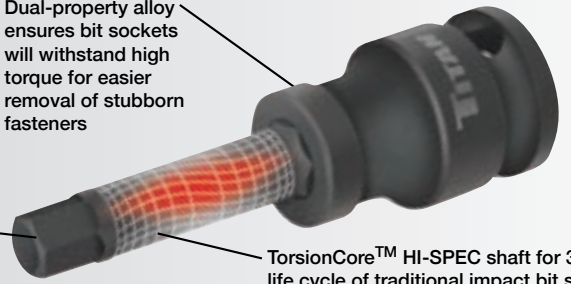

TorsionCore™ HI-SPEC shaft for 3X the life cycle of traditional impact bit sockets

Impact Bit Socket Set

- Designed for easier removal of stubborn fasteners

42925



42906



44101



44505



42977



Part #	Piece Count	Drive Size (in.)	Fastener Type	Sizes Included	UPC	Master	Inner
42925	5	1/2	Hex Bit SAE	1/4", 5/16", 3/8", 7/16", 1/2"	8-02090-42925-5	24	6
42906	6	1/2	Hex Bit Metric	7mm, 8mm, 9mm, 10mm, 12mm, 14mm	8-02090-42906-4	12	6
44101	4	3/4	Hex Bit SAE	3/4", 11/16", 5/8", 9/16"	8-02090-44101-1	12	1
44505	5	3/4	Hex Bit Metric	15 mm, 16 mm, 17 mm, 18 mm, 19 mm	8-02090-44505-7	10	1
42977	7	1/2	Star Bit	T30, T40, T45, T50, T55, T60, T70	8-02090-42977-4	18	6

3 pc. Reducing Impact Adapter Set **12036**

- 3/4" F x 1/2" M, 1/2" F x 3/8" M,
- 3/8" F x 1/4" M
- Impact Grade
- Chrome-moly constructed for durability
- Includes blow mold case



UPC	Master	Inner
8-02090-12036-7	12	6

3 pc. Low Profile Adapter Set **30936**

- Detent ball design
- Chrome-moly constructed for durability
- Set Includes:
- 1/2" F to 3/4" M
- 3/8" F to 1/2" M
- 1/4" F to 3/8" M

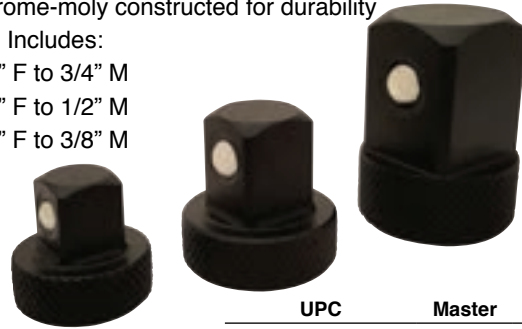

UPC	Master	Inner
8-02090-30936-6	72	24

8 pc. Impact Socket Adapter Set **40000**

- Chrome-moly constructed for durability
- Laser etched size markings for easy identification
- Heavy duty blow molded storage case
- Includes: (8) Adapters: 1 Inch F x 3/4 Inch M, 3/4 Inch F x 1/2 Inch M, 1/2 Inch F x 3/8 Inch M, 3/8 Inch F x 1/4 Inch M, 1/4 Inch F x 3/8 Inch M, 3/8 Inch F x 1/2 Inch M, 1/2 Inch F x 3/4 Inch M, 3/4 Inch F x 1 Inch M



UPC	Master	Inner
8-02090-40000-1	8	4

9 pc. Assorted Impact Extension Bar Set **40109**

- Set includes: (3) 1/4" Drive: 2, 4, & 6", (3) 3/8" Drive: 1-3/4", 3, & 6", (3) 1/2" Drive: 3, 5, & 10"
- Chrome-moly constructed for durability
- Laser etched size markings for easy identification



UPC	Master	Inner
8-02090-40109-1	12	6

3 pc. Impact Socket Universal Joint Set 40160

- Set includes: 1/2, 1/4, and 3/8"
- Chrome-moly constructed for durability
- Laser etched size markings for easy identification

UPC	Master	Inner
8-02090-40160-2	48	6



40160 SET CONTENTS

Part #	Description
46130	1/4" Dr. Impact Universal Joint
48130	3/8" Dr. Impact Universal Joint
42130	1/2" Dr. Impact Universal Joint

5 pc. Pin-Free Impact Locking Universal Joint Adapter Set 16150

- Chrome-moly constructed for durability
- Laser etched size markings for easy identification

UPC	Master	Inner
8-02090-16150-6	24	6



16150 SET CONTENTS

Part #	Description
46157	1/4" to 3/8" Dr. Pin Free Impact Locking U-Joint
48159	3/8" to 1/2" Dr. Pin Free Impact Locking U-Joint
48158	3/8" to 1/2" Dr. Pin Free Impact Locking U-Joint
42157	1/2" to 3/8" Dr. Pin Free Impact Locking U-Joint
42158	1/2" to 3/4" Dr. Pin Free Impact Locking U-Joint

3 pc. Pin-Free Locking Impact Universal Joint Set 16151

- Chrome-moly constructed for durability
- Includes storage tray

UPC	Master	Inner
8-02090-16151-3	24	6



16151 SET CONTENTS

Part #	Description
46158	1/4" Dr. Pin Free Impact Locking U-Joint
48160	3/8" Dr. Pin Free Impact Locking U-Joint
42160	1/2" Dr. Pin Free Impact Locking U-Joint

11-Amp 7 in. Polisher Sander 22530

- UL Certified
- Rated voltage: 120V, 60Hz
- Variable speed 1000-3000 RPM
- Auxiliary handle mounts either side for left or right-hand use
- Set Includes: (1) Polisher/Sander, (1) Hook and Loop Pad, (1) Straight Auxiliary Handle, (1) D-Handle, (1) Polishing Bonnet, (1) Rubber Pad, (1) Spanner Wrench & (1) Polishing Pad Arbor



UPC	Master	Inner
8-02090-22530-7	4	1

Replacement Motor Brushes 22512

- Replacement Motor brushes for the #22530 Vaper Polisher/Sander



UPC	Master	Inner
8-02090-22512-3	100	1

Flange and Wrench Set 22511

- Replacement Flange Nut & Wrench for VAPER items #22507
- Fits other models of polishers and grinders with 5/8" -11 spindle threads

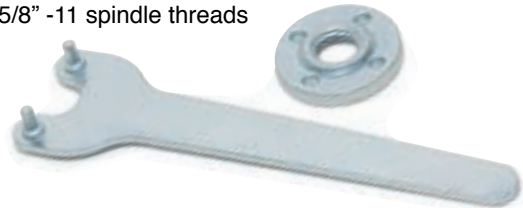

UPC	Master	Inner
8-02090-22511-6	36	6

7 in. Replacement Rubber Polishing Pad 22508

- For use on 7" polisher and sander
- Replacement rubber pad for Vaper item 22507
- 7" rubber pad
- Fits a 5/8"-11 spindle thread

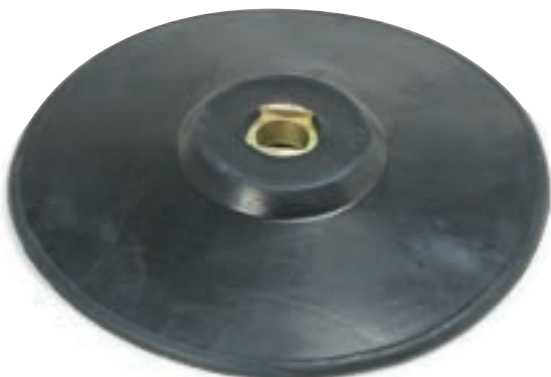

UPC	Master	Inner
8-02090-22508-6	25	1

7 in. Replacement Hook and Loop Sanding Pad 22509

- For use on 7" polisher and sander
- Replacement hook & loop pad for Vaper item 22507
- 7" velcro pad
- Fits a 5/8"-11 spindle thread



UPC	Master	Inner
8-02090-22509-3	25	1

6 in. Random Orbital Buffer/Polisher 22606

- ETL Certified
- Powerful 0.40 Amp, 3500 RPM motor
- Random action reduces paint burn-through
- Lightweight for easy one-hand operation
- Includes 1 terry cloth and 1 synthetic wool pads
- Volts: 120VAC ~ 60HZ



UPC	Master	Inner
8-02090-22606-9	6	1

2 pc. 6 in. Replacement Bonnets 22502

- For use on" buffers and polishers
- Includes terry-cloth bonnet for applying waxes and 1 synthetic wool bonnet for fine buffing and polishing



UPC	Master	Inner
8-02090-22502-4	100	10

10 in. Orbital Electric Polisher 22610

- ETL Certified
- Powerful 0.92 Amp, 3000 RPM motor
- Random action reduces paint burn-through
- Lightweight with large, comfortable handles
- Volts: 120VAC ~ 60HZ
- Includes (1) terry cloth bonnet & (1) synthetic wool bonnet



UPC	Master	Inner
8-02090-22610-6	6	1

2 pc. 10 in. Replacement Bonnets 22501

- For use on 10" buffers and polishers
- Includes 1 terrycloth bonnet for applying waxes and 1 synthetic wool bonnet for fine buffing and polishing



UPC	Master	Inner
8-02090-22501-7	50	5

Heat Gun 22400

- ETL Certified
- 12.5 Amps 120V Heat Gun
- Ideal for plastic welding shrink tubing and paint stripping
- Dual temperature setting
- 3 position rocker switch: off, high, & low
- Durable ABS body
- Double insulated
- 6-1/2 ft cord
- Rated Power: Low Setting 750W, High Setting 1500W
- Blowing Speed: Low Setting: 10CFM (280 L/min), High Setting: 17CFM (480 L/min)
- Temperature: Low Setting: 572 degrees, High Setting: 932 degrees



UPC	Master	Inner
8-02090-22400-3	10	1

3/8 in. Keyless Chuck Adapter 16207

- 1/4" Hex Shank
- 3/8" Keyless Chuck conversion for 1/4" impact driver



UPC	Master	Inner
8-02090-16207-7	72	6

Right-Angle Drill Attachment 16235

- 90 Degree 1/4" Bit Driver
- 360 Degree Swivel Handle
- 1/4" Hex Shank
1/4" Chuck Bit Holder
Smooth precision turning during 90 degree position



UPC	Master	Inner
8-02090-16235-0	48	6

3 pc. Damaged Screw Extractor Set 11215

- Includes (3) Double sided extractors: #1: Screw Size 4-7, SAE Bolt Size 7-32", MM Bolt Size 5mm, #2: Screw Size 8-10, SAE Bolt Size 1/4", MM Bolt Size 6mm, #3: Screw Size 11-14, SAE Bolt Size 5/16", MM Bolt Size 8mm
- For use with removing size 4-14 screws and bolts up to 5/16"
- Double sided extractor tips remove stripped screws and bolts
- Drill out, flip bit and extract screw

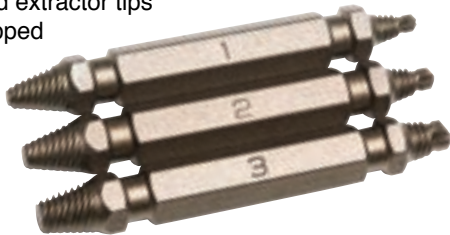

UPC	Master	Inner
8-02090-11215-7	144	12

10 pc. Screw Extractor/Left Hand Drill Bit 16013

- 5 pcs Multi-fluted, machined alloy steel screw extractor. Sizes #1-5
- Remove broken screws easily
- 5 pcs left-hand cobalt drill bits. Sizes: 5/64", 7/64", 5/32", 1/4", 19/64"
- Metal storage box included



UPC	Master	Inner
8-02090-16013-4	48	12

Step Drills

- Drill multiple sizes with each bit

Part #	Contents/Size	UPC	Master	Inner
16503 3-pc Set	Bit one: 13 sizes from 1/8" to 1/2"; Bit two: 6 sizes from 3/16" to 1/2"; Bit three: 9 sizes from 1/4" to 3/4"	8-02090-16503-0	72	12
16501	#1 Bit 1/8" - 1/2"	8-02090-16501-6	144	24
16504	#2 Bit 1/4" - 3/4"	8-02090-16504-7	144	24



5 pc. Hex Shank Drill Bit Set 16505

- Cobalt Steel bits for wood, plastic & metal
- Use with a bit holder or insert directly into a drill
- Sizes include: 1/16", 3/32", 1/8", 5/32" & 3/16"
- Convenient storage rack



UPC	Master	Inner
8-02090-16505-4	24	6

27 pc. Micro Drill Set with Driver 11003

- 27pc Set
Includes: (1) Micro Driver.
(2) Dual-End Collets (stored in handle) (24) Drill Bits (2 of each size) #52 (.0635), #54 (.0550), #56 (.0465), #58 (.0420), #60 (.0400), #62 (.0380) #64 (.0360), #66 (.0330), #68 (.0310), #70 (.0280) #72 (.0250), #74 (.0225)
- Great for a variety of drilling & cleaning uses such as:
- Fuel injectors, carburetor jets, welding & soldering torch tips, water jets, electronics service & repairs



UPC	Master	Inner
8-02090-11003-0	48	6

22 pc. Titanium Drill Bit 11006



- Titanium nitride coating extends the life of the bit up to six times longer than standard high speed steel drill bits
- Contains: 1/16, 5/64, 3/32, 7/64, 1/8, 9/64, 5/32, 11/64, 3/16, 13/64, 7/32, 15/64, 1/4, 17/64, 9/32, 19/64, 5/16, 21/64, 11/32, 23/64, 3/8"
- Includes plastic storage case

UPC	Master	Inner
8-02090-11006-1	36	6

170 pc. Titanium Coated Drill Bit Set 11170

- Titanium coated bits last up to six times longer than a normal bit
- Made of high speed steel for durability
- Includes convenient metal storage case
- 19 different drill bit sizes:
- (5 ea) 21/64, 23/64, 3/8, & 1/2
- (10 ea) 3/64, 1/16, 5/64, 3/32, 1/8, 9/64, 5/32, 11/64, 3/16, 7/32, 15/64, 1/4, 9/32, 19/64, & 5/16"

UPC	Master	Inner
8-02090-11170-9	5	1



29 pc. Titanium Coated Drill Bit Set 16530

- Sizes include: 1/16, 5/64, 3/32, 7/64, 1/8, 9/64, 5/32, 11/64, 3/16, 13/64, 7/32, 15/64, 1/4, 17/64, 9/32, 19/64, 5/16, 21/64, 11/32, 23/64, 3/8, 25/64, 13/32, 27/64, 7/16, 29/64, 15/32, 31/64 and 1/2 inch
- Reduced shank bits for use with 3/8" chuck
- 118° Standard point tips
- Titanium coating helps resist rust
- Made of high speed steel for added strength & durability
- Convenient storage case

UPC	Master	Inner
8-02090-16530-6	12	6



Quick-Release Extension Bit Holders

- Extra-long extended driver for hard to reach areas
- Auto locking drive
- Locking, magnetic, low profile, quick release bit holder



Part #	Length (in.)	UPC	Master	Inner
16020	2-1/4	8-02090-16020-2	250	25
16236	6	8-02090-16236-7	96	6
16006 Counter Display	6	8-02090-16006-6	120	20
16012	12	8-02090-16012-7	48	6
16018	18	8-02090-16018-9	48	6

Flexible Extension Bit Holder 16004

- Locking, magnetic, quick release bit holder
- 12x stronger magnet than standard bit holder
- Extended flexible driver for hard to reach areas
- Compress silver ring to insert and remove bit
- Designed to flex and hold at various angles
- For use with hand or power tool driver
- Maximum Extension 12"

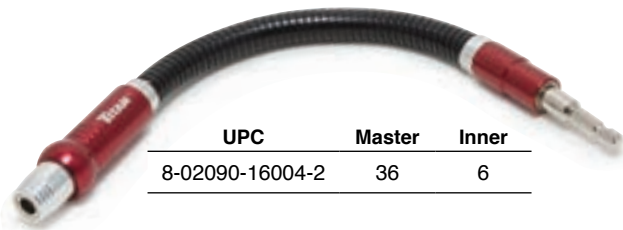

UPC	Master	Inner
8-02090-16004-2	36	6

Swivel Bit Holder 16227

- 2-Positioning Swivel Power Bit Holder, Chuck locking mechanism, Aluminum Sleeve for lock and unlock
- Swivel and straight position
- 30 degree swivel angle

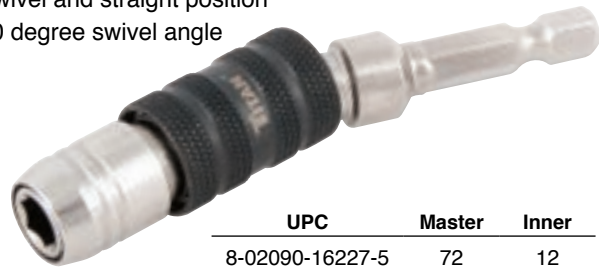

UPC	Master	Inner
8-02090-16227-5	72	12

45 pc. Bit Kit 16044

16044 SET CONTENTS

- | | |
|----------------------------------|-----------------------------------|
| (14) 50mm Power screwdriver bits | (7) Power nut drivers: |
| ■ SQ1 & SQ2 | 7/32, 1/4, 9/32, 5/16, 3/8, |
| ⊖ 3/16 & 1/4" | 7/16 & 1/2" |
| ● 1/8, 5/32, 3/16 & 1/4" | (5) High speed steel |
| ★ T10, T15, T20, T25, | quick-disconnect drill bits: |
| T30 & T40 | 1/16, 3/32, 1/8, 5/32 & 3/16" |
| (2) 100mm Power screwdriver bits | (1) 1/4" Hex to 1/4" Square |
| ⊗ (2) #2 | socket adapter |
| (5) 65mm Double ended | (1) 2-1/2" magnetic bit extension |
| Screwdriver bits | (2) 10 bits capacity belt clips |
| ⊗ #2, #2 & #3 | (1) 4 bit capacity bit holder |
| ■ SQ1 & SQ2 | (1) Convenient storage case |
| (5) 110mm Double ended | |
| screwdriver bits: | |
| ■ (3) #2 | |
| ⊗ (2) SQ2 | |

UPC	Master	Inner
8-02090-16044-8	12	6

148 pc. Master Security Bit Set
16148



- Assortment of the most popular and hard-to-find bits for many different applications
- Contains Phillips, Slotted, Square, Star, Pozi, SAE Hex, Metric Hex, Tamper Resistant Star, Tamper Resistant Hex, Clutch, Spline, Spanner, Tri-wing and Quad-Wing drive bits
- Includes 3-1/2" magnetic bit holder, quick-release bit holder and 1/4" driver socket adapter
- Injection molded storage case

UPC	Master	Inner
8-02090-16148-3	12	1

16148 SET CONTENTS

- (70) 25mm Bits
- ⊖ 2, 2.5, 3, 3.5, 4, 4.5, 5, 5.5, 6, 6.6, 7, 8mm
 - ⊗ #00, #0, #1, #2, #2, #2, #3, #4
 - ⊗ #00, #0, #1, #2, #2, #2, #3, #4
 - 1.5, 2, 2.5, 3, 3.5, 4, 4.5, 5, 5.5, 6, 7, 8mm
 - 1/16", 5/64", 3/32", 7/64", 1/8", 9/64", 5/32", 3/16", 7/32", 1/4"
 - ⊕ T5, T6, T7, T8, T9, T10, T15, T20, T25, T27, T30, T40, T45
 - ⊖ M5, M6, M8
 - 0, 1, 2, 3
- (13) 25mm Bits
- ⊗ #2, #3; (3)
 - ⊗ #1, #2, #3
 - ⊕ T10, T15, T20, T25, T27, T30, T40
 - 2
- (13) 75mm Bits
- ⊗ #1, #2, #2, #2, #3
 - 1, 2, 2, 2, 3; (2)
 - 3/16", 1/4"
 - ⊖ 1/4"
- (25) Security Bits
- ⊕ 6, 8, 10
 - ⊖ 4, 6, 8, 10
 - ⊕ 1, 2, 3, 4
 - ⊗ TX10, 15, 20, 25, 27, 30, 40, 45, 50
 - ⊕ T5H, T6H, T7H, T8H, T9H, T10H, T15H, T20H, T25H, T27H, T30H, T35H, T40H, T45H
 - 2, 2.5, 3, 4, 5, 6
 - 5/64", 3/32", 7/64", 1/8", 9/64", 5/32"
 - ⊗ 1, 2, 3
- (1) 60mm Bit Holder (Stainless)
- (1) Quick Release #2 Bit Holder
- (1) 1/4" x 1/4" Socket Adapter

100 pc. Security Bit Set 16100

16100 SET CONTENTS

- SQ0, SQ1, SQ2, SQ3
- ⊗ #0, #1, (5) #2, #3
- ⊖ 3, 4, 4.5, 5, 5.5, 6, 6.5, 7, 8 mm
- ⊗ #0, #1, (5) #2, #3
- ⊕ T8, T10, T15, T20, T25, T27, T30, T40, T45
- ⊕ TR8, TR10, TR15, TR20, TR25, TR27, TR30, TR40, TR45
- 1/16, 5/64, 3/32, 7/64, 1/8, 9/64, 5/32, 3/16, 7/32, 1/4"
- 1.5, 2, 2.5, 3, 4, 5, 5.5, 6, 8 mm
- 5/64, 3/32, 7/64, 1/8, 9/64, 5/32"
- 2, 2.5, 3, 4, 5, 6 mm
- Clutch: #1, #2, #3
- Spline: M5, M6, M8
- ⊖ Spanner: 4, 6, 8, 10
- Four Wing: 6, 8, 10
- ⊕ Tri Wing: 1, 2, 3, 4
- (1) 2-1/2" Magnetic bit extension
- (1) 2-1/4" Hex to 1/4" square adapter
- (1) 1-1/4" Hex to 1/4" square adapter
- (1) 1/4" Square to 1/4" hex adapter
- (1) 1/4" Hex wingnut driver
- (1) Blow mold case



UPC	Master	Inner
8-02090-16100-1	20	10

2 pc. 2-1/2 in. Fits-All-Phillips Bit Set **16240**

- Patented, precision ground tip design fits a variety of screw sizes
- Chrome plated S2 Alloy steel shaft has fits-all-Phillips on one end and 1/4" slotted at other end



UPC	Master	Inner
8-02090-16240-4	96	24

2 in. Power Bits

- Forged bit for better fit and longer life
- 3 times longer bit life
- 2 inch length



Part #	Size	UPC	Master	Inner
16210 2-pc	#2 Phillips	8-02090-16210-7	400	20
16230 2-pc	1/4" Slotted	8-02090-16230-5	400	20

6 in. Power Bits

- Forged bit for better fit and longer life
- 3 times longer bit life
- 6 inch length



Part #	Size	UPC	Master	Inner
16211 2-pc	#2 Phillips	8-02090-16211-4	96	24
16231 2-pc	1/4" Slotted	8-02090-16231-2	96	24
16221 2-pc	#2 Square	8-02090-16221-3	96	24



2 pc. #2 Square Drive 2 in. Power Bits **16220**

- Forged bit for better fit and longer life
- 2" #2 Square Bit
- S2 material



UPC	Master	Inner
8-02090-16220-6	400	20

8 pc. Magnetic Bit Holder With Bits **16008**

- Spinning finger grip for increased control
- 12 times stronger magnet than standard bit holder
- Easy one handed operation
- Retract collar to install or remove bits
- 3,000 RPM max
- Use with insert bits only, bit sizes include: PH: #1, #2, #3, Square: S1 & S2, Slotted: 6-8 & 8-10
- Includes bit holder



UPC	Master	Inner
8-02090-16008-0	48	6

3 pc. 1/4 in. Shank Magnetic Nut Setter 16103

- Magnetic nut driver
- Chrome vanadium construction
- 2.5" x 1/4" shank
- Sizes include: 1/4", 5/16", 3/8"



UPC	Master	Inner
8-02090-16103-2	75	15

3 pc. 6 in. 1/4 in. Shank Magnetic Nut Setter 16106

- Magnetic nut driver
- Chrome vanadium construction
- 6" x 1/4" shank
- Sizes include: 1/4", 5/16", 3/8"



UPC	Master	Inner
8-02090-16106-3	75	15

Magnetic Bit Holder Display 16021

- Spinning finger grip for increased control
- 12 times stronger magnet than standard bit holder
- Easy one handed operation
- Retract collar to install or remove bits
- 3,000 RPM max
- Use with insert bits only
- Ships in 25pc Fishbowl display



UPC	Master	Inner
8-02090-16021-9	250	25

Magnetic Nut Setter Displays

- Manganese phosphate
- Impact grade
- Ships in a 50pc fish bowl display

Part #	Size	Length	UPC	Master	Inner
16184	1/4 in.	1-5/8 in.	8-02090-16184-1	500	50
16185	5/16 in.	1-5/8 in.	8-02090-16185-8	500	50
16186	3/8 in.	1-3/4 in.	8-02090-16186-5	500	50
16187	1/2 in.	1-3/4 in.	8-02090-16187-2	500	50
16188	9/16 in.	2-5/8 in.	8-02090-16188-9	500	50



2-1/2 in. Double End Torsion Bit Displays

- Manganese phosphate
- Impact grade
- Ships in a 50pc fish bowl display

Part #	Size	UPC	Master	Inner
16178	PH2	8-02090-16178-0	500	50
16179	S2	8-02090-16179-7	500	50
16180	T10	8-02090-16180-3	500	50
16181	T15	8-02090-16181-0	500	50
16182	T20	8-02090-16182-7	500	50
16183	T25	8-02090-16183-4	500	50



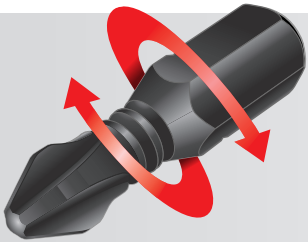

TORSION FLEX DESIGN™

The Torsion Flex Design™ feature allows the torsion section of the bit to flex under load and take pressure off of the bit tip for increased durability in high torque applications.



50 pc. Torsion Impact Bit Set 16251

16251 SET CONTENTS

- ⊗ PH2x (2), PH2x5", PH3x2" (2)
- S2x2", S3x2"
- 4mm, 5mm, 5.5mm, 6mm, 8mm
- 5/32", 3/16", 7/32", 1/4", 5/16"
- ★ T10, T15, T20, T25, T27, T30, T40
- ★ 5" Bits: T25, T27, T30, T40
- 5" with Ball Tip: 4mm, 5mm, 5.5mm, 6mm, 8mm
- 5" with Ball Tip: 5/32", 3/16", 7/32", 1/4", 5/16"
- ⊖ 6/8x2"
- Adapters: 1/4x1/4", 1/4"x3/8"
- 2-3/4" Adapters: 1/4"x1/2"
- 6" Adapters: 1/4"x1/4", 1/4"x 3/8"
- Chucks: 1/4"x2-1/2", 1/4"x6"
- 2-1/2" Socket Drivers: 1/4", 3/8", 5/16"

UPC	Master	Inner
8-02090-16251-0	10	1



33 pc. Impact Bit Set 16073

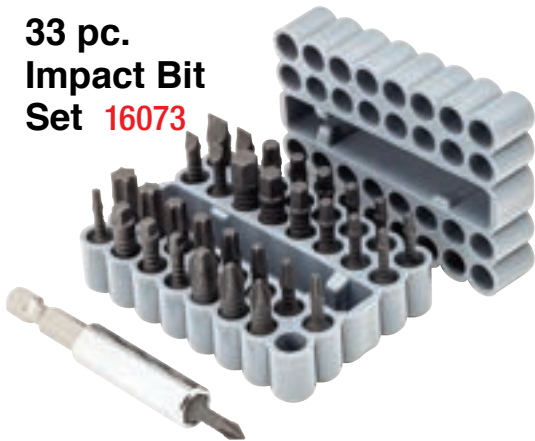

- Set includes:
 - (4) Phillips: PH0, PH1, PH2 & PH3
 - (4) Slotted: 1/8, 5/32, 3/16 & 1/4"
 - (9) Star: T8, T9, T10, T15, T20, T25, T27, T30 & T40
 - (3) Square: S1, S2 & S3
 - (6) MM Hex: 2, 2.5, 3, 4, 5 & 6 mm
 - (6) SAE Hex: 5/64, 3/32, 7/64, 9/64, 1/8 & 5/32"
 - (1) 2-1/2" Magnetic bit holder
- Specially designed for impact drills & drivers
- Torsion design prolongs bit life & protects fasteners
- Shock absorbing torsion design allows bit to flex under impact

UPC	Master	Inner
8-02090-16073-8	72	12

5 pc. 2 in. PH2 Impact Bit Set 16075

- Specially designed for impact drills & drivers
- Torsion design prolongs bit life & protects fasteners
- Shock absorbing torsion design allows bit to flex under impact
- Works with JIS screws



UPC	Master	Inner
8-02090-16075-2	360	24

2 pc. 6 in. PH2 Impact Bit Set 16074

- Specially designed for impact drills & drivers
- Torsion design prolongs bit life & protects fasteners
- Shock absorbing torsion design allows bit to flex under impact
- Works with JIS screws



UPC	Master	Inner
8-02090-16074-5	360	24



Impact Bit Sets

- Torsion bits reduce damage to fastener
- Convenient storage rail



Torx Plus



SAE



TR STAR



METRIC

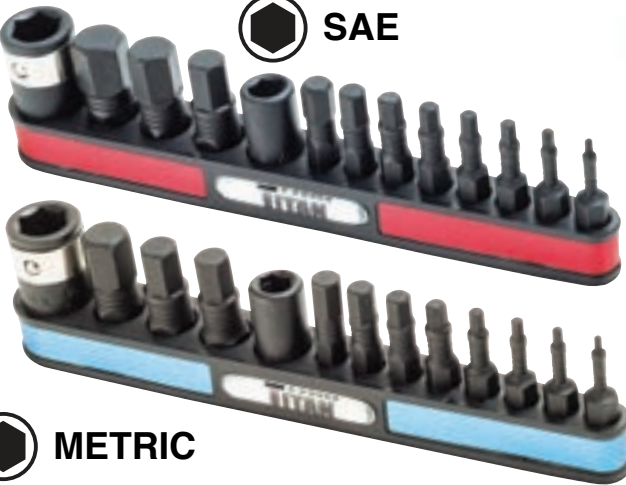

Part #	Contents	UPC	Master	Inner
16036 13-pc Torx Plus	1/4" Shank hex bits: TP8, TP10, TP15, TP20, TP25, TP27, TP30 and TP40 3/8" Shank hex bits: TP45, TP50 and TP55 1/4" and 3/8" drive bit holders	8-02090-16036-3	48	6
16037 13-pc SAE	1/4" Shank hex bits - 1/16", 3/32", 1/8", 9/64", 5/32", 3/16", 7/32" & 1/4" 3/8" Shank hex bits - 5/16", 3/8" & 7/16" 1/4" and 3/8" drive bit holders	8-02090-16037-0	48	6
16038 13-pc MM	1/4" Shank hex bits - 1.5, 2, 2.5, 3, 4, 5, 5.5 & 6mm 3/8" Shank hex bits - 7, 8 & 10mm 1/4" and 3/8" drive bit holders	8-02090-16038-7	48	6
16039 13-pc TR Star	1/4" Shank hex bits - TR8, TR10, TR15, TR20, TR25, TR27, TR30 & TR40 3/8" Shank hex bits - TR45, TR50 & TR55 1/4" and 3/8" drive bit holders	8-02090-16039-4	48	6

2 pc. 2 in. Magnetic Driver Bit 16234

- 2 Inch long Impact Bit with Magnet
- Size: PH2 x 2pcs
- Material: S2
- Manganese phosphate finish



UPC	Master	Inner
8-02090-16234-3	144	12

2 pc. #2 Phillips 6 in. Power Bit Set 16215

- Includes (2) 6" #2 Phillips Bit

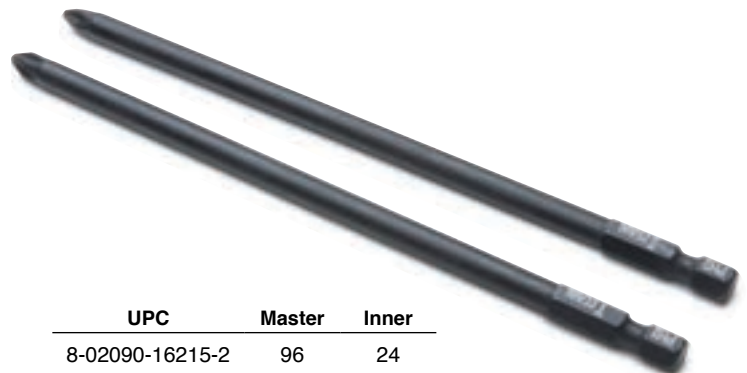

UPC	Master	Inner
8-02090-16215-2	96	24

5 pc. 1 in. Impact Grade #2 PH Power Bit Set 16205

- 5 Piece Phillips #2- 1" Power Bits
- Material: S2



UPC	Master	Inner
8-02090-16205-3	72	24

2 pc. 2 in. Impact #2 PH Power Bit Set 16206

- Includes (2) 2" #2 Phillips bits
- Fits standard 1/4" hex drivers



UPC	Master	Inner
8-02090-16206-0	72	24



3 pc. 1 in. Impact Bit Sets

- 1" overall length

Part #	Contents	UPC	Master	Inner
16228	Phillips: #1, #2, #2	8-02090-16228-2	144	48
16229	Phillips: #2, #2, #3	8-02090-16229-9	144	48

10 pc. 2 in. Impact Bit Set

- 2" overall length

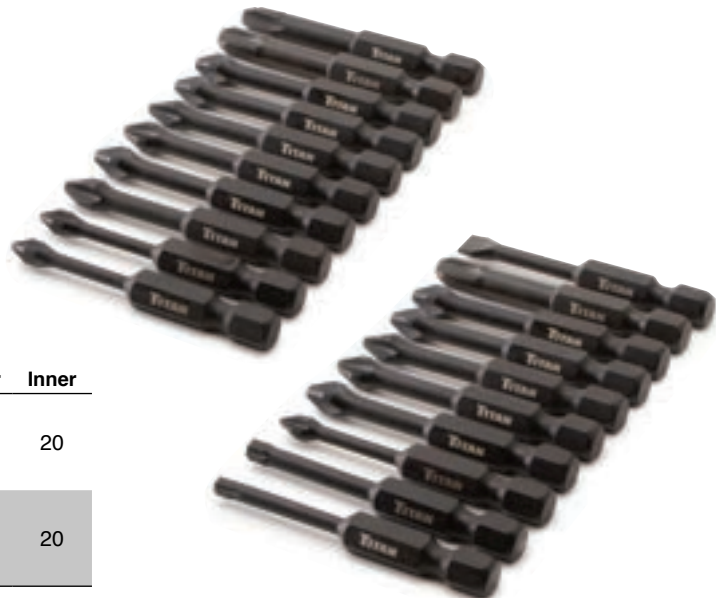
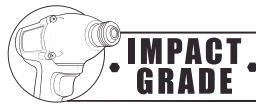

Part #	Contents	UPC	Master	Inner
16232	Phillips: #1, (5) #2, (1) #3 Slotted: 1/4" Star: T15	8-02090-16232-9	60	20
16233	Phillips: (2) #1, (6) #2, (2) #3	8-02090-16233-6	60	20

6 pc. 6 in. Impact Nut Driver Set

- 1/4" Shank
- Color ring for easy size identification
- Overall length: 6"

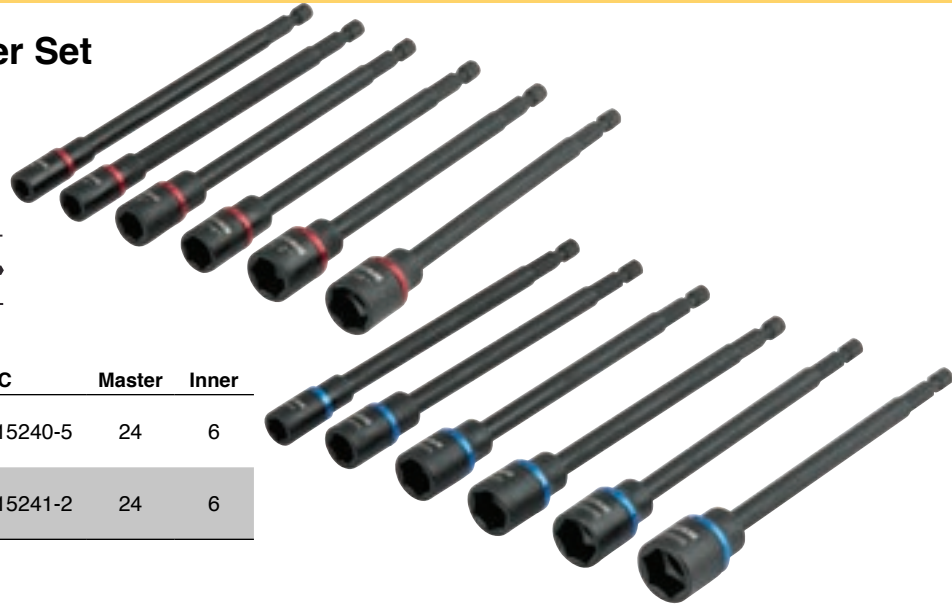
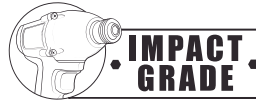

Part #	Contents	UPC	Master	Inner
15240	1/4, 5/16, 3/8, 7/16, 1/2, and 9/16 inch	8-02090-15240-5	24	6
15241	8, 10, 12, 13, 14, 15 mm	8-02090-15241-2	24	6



Easy Read Nut Driver Set

- 1/4" Shank
- Color-coded rings for easy identification
- Includes storage rail
- Overall length: 2-1/4"

Part #	Contents	UPC	Master	Inner
15222	1/4, 5/16, 3/8, 7/16, 1/2, & 9/16"	8-02090-15222-1	48	6
15223	8, 10, 12, 13, 14, & 15mm	8-02090-15223-8	48	6

Nut Driver Sets

- 1/4" hex shank fits any standard drill chuck
- Includes storage rail
- Overall length: 2-1/4"



Part #	Contents	UPC	Master	Inner
15220	1/4", 5/16", 3/8", 7/16" and 1/2"	8-02090-15520-8	48	6
15221	8, 10, 12, 13, 14mm	8-02090-15221-4	48	6

1/4 in. Hex Shank Magnetic Bit Holder

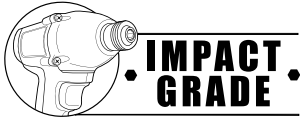

- 1/4 in. hex shank for 1/4 in. hex inserts
- Stainless steel magnetic bit holder
- S2 steel shank



Part #	Size (in.)	UPC	Master	Inner
16002	3	8-02090-16002-8	240	24
16005	6	8-02090-16005-9	240	24

Impact Adapter Sets

- Detent ball for secure socket retention
- Adapts sockets to power drills and drivers
- 1/4" shank

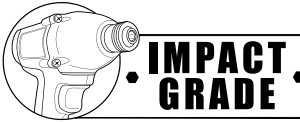

Part #	Piece Count	Contents	UPC	Master	Inner
12089	9 Piece	1/4 Inch Drive: 2-1/2 in. (65 mm), 6 in. (150 mm) & 12 in. (305 mm) 3/8 Inch Drive: 2-1/2 in. (65 mm), 6 in. (150 mm) & 12 in. (305 mm) 1/2 Inch Drive: 2-3/4 in. (72 mm), 6 in. (150 mm) & 12 in. (305 mm)	8-02090-12089-3	12	1
12087	6 Piece	1/4 Inch Drive: 2-1/2 in. (65 mm) & 6 in. (150 mm) 3/8 Inch Drive: 2-1/2 in. (65 mm) & 6 in. (150 mm) 1/2 Inch Drive: 2-3/4 in. (72 mm) & 6 in. (150 mm)	8-02090-12087-9	48	12
12082	3 Piece	1/4 Inch Drive: 2-1/2 in. (65 mm) 3/8 Inch Drive: 2-1/2 in. (65 mm); 1/2 Inch Drive: 2-3/4 in. (72 mm)	8-02090-12082-4	120	20
12086	3 Piece	1/4 Inch Drive: 6 in. (150 mm) 3/8 Inch Drive: 6 in. (150 mm); 1/2 Inch Drive: 6 in. (150 mm)	8-02090-12086-2	72	12
15206	3 Piece	1/4 Inch Drive: 12 in. (305 mm) 3/8 Inch Drive: 12 in. (305 mm); 1/2 Inch Drive: 12 in. (305 mm)	8-02090-15206-1	36	6

Wobble Impact Adapter Sets

- Wobble feature for 30° range of motion
- Detent ball for secure socket retention
- Adapts sockets to power drills and drivers
- 1/4" shank

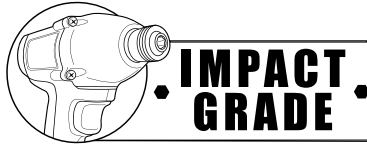

Part #	Piece Count	Contents	UPC	Master	Inner
49089	9 Piece	1/4 Inch Drive: 2-1/2 in. (65 mm), 6 in. (150 mm) & 12 in. (305 mm) 3/8 Inch Drive: 2-1/2 in. (65 mm), 6 in. (150 mm) & 12 in. (305 mm) 1/2 Inch Drive: 2-3/4 in. (72 mm), 6 in. (150 mm) & 12 in. (305 mm)	8-02090-49089-7	12	1
49036	6 Piece	1/4 Inch Drive: 2-1/2 in. (65 mm) & 6 in. (150 mm) 3/8 Inch Drive: 2-1/2 in. (65 mm) & 6 in. (150 mm) 1/2 Inch Drive: 2-3/4 in. (72 mm) & 6 in. (150 mm)	8-02090-49036-1	48	12
49003	3 Piece	1/4 Inch Drive: 2-1/2 in. (65 mm) 3/8 Inch Drive: 2-1/2 in. (65 mm) 1/2 Inch Drive: 2-3/4 in. (72 mm)	8-02090-49003-3	120	20
49006	3 Piece	1/4 Inch Drive: 6 in. (150 mm) 3/8 Inch Drive: 6 in. (150 mm) 1/2 Inch Drive: 6 in. (150 mm)	8-02090-49006-4	72	12
49012	3 Piece	1/4 Inch Drive: 12 in. (305 mm) 3/8 Inch Drive: 12 in. (305 mm) 1/2 Inch Drive: 12 in. (305 mm)	8-02090-49012-5	36	6

Locking Socket Adapter

- Detent ball for secure socket retention
- Adapts sockets to power drills and drivers
- Insert into socket, socket locks into place, pull back to release



Part #	Contents/Size	UPC	Master	Inner
15214 3-pc	6" x 1/4" drive, 6" x 3/8" drive & 6" x 1/2" drive	8-02090-15214-6	48	6
15210 3-pc	2-3/4" x 1/4" drive, 2-3/4" x 3/8" drive & 2-3/4" x 1/2" drive	8-02090-15210-8	72	6
15211	2-3/4" x 1/4" drive	8-02090-15211-5	144	12

Part #	Contents/Size	UPC	Master	Inner
15212	2-3/4" x 3/8" drive	8-02090-15212-2	144	12
15213	2-3/4" x 1/2" drive	8-02090-15213-9	144	12
15215	6 x 1/4" drive	8-02090-15215-3	96	12
15216	6" x 3/8" drive	8-02090-15216-0	96	12
15217	6" x 1/2" drive	8-02090-15217-7	96	12

Quick Change Impact Adapter

- Converts square drive impact wrench to hex drive
- Quick release collar
- Chrome Moly construction

Part #	Contents/Size	UPC	Master	Inner
12034	3/8" Sq. to 1/4" hex	8-02090-12034-3	100	20
12039	1/2" Sq. to 1/4" hex	8-02090-12039-8	100	20



Air Tools, Spray Guns & Hoses

AIR TOOLS

SPRAY GUNS

AIR HOSES

AIR HOSE
ACCESSORIES

AIR PUMPS
& GAUGES



High Quality Construction

Stainless Steel Nozzles

Premium quality rubber, PVC
and Hybrid blended hoses

1/2 in. Drive Impact Wrench 19748

- Free running speed: 7,000 rpm
- 230 ft/lb torque
- 4 speed regulator
- Air inlet: 1/4in NPT
- Suggested air compressor: 2 HP
- Suggested air hose size: 3/8in
- Suggested air pressure: 90 PSI
- Air consumption: 5-10 CFM
- Comfortable impact resistant grip
- Ergonomic trigger



UPC	Master	Inner
8-02090-19748-2	10	1

3/8 in. Drive Air Ratchet Wrench 19732

- Forward/Reverse lever conveniently located for quick direction changes
- Light-weight composite body
- Ideal for quickly spinning nuts and bolts on or off, removal and installation of spark plugs and other engine parts such as water pumps, radiators, etc
- 3/8" Square Drive
- Bolt Size Capacity: 1/2"
- Free Speed RPM: 160
- Working Torque: 50 Ft-lb (68 N.m)
- Overall Length: 10.8" (275mm)
- Air Inlet: 1/4"
- Air Hose: 3/8"
- Average Air Consumption: 3cfm (85.5 l/min)
- Net Weight: 2.5lbs (1.15kgs)



UPC	Master	Inner
8-02090-19732-1	20	1

3/8 in. Drive Air Ratchet 19749

- Free running speed: 160 rpm
- Max torque: 50 ft/lbs
- Air inlet: 1/4in NPT
- Suggested air compressor: 1 HP
- Suggested air hose: 3/8in
- Suggested air pressure: 90 PSI
- Drive: 3/8in
- Air consumption: 2.7 CFM



UPC	Master	Inner
8-02090-19749-9	10	1

19 pc. Air Tool Kit 19699

- Includes:
- 3/8" ratchet
- 1/2" Impact Wrench
- 1/2" Impact Sockets: 1/2", 9/16", 5/8", 11/16"
- 10mm, 12mm, 15mm, 17mm, 19mm
- 3/8" F to 1/2"M Impact Socket Adapter
- 3" 3/8" Impact Extension
- 1/4" NPT Male Industrial Plugs (2)
- Air Tool Oil
- Carry Case



UPC	Master	Inner
8-02090-19699-7	5	1

3 in. Air Cut-Off Tool 19746

- No load speed: 18,000 rpm
- Air inlet: 1/4in NPT
- Average air consumption: 4cfm
- Suggested air compressor: 2 HP
- Suggested air pressure: 90 PSI
- Cut-off wheel size: 3in
- Suggested air hose size: 3/8in
- Includes (1) cutting disc



UPC	Master	Inner
8-02090-19746-8	10	1

1/4 in. 6 mm Angle Die Grinder 19715

- Grinder cap: 1/4" (6MM)
- High speed (20,000 RPM) for maximum production
- Air inlet (NPT): 1/4"
- Air hose: 3/8" diameter
- Average air consumption: 2.2CFM (62.7L/MIN)
- Rear exhaust
- Angle head provides easy access into tight space
- Used with a variety of accessories for grinding, edge-breaking, beblurring, and polishing



UPC	Master	Inner
8-02090-19715-4	20	1

5 in. Mini Air Die Grinder 19737

- Mini and compact design with industrial level quality
- Durable, composite and lightweight body
- Ergonomic pistol grip with low-noise design
- Variable speed trigger for maximum control
- Free Speed: 18,000 RPM
- Chuck Capacity: 6 mm (1/4")
- Power: 0.28 KW (0.38 HP)
- Air Inlet 1/4"
- Handle Exhaust
- Air Consumption: 76 LPM (2.7 CFM)
- Noise LpA / LwA : 75.6 DB / 86.6 DB
- Vibration: 6.58 m/s²
- Length: 5"
- Net Weight: 1.1 lbs



UPC	Master	Inner
8-02090-19737-6	10	1

5-1/2 in. Mini Orbital Sander 19735



- Mini and compact design with industrial level quality
- Durable, composite and lightweight body
- Ergonomic pistol grip with low-noise design
- Variable speed trigger for maximum control
- Free Speed: 18,000 RPM
- Includes 3" Pad
- Orbit Diameter: 3.0 mm (1/8")
- Spindle Size : 5/16"-24
- Power: 0.28 KW (0.38 HP)
- Air Inlet: 1/4"
- Air Hose ID: 3/8"
- Air Consumption: 76 LPM (2.7 CFM)
- Noise LpA / LwA : 77.2 / 88.2 DB
- Vibration: 7.19 m/s²
- Length: 5.5"
- Net Weight: 1.3 lbs
- Replacement Pad #01356

UPC	Master	Inner
8-02090-19735-2	10	1

5 in. Mini Disc Sander 19736

- Mini and compact design with industrial level quality
- Durable, composite and lightweight body
- Ergonomic pistol grip with low-noise design
- Variable speed trigger for maximum control
- Free Speed: 18,000 RPM
- Includes 3" Pad
- Spindle Size : 1/4"-20
- Power: 0.28 KW (0.38 HP)
- Air Inlet: 1/4"
- Air Hose ID: 3/8"
- Air Consumption: 76 LPM (2.7 CFM)
- Noise LpA / LwA :: 78.1 / 89.1 DB
- Vibration: 2.5 m/s²
- Length: 5.1"
- Net Weight: 0.53 kgs (1.2 lbs)
- Replacement Pad #01357



UPC	Master	Inner
8-02090-19736-9	10	1



6 in. Orbital Sander 19225

- Low profile design with ergonomic grip
- Random orbital action assures a swirl-free finish
- Variable air speed control
- 5mm orbit for rapid material removal
- 6" diameter premium urethane vinyl face pad
- Applications include pre-paint preparation, sanding, feather edging, and touch-up work

UPC	Master	Inner
8-02090-19225-8	10	1

Sand Blaster 19450

- Includes: Hopper, Aluminum Blast Gun, 15ft Material Hose
- Use with an air compressor to remove rust, paint, graffiti, corrosion & scale
- Compatible with any abrasive: silica, sand, steel grit, glass beads & pecan shells
- Gravity feed for constant flow of blasting material
- Operating pressure: 90 PSI
- Minimum air requirement: 3.5 CFM @ 50 PSI
- Hopper capacity: 50 lbs
- Nozzle size: 3/16"
- Air Inlet: 1/4" NPT
- Replacement nozzle part # 19451



UPC	Master	Inner
8-02090-19450-4	2	1

3 pc. Dual Setup HVLP Spray Gun Kit 19100

- Set includes:
- 1.4mm needle and nozzle set for lighter materials
- 1.7mm needle and nozzle set for heavier materials
- Locking Pressure regulator with gauge
- Features and specs:
- 1000 ml aluminum paint cups
- Spray pattern control knob on side of guns
- Air Inlet: 1/4"
- Operating pressure: 15 - 45 P.S.I.
- Avg. Air consumption: 7.0 - 9.0 C.F.M.
- Stainless steel nozzles



UPC	Master	Inner
8-02090-19100-8	5	1

3 pc. HVLP Spray Gun Kit 19219

- Gun A - 1.0 mm for touch up work
- Gun B - 1.4 mm for bases and clear coats
- Locking pressure regulator with gauge
- Aluminum paint cups
- Die cast aluminum body with chrome plated finish
- 2-Step trigger control
- Non-bleeder type, gravity feed external mix
- Stainless steel nozzles
- Adjustable spray width, air inlet and fluid outlet



UPC	Master	Inner
8-02090-19219-7	5	1

4 pc. HVLP Triple Setup Spray Gun Kit 19220

- Aluminum paint cups
- Die cast aluminum body with chrome plated finish
- 2-Step trigger control
- Non-bleeder type, gravity feed external mix
- Stainless steel nozzles
- Adjustable spray width, air inlet and fluid outlet
- Locking pressure regulator with gauge
- Set Includes: (1) 1.0 mm detail gun, (1) 1.4 mm top-coat gun & (1) 1.7 mm primer gun



UPC	Master	Inner
8-02090-19220-3	5	1

4 pc. HVLP Triple Setup Spray Gun Kit 19221

- Locking pressure regulator with gauge
- Aluminum storage/carry case
- Aluminum paint cups
- 2-Step trigger control
- Non-bleeder type, gravity feed external mix
- Stainless steel nozzles
- Adjustable spray width, air inlet and fluid outlet
- Set Includes: (1) 1.0 mm detail gun, (1) 1.4 mm topcoat gun & (1) 1.7 mm primer gun

UPC	Master	Inner
8-02090-19221-0	3	1



4 pc. HVLP Dual Setup Spray Gun Kit 19223

- Versatile spray gun kit includes:
- Gun A - 1.4 mm production gun
- Gun B - 1.7mm production gun
- Locking pressure regulator with gauge
- 6" Random orbital sander for paint prep and finishing applications
- Mesh filters for gravity feed paint cups
- 2 spray gun wrenches
- Cleaning brush
- Stainless steel nozzles

UPC	Master	Inner
8-02090-19223-4	3	1

3 pc. Dual Set Up HVLP Spray Gun Kit 19800

- Set includes:
- 1.4mm needle and nozzle set for lighter materials
- 1.7mm needle and nozzle set for heavier materials
- Locking Pressure regulator with gauge
- Features and specs:
- 1000 ml aluminum paint cups
- Spray pattern control knob on side of guns
- Air Inlet: 1/4"
- Operating pressure: 15 - 45 P.S.I.
- Avg. Air consumption: 7.0 - 9.0 C.F.M.

UPC	Master	Inner
8-02090-19800-7	5	1



1.4 mm HVLP Gravity Feed Production Spray Gun **19014**

- Gravity feed design provides for easy clean up and reliable performance
- Unlike siphon feed guns, gravity feed guns ensure virtually 100% material usage
- Lightweight aluminum paint cup, Stainless steel needle and nozzle set resists corrosion and wear from abrasive materials
- Infinitely adjustable fluid control for precise paint metering
- Spray pattern control allows adjustment from round to full-fan shape
- Air valve for precise air flow adjustment
- Includes pressure regulator and cleaning kit



UPC	Master	Inner
8-02090-19014-8	10	1

HVLP Gravity Feed Spray Guns

- Stainless steel needle
- Locking pressure regulator with gauge
- 600cc plastic paint cup



Part #	Tip Size (mm)	UPC	Master	Inner
19000 BLUE	1.4	8-02090-19000-1	10	1
19018 RED	1.8	8-02090-19018-6	10	1
19023 GREEN	2.3	8-02090-19023-0	10	1

Deluxe Gravity Feed HVLP Spray Guns

- Includes locking pressure regulator with gauge
- 1000 ml capacity aluminum paint cup
- Spray pattern control knob on side of guns
- Stainless steel nozzles
- Air Inlet: 1/4"
- Operating pressure: 15 - 45 P.S.I.
- Average air consumption: 7.0 - 9.0 C.F.M.

Part #	Tip Size (mm)	UPC	Master	Inner
19113	1.3	8-02090-19113-8	5	1
19114	1.4	8-02090-19114-5	5	1
19117	1.7	8-02090-19117-6	5	1
19120	2.0	8-02090-19120-6	5	1
19123	2.3	8-02090-19123-7	5	1



1.0 mm HVLP Gravity Feed Touch Up Gun **19110**

- 1.0 mm touch up gun
- 100 cc Aluminum paint cup
- Stainless steel nozzle
- Ships in reusable storage tray
- Includes cleaning kit with maintenance tools

UPC	Master	Inner
8-02090-19110-7	5	1

Dual Action Gravity Feed Airbrush **19551**

- Nozzle Size: 0.2mm
- Paint Capacity: 9cc
- Operating Pressure: 14.5-50.75 PSI
- Paint Distance: 6" (150mm)
- Paint Width: 1-3/8" (35mm)
- Air Consumption: 0.15 CFM
- Air Inlet: 1/4" NPT
- Balanced, lightweight design with chrome plated finish
- Dual action trigger for greater control - press down for air; pull back for paint
- For use with automotive or water based paints



UPC	Master	Inner
8-02090-19551-8	20	1

2-quart Spray Gun Kit 19610

- High Pressure Gun with Tank
- 2-quart Paint Cup with Regulator
- Max. Working Pressure : 70PSI
- Cup Pressure : Not Exceed 10 PSI with 1/4" Fitting
- Paint (Black) hose with 3/8" Fitting
- Built-in pressure Regulator
- Replacement tank available, part #01099



UPC	Master	Inner
8-02090-19610-2	4	1

1.8 mm Siphon Feed Production Spray Gun 19418

- Fully adjustable spray pattern
- 1.8 mm needle and nozzle set for heavier materials
- Non bleeder type, siphon feed
- External mix for fine atomization
- Spun aluminum 1 liter canister



UPC	Master	Inner
8-02090-19418-4	10	1

Siphon Feed Detail Spray Gun 19417

- Fully Adjustable Nozzle
- 1.5 mm Fluid Nozzle
- 200 ml Cup capacity
- Great for detailing, touch up & small repair work



UPC	Master	Inner
8-02090-19417-7	10	1



Spot Spray Non-Aerosol Sprayers

- Colored sprayers for convenient recognition
- Refillable
- ECO friendly
- Eliminates dangerous or harmful propellants
- 80-150psi operating pressure
- Not for use with paint products or flammable propellants
- Rebuild Kit Available #19420

Part #		UPC	Master	Inner
19421	TWIN PACK	8-02090-19421-4	10	1
19424	BLUE	8-02090-19424-5	20	1
19419	RED	8-02090-19419-1	20	1

Spot Spray Rebuild Kit 19420

- Includes everything but the canister

UPC	Master	Inner
8-02090-19420-7	50	1

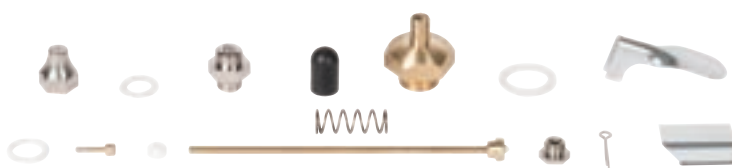



HYBRID FLEX AIR HOSE

VAPER Hybrid Flex Air Hoses are made from a premium blend of rubber and PVC which allows for both a lightweight yet flexible hose. Zero memory also allowing it to lay flat exactly where you drop it and won't work against you during operation or coiling after use.

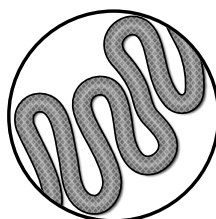

**ULTRA
 FLEXIBLE**

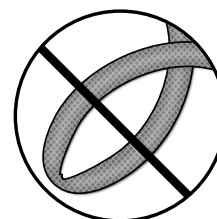

**KINK
 RESISTANT**

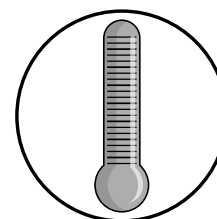

-40° F to 140° F

Item#	Hose Length	Hose Diameter	NPT (M)	Working Pressure	UPC	Master	Inner
19484	25'	1/4"	1/4"	300 PSI	8-02090-19484-9	16	1
19485	50'	1/4"	1/4"	300 PSI	8-02090-19485-6	8	1
19486	100'	1/4"	1/4"	300 PSI	8-02090-19486-3	4	1
19464	25'	3/8"	1/4"	300 PSI	8-02090-19464-1	16	1
19465	50'	3/8"	1/4"	300 PSI	8-02090-19465-8	8	1
19466	100'	3/8"	1/4"	300 PSI	8-02090-19466-5	4	1

1/4 in. x 25 ft. Polyurethane Recoil Air Hose **19368**

- Polyurethane Recoil Eng
- Swivel ends
- Swivel action brass nozzle keeps hose free of kinks
- Oil proof and abrasion, corrosion resistant
- 1/4" NPT brass fittings

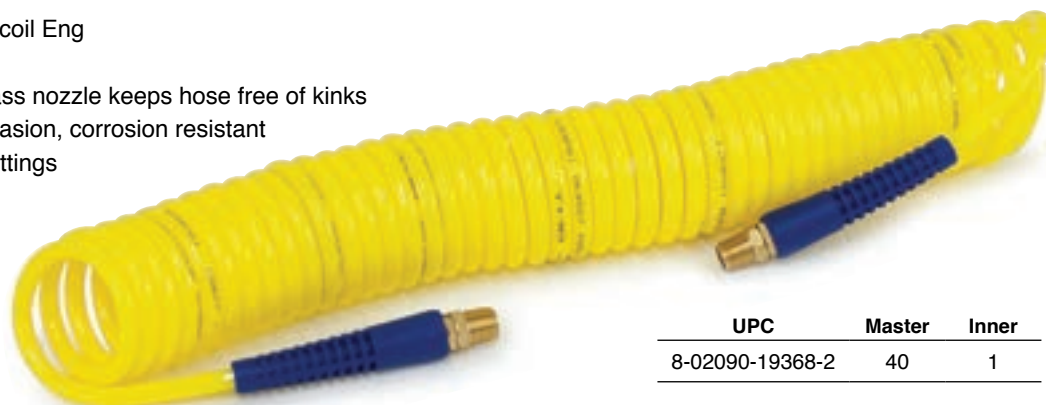

UPC	Master	Inner
8-02090-19368-2	40	1



Air Hoses

- Working Pressure: 300psi
- Burst Pressure: 1,200psi
- 3/8" Brass Fittings
- Vinyl Kink Restrictors

19371 PVC



19375 Rubber



19382 Rubber



Part #	Material	Color	Size	NPT (IN.)	UPC	Master	Inner
19469	PVC	Blue	3/8 in. x 25 ft.	1/4	8-02090-19469-6	16	1
19371	PVC	Blue	3/8 in. x 50 ft.	3/8	8-02090-19371-2	6	1
19375	Rubber	Black	3/8 in. x 35 ft.	3/8	8-02090-19375-0	5	1
19376	Rubber	Black	3/8 in. x 50 ft.	3/8	8-02090-19376-7	5	1
19382	Rubber	Red	3/8 in. x 50 ft.	1/4	8-02090-19382-8	6	1

Mini Air Compressor 22958

- Great for use with .2mm to 1.0mm Air Brushes
- Quiet 1/6 HP motor
- This compressor has an auto start and stop feature for consistent air flow
- Oil less with single cylinder Compressor
- 1450-1700rpm Speed
- Air output: 20-23 L/min
- Auto start: 43psi (3 bar)
- Auto stop: 57psi (4 bar)
- Pressure range: 0-4BAR
- Includes adjustable air regulator for better air control and an easy-to-read gauge
- Includes convenient carrying handle
- Includes rubber feet to reduce compressor vibration

Airflow Regulator with Gauge 19359

- 2-1/2" diameter gauge reads 0 to 160psi and 0 to 11 bar
- Inlet size 1/4" NPT
- Fitting is constructed of brass
- Overall size: 2" long x 2" deep



UPC	Master	Inner
8-02090-19359-0	48	6

10 ft. Braided Air Hose 22959

- Fits VAPER brand 22958 and other mini air compressors with 1/8" & 1/4" NPT fittings
- Rubber material with braided nylon for added strength
- Working Pressure: 145PSI
- Burst Pressure: 217 PSI



UPC	Master	Inner
8-02090-22959-6	50	10



UPC	Master	Inner
8-02090-22958-9	6	1

3/8 in. Hose Ends 19346

- For use with 3/8" i.d. hose
- Includes (2) brass 1/4" NPT male barbed hose nipples and (2) hose clamps



UPC	Master	Inner
8-02090-19346-0	192	12

3/8 in. Hose Mender 19345

- For repair of 3/8" i.d. hose
- Includes (2) brass barbed hose splice fitting and (4) hose clamps



UPC	Master	Inner
8-02090-19345-3	192	12

1/4 in. Hose Mender Kit 19434

- For use with 1/4" i.d. hose
- Includes: (2) brass barbed hose splicers, (3) brass 1/4" NPT male barbed hose nipples, (4) hose clamps



UPC	Master	Inner
8-02090-19434-4	192	12

Double Male Connector 19361

- 1/4" NPT double male brass connector
- Overall length: 1"



UPC	Master	Inner
8-02090-19361-3	192	12

1/4 in. to 1/4 in. Coupling

- Inlet size: 1/4" NPT male
- Brass construction
- Overall length: 1"



Part #	Size	UPC	Master	Inner
19440	Male to Female	8-02090-19440-5	192	12
19441	Female to Female	8-02090-19441-2	192	12

Swivel Plug 19327

- Inlet size: 1/4" NPT male
- 30° Swivel action reduces fatigue by increasing mobility at the tool
- Swivel feature for easy access in confined spaces
- Overall length 2-1/4"



UPC	Master	Inner
8-02090-19327-9	192	12

Swivel Air Regulator/Connector 19369

- Swivel design for adaptability
- Thumbscrew control for air regulation
- Inlet size: 1/4" NPT
- Aluminum constructed

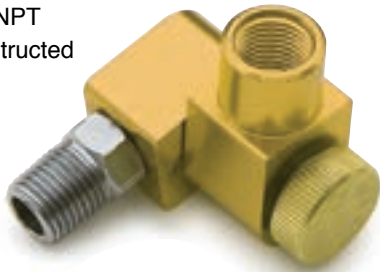

UPC	Master	Inner
8-02090-19369-9	144	12

360 Degree Swivel Connector 19444

- Reduces stress at hose connection points
- For use with 1/4" NPT fittings and quick connect adapters
- Swivels 360°



UPC	Master	Inner
8-02090-19444-3	240	10

1/4 in. NPT Tee Fitting 19439

- 3-Way brass T-connector
- Inlet size: 1/4" NPT
- Overall length: 1-3/4"



UPC	Master	Inner
8-02090-19439-9	192	12

In-Line Air Flow Regulator 19442

- Used to regulate air flow with thumbscrew valve control knob
- Inlet size: 1/4" NPT
- Brass constructed
- Overall length: 1-1/2"



UPC	Master	Inner
8-02090-19442-9	192	12

2-Way Swivel Splitter 19445

- Splits (1) 1/4" i.d. input air line into (2) 1/4" outlet couplers
- Allows connection of (2) tools to a single air supply
- 360° swivel feature reduces hose kinking
- Universal couplers for use with A, M, and T-style male plugs
- Steel constructed



UPC	Master	Inner
8-02090-19445-0	24	6

3-Way Swivel Splitter 19446

- Splits (1) input air line into (3) 1/4" outlet couplers
- Allows connection of (3) tools to a single air supply
- 360° swivel feature reduces hose kinking
- Universal couplers for use with A, M, and T-style male plugs
- Steel constructed



UPC	Master	Inner
8-02090-19446-7	24	4

7 pc. Blow Gun Kit 19337

- 7 pc. kit includes a zinc-alloy body blow gun with a steel trigger
- Accessories include 6 attachments: 3-3/4" extension, Rubber tip, Sports ball inflater plus adapter, inflatable toy inflater plus safety adapter



UPC	Master	Inner
8-02090-19337-8	48	6

8 pc. Blow Gun Kit 19436



- Kit includes:
(1) 3-5/8" long blow gun constructed of zinc-alloy body and steel trigger, (1) 3/4" long rubber tip, (1) 1-1/8" long air screen tip, (1) Brass tip, (1) Safety tip, (1) Adjustable tip, (1) 1-1/4" long nylon tip, (1) 7/8" long safety booster tip
- Inlet size: 1/4" NPT female

UPC	Master	Inner
8-02090-19436-8	48	6

Extended Offset Blow Guns

- Zinc-alloy body, steel trigger and a 24" long 30-degree angled aluminum nozzle with rubber tip
- Nozzle o.d.: 0.50"
- Air inlet: 1/4" NPT female
- Working pressure: 90 psi
- Maximum working pressure: 150 psi
- Rubber tip replacement: Titan item #01113

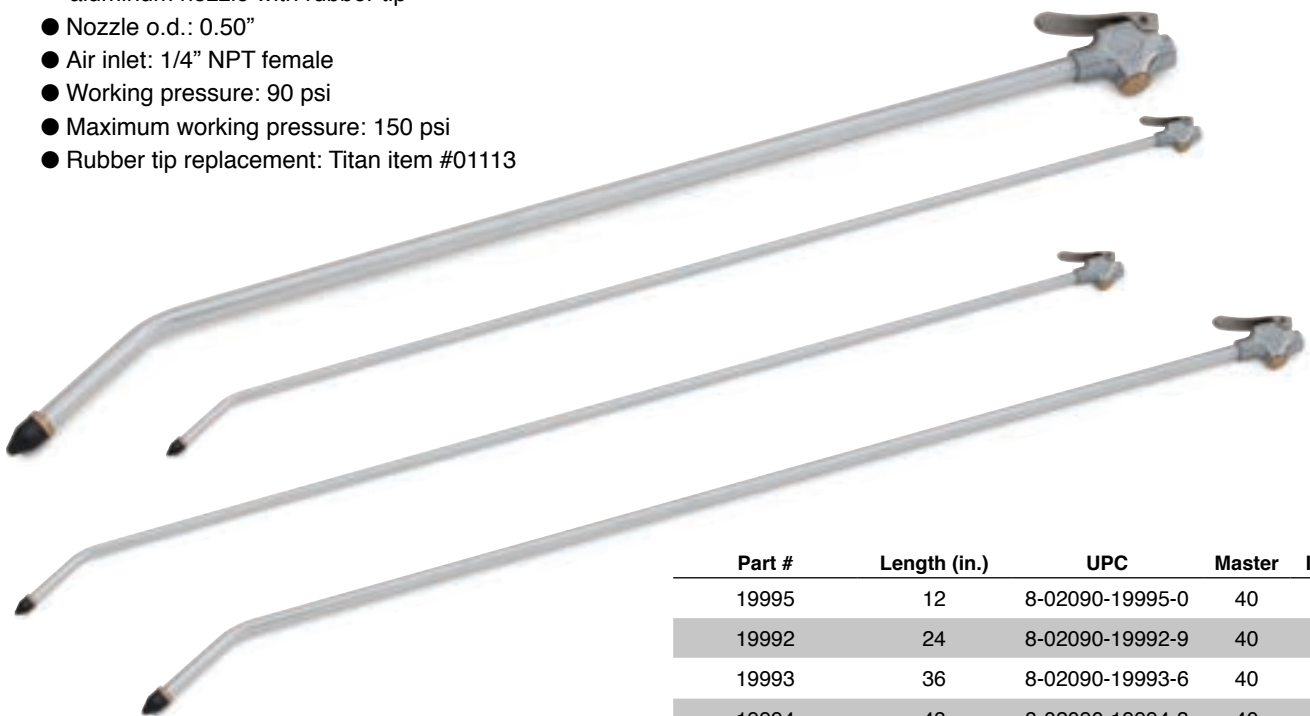

Part #	Length (in.)	UPC	Master	Inner
19995	12	8-02090-19995-0	40	10
19992	24	8-02090-19992-9	40	10
19993	36	8-02090-19993-6	40	10
19994	48	8-02090-19994-3	40	10

6 in. Blow Gun 19996

- Zinc-alloy body, steel trigger and a 6" straight aluminum nozzle with rubber tip
- Nozzle o.d.: 0.50"
- Air inlet: 1/4" NPT female
- Working pressure: 90 psi
- Maximum working pressure: 150 psi
- Overall length: 9"
- Rubber tip replacement: Titan item# 01113



UPC	Master	Inner
8-02090-19996-7	40	10

Rubber Tipped Blow Gun 19435

- Rubber tipped blow gun for use with air hose
- Overall length 4-3/4"
- Air inlet is 1/4" NPT female
- Body constructed of zinc-alloy



UPC	Master	Inner
8-02090-19435-1	96	6

Inline Blow Gun 19378

- 1/4" NPT female inline blow gun with rubber tip and push button air actuator
- Overall body length: 1-1/2"



UPC	Master	Inner
8-02090-19378-1	48	8

Turbo Venturi Mini Blow Gun 19405

- Venturi feature increases airflow by 3x
- Working pressure: No more than 90 psi
- Overall length 4-1/4"
- Air inlet thread: 1/4" NPS
- Air outlet tip thread: 1/8" NPS
- Air consumption: 6.5 CFM
- Air blow: 13 CFM
- Sound level: 88 dB



UPC	Master	Inner
8-02090-19405-4	120	10

Safety Tip Mini Blow Gun 19404

- Overall length: 3-1/4"
- Working Pressure: No more than 90 psi
- Push-button air activation
- Air inlet thread: 1/4" NPS
- Tip thread: 1/8" NPS
- Air consumption: 7.5CFM
- Air blow: 7.3 CFM
- Sound level: 73 dB
- OSHA compliant



UPC	Master	Inner
8-02090-19404-7	120	10

Pocket Blow Gun 19380

- Lightweight aluminum construction
- Twist-action adjustable valve for better air flow control
- For use with 1/4" I/M industrial couplers
- Recommended operating pressure: 90 psi
- Maximum Pressure: 120 psi
- Includes handy pocket clip
- Overall length 4-1/4"



UPC	Master	Inner
8-02090-19380-4	96	12



4 pc. Air Blow Gun Set 19391

- Set includes: (1) 4" Air blow gun, (3) Rubber Tip Nozzles: 9/16", 15/16" and 1-3/8"
- Seals and blows out clogged lines/pipes
- Rubber tips for use with sensitive surfaces
- Suitable for pressurizing, with leakage or cylinder testing
- Variable pressure control
- OSHA compliant safety tip
- Working pressure: 75-120psi
- Sound Pressure: 85-90dB
- Air Inlet Thread: 1/4" NPT

UPC	Master	Inner
8-02090-19391-0	48	12

Blow Gun with Removable Venturi Tip 19402

- Venturi Tip allows for 4X the airflow
- Lightweight and durable
- 1/4" NPT
- Working pressure: 90 to 120 psi / 6.0 to 8.0 kg
- Max pressure: 220 psi / 15 kg
- Sound pressure: 90 to 92 dB
- Air consumption (90 psi): 1/4" Hose-13
- CFM-350L/min 3
- 8" Hose-15 CFM-430 L/min
- Air inlet thread: SAE Size (1/4" NPT), MM Size (1/4" PT)



UPC	Master	Inner
8-02090-19402-3	36	6

Pistol Grip Nylon Blow Guns

- Variable air pressure control
- OSHA compliant safety nozzle
- Nozzle diameter: .25" o.d.
- Working pressure: 75 to 120 psi
- Sound Pressure: 85 to 90 db
- Inlet fitting size: 1/4" NPT female
- Allows for quick removal of dust and dirt particles from hard to reach places
- Durable plastic body and nozzle



Part #	Length (in.)	UPC	Master	Inner
19381	2 Piece Set	8-02090-19381-1	40	10
19360	4	8-02090-19360-6	48	12
19387	20	8-02090-19387-3	48	12
19388	30	8-02090-19388-0	40	10
19389	40	8-02090-19389-7	40	10

Double Barrel Foot Pump 19741

- Includes sports needle, tapered adapter & Presta valve adapter
- Works with Schrader & Presta valves
- Double barrel design allows for fast, high volume inflation
- Units of Measure: PSI & Bar
- 0-100PSI (0-7Bar) Pressure gauge
- Molded foot pedal & padded feet for added stability
- Easy to use foot operated pump for inflating bicycle tires, sports
- 21-1/4in. Air hose with locking tip
- Convenient clips hold pump in the closed position for easy storage



UPC	Master	Inner
8-02090-19741-3	12	1

Foot Pump 19745

- Easy-To-Use
- Foot Operated
- 180° Swivel Hose
- 3.5" Pressure Gauge
- Anti-Tip Base
- Presta to Schrader valve adapter stored in lever
- (1) Sports Needle & Adapter Stored Inside of Unit
- For Use With: Inflating car/bicycle tires, sports balls & air mattresses



UPC	Master	Inner
8-02090-19745-1	12	1

4 pc. Inflator Kit 19356

- Use to inflate tires, air mattresses and sports equipment
- Includes inflation adapter, tapered inflation nozzle, inflation needle, and tire nozzle



UPC	Master	Inner
8-02090-19356-9	96	24

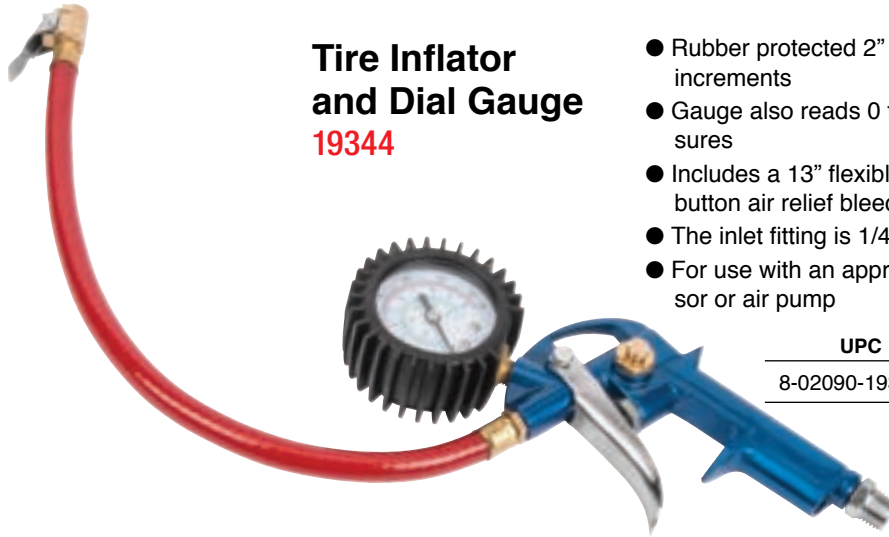

Tire Inflator and Dial Gauge
19344

- Rubber protected 2" diameter gauge reads 0 to 150 psi in 2 lb increments
- Gauge also reads 0 to 1000 kpa, 0 to 10 bar, and kgf/cm pressures
- Includes a 13" flexible hose that swivels 360 degrees, a push button air relief bleeder valve, and a straight locking chuck
- The inlet fitting is 1/4" NPT male
- For use with an appropriate air device such as an air compressor or air pump

UPC	Master	Inner
8-02090-19344-6	24	6



Digital Tire Inflator **19357**

- 3" diameter rubber protected gauge with easy to read backlit LCD display
- Air bleed function
- 22" long high-pressure swivel rubber hose with locking air chuck 90 second auto-off function
- Four units of measure: PSI, Bar, kPa, and kgF
- Inflation range: 0-174 psi, 0-12 Bar, 0-1200 kPa, 0-12 kgF
- Max inlet air supply: 232 psi
- Inlet thread: 1/4" NPT female
- Requires (2) CR2450 batteries (included)
- For use with an appropriate air device such as an air compressor or air pump.

UPC	Master	Inner
8-02090-19357-6	20	1

20 in. Replacement Hose **19358**

UPC	Master	Inner
8-02090-19358-3	30	1

Air Line Inflator Gauge **19341**

- Gauge reads 20 to 120psi in 2lb increments.
- Features a 13" 300psi flexible hose, with push button air relief bleeder valve and 1/4" NPT male fitting.
- Includes a 6" 1/4" NPT female inlet dual-head chuck. Inlet fitting is a 1/4" NPT female.
- For use with an appropriate air device such as an air compressor or air pump.



17 pc. 1/4" Air Line Accessory Kit 19338

- 17 pc. kit includes:
- (1) Blow Gun
- (2) 1/4" NPT brass double male connectors
- (1) 1/4" NPT double female connector
- (1) Pencil tire pressure gauge
- (1) 1/4" NPT brass female coupler
- (2) 1/4" NPT female plugs
- (4) 1/4" NPT male plugs sports ball inflator and adapter
- (1) Inflatable toy inflator and safety adapter



UPC	Master	Inner
8-02090-19338-5	24	6

5 pc. High Flow Coupler and Plug Set 19460

- Set Includes: (1) Female Coupler, (1) Female Plug, (3) Male Plugs
- 1/4" Industrial style
- Aluminum construction
- Black anodized finish
- Working pressure: 0-300 PSI
- Max pressure: 300 PSI
- Air flow: 40-45 SCFM

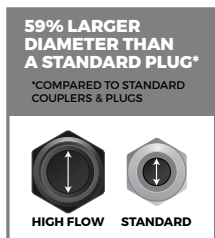

UPC	Master	Inner
8-02090-19460-3	48	6

A 2 pc. A Style Plug Sets

- Steel construction



T 2 pc. T Style Plug Sets

- Steel construction

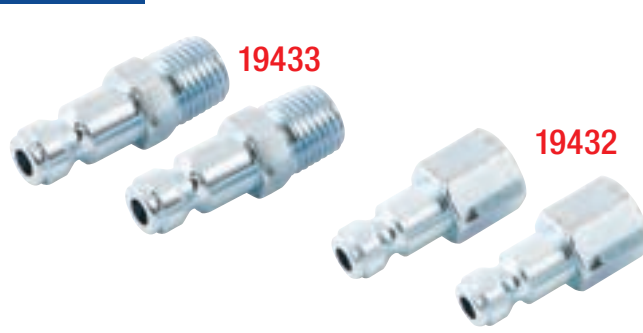
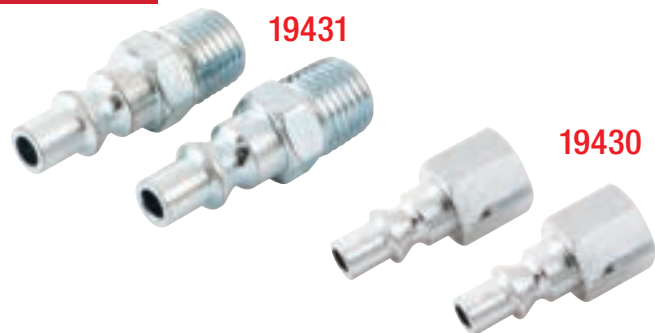

Part #	Connector Type	UPC	Master	Inner
19430	Female	8-02090-19430-6	192	12
19431	Male	8-02090-19431-3	192	12

Part #	Connector Type	UPC	Master	Inner
19432	Female	8-02090-19432-0	192	12
19433	Male	8-02090-19433-7	192	12

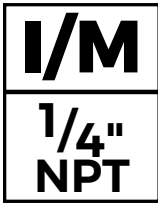

I/M Industrial Style Couplers & Plugs

- For use with I/M style plugs
- Inlet size: 1/4" NPT



19330



19333

Part #	Set Contents/Type	UPC	Master	Inner
19330 4-pc set	(1) steel female coupler, male plug, (1) female plug, (1) double male connector	8-02090-19330-9	96	12
19333 5-pc set	(1) 1-5/8" long, 1/4" NPT male plugs and (1) 2" long, 1/4" NPT female coupler	8-02090-19333-0	48	6
Plugs				
19322 2-pc set	Male	8-02090-19322-4	192	12
19325 2-pc set	Female	8-02090-19325-5	192	12
Couplers				
19326	Female	8-02090-19326-2	192	12
19343	Male	8-02090-19343-9	192	12

19322



19325



19343



19326



AMT 3-Way Composite Coupler

- Constructed from lightweight yet durable nylon material
- Max working pressure: 210 psi
- For use with A, M, and T-style fittings
- Inlet size: 1/4" NPT

Part #	Connector Type	UPC	Master	Inner
19304	Female	8-02090-19304-0	200	10
19305	Male	8-02090-19305-7	200	10



AMT 3-Way Quick-Connect Coupler 19461

- Quick-connect design allows for quick assembly and release of air tools
- AMT 3-Way Style accepts the three most popular 1/4" nipple styles: A-style: ARO 210 style, M-style: Milton or Industrial style, T-style: Tru-Flate/Parker Automotive style
- Inlet size: 1/4" NPT female
- Overall length: 2"



UPC	Master	Inner
8-02090-19461-0	192	12

Universal Coupler 19437

- Universal brass constructed female coupler
- Overall length: 2"
- Inlet fitting: 1/4" NPT female
- For use with A, M, and T-style plugs



UPC	Master	Inner
8-02090-19437-5	192	12

Female Air Chuck With Clip 19334

- Ball foot air chuck with safety/security clip
- For safe secure inflation of inflatables
- Constructed from zinc-brass materials
- Inlet is 1/4" NPT female



UPC	Master	Inner
8-02090-19334-7	192	12

Female Ball Foot Chuck 19323

- Ball foot air chuck for use with air hoses
- Constructed from zinc-brass
- Inlet is 1/4" NPT female



UPC	Master	Inner
8-02090-19323-1	192	12

Dual Head Tire Chuck 19324

- This 5-3/4" dual-head tire chuck is used for tire valves on dual wheeled vehicles such as trucks, buses, RV's, and tractors.
- Inlet is 1/4" NPT female.

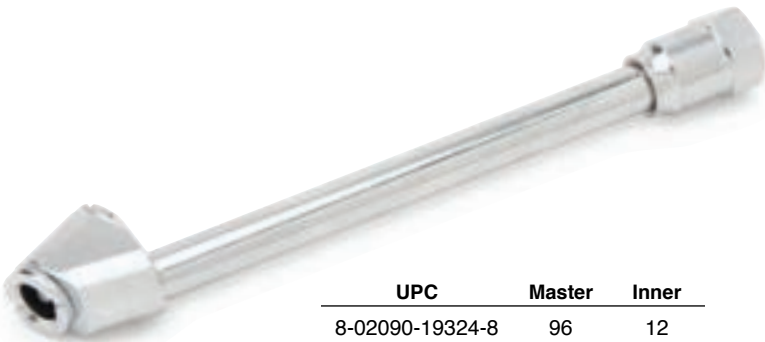

UPC	Master	Inner
8-02090-19324-8	96	12

Ball Foot Chuck 19321

- Brass ball foot air chuck
- Inlet Size: 1/4" NPT male
- Overall length: 1-1/2"



UPC	Master	Inner
8-02090-19321-7	192	12

20 pc. Air Accessory Set 19443

- Set includes:
- (1) 1/4" NPT female connector
- (2) 1/4" NPT female quick-connect plug
- (3) 1/4" NPT male quick-connect plug
- (1) Tapered barbed brass blow gun nozzle
- (1) Thread seal tape 1/2" x 260"
- (2) 1/4" NPT female universal quick-connect coupler
- (1) Blow gun safety nozzle
- (1) Blow gun adapter
- (1) Blow gun rubber nozzle
- (1) 1/4" NPT male connector
- (1) 6" dual-head tire chuck
- (1) 5-1/2" pencil tire gauge
- (1) 1/4" x 25 ft. polyethylene recoil air hose
- (1) 3-1/2" blow gun



UPC	Master	Inner
8-02090-19443-6	24	6

Needle and Nozzle Sets



Part #	Size (mm)	UPC	Master	Inner
19000-17	1.7	N/A	20	1
19000-20	2	N/A	20	1
19000-23	2.3	N/A	20	1
19100-23	2.3	N/A	20	1

Thread Seal Tape

- For use on pipe and fitting connections to help prevent air leaks
- Made from PTFE material
- 1/2" x 260" roll



Part #	UPC	Master	Inner
19320 CARDED	8-02090-19320-0	288	24
19329 10-pc Bulk	8-02090-19329-3	24	6



11 pc. Spray Gun Cleaning Kit 19112

- Ideal for cleaning all types of paint spray guns
- Maintain your spray guns and keep them lasting longer
- Brushes can be used with all spray gun cleaning solvents
- Designed to clean gun and all fluid and air passages without damage

UPC	Master	Inner
8-02090-19112-1	48	6

600ml Plastic Cup and Lid 19900

- Genuine VAPER® Replacement Part
- Fits VAPER 19000 Series gravity feed spray guns
- 600ml Capacity
- Includes vented screw-on lid



UPC	Master	Inner
8-02090-19900-4	24	6

2 pc. Plastic Lid for 150 ml. Paint Cup 19902

- Genuine VAPER® Replacement Part
- Fits VAPER 19100 & 19200 Series Gravity feed touch-up spray guns
- Snug fitting press fit
- For 150ml capacity stainless steel paint cups



UPC	Master	Inner
8-02090-19902-8	48	6

150 ml. Stainless Steel Paint Cup 19903

- Genuine VAPER® Replacement Part
- Fits VAPER 19100 & 19200 Series gravity feed touch-up spray guns
- 150ml Capacity
- Includes snug fitting press fit lid



UPC	Master	Inner
8-02090-19903-5	72	6

1000 ml. Paint Cup Replacement Lid 19907

- Genuine VAPER® Replacement Part
- Fits VAPER 19100 & 19200 Series gravity feed production spray guns
- Snug fitting press fit
- For 1000ml capacity aluminum paint cups



UPC	Master	Inner
8-02090-19907-3	24	6

1000 ml. Aluminum Paint Cup and Lid 19906

- Genuine VAPER® Replacement Part
- Fits VAPER 19100 & 19200 Series gravity feed production spray guns
- 1000ml Capacity
- Includes snug fitting press fit lid



UPC	Master	Inner
8-02090-19906-6	24	6

2 pc. Disposable Inline Moisture Filters 19302

- Helps reduce painting defects
- Removes moisture, oil vapor and rust particles that pass through conventional filters
- Mounts at spray gun for best protection
- High flow design minimizes pressure drop to spray gun



UPC	Master	Inner
8-02090-19302-6	48	6

Air Spray Gun Holder 19990



- Heavy duty steel construction
- Funnel holder over paint cup for easy filling

UPC	Master	Inner
8-02090-19990-5	10	5

5 pc. In-Line Paint Filter 19911

- Genuine VAPER® Replacement Part
- Fits all VAPER® Gravity feed spray guns
- In-line mesh filter removes dirt particles from paint to protect against defects
- Insert into gravity feed spray gun fluid inlet prior to cup installation



UPC	Master	Inner
8-02090-19911-0	144	12

Locking Air Regulator and Gauge 19303

- 1/4" Locking Pressure Regulator with Gauge
- Small & lightweight
- Attaches to all conventional and HVLP spray guns
- Easy to read 1-1/2" diameter gauge



UPC	Master	Inner
8-02090-19303-3	48	6

Magnetic Spray Gun Holder 19991

- Provides convenient storage of gravity feed spray guns when not in use
- Attaches to spray booth walls, work stations, tool boxes, or any metal surface
- Vinyl-coated hooks protect spray gun finish from scratches



UPC	Master	Inner
8-02090-19991-2	24	6

Spray Gun Rebuild Kit for 19800 19015



UPC	Master	Inner
8-02090-19015-5	50	1

Spray Gun Rebuild Kit for 19000 Series 19908

- Genuine VAPER® Replacement Part
- Fits VAPER 19000 Series gravity feed production spray guns
- Extend the life of your spray gun



UPC	Master	Inner
8-02090-19908-0	144	12

Spray Gun Rebuild Kit for 19100 Series 19909

- Genuine VAPER® Replacement Part
- Fits VAPER 19100 & 19200 Series gravity feed production spray guns
- Extend the life of your spray gun
- Includes all parts needed for a rebuild



UPC	Master	Inner
8-02090-19909-7	144	12

Spray Gun Rebuild Kit for Touch Up Gun 19910

- Genuine VAPER® Replacement Part
- Fits VAPER 19100 & 19200 Series gravity feed touch-up spray guns
- Extend the life of your spray gun
- Includes all parts needed for a rebuild



UPC	Master	Inner
8-02090-19910-3	144	12

4 pc. Air Chisel Set 19355

- Assortment of the 4 most popular chisels for Vaper 19709 air hammer and other similar models with .401" bores
- 4-3/4" overall length
- Busing, splitter, weld buster, ripping chisel and tapered punch



UPC	Master	Inner
8-02090-19355-2	36	6

5 pc. 3 in. x 1/16 in. Cut-Off Wheels 19336

- 3" diameter x 1/16" thick
- Fits standard 3/8" spindle
- 25,000 RPM rating
- For use with Vaper #19703 cut-off tool and other similar models



UPC	Master	Inner
8-02090-19336-1	192	12

Sandblaster Ceramic Tip 19451

- Replacement part for #19450 Portable Sand Blaster
- Tip Opening (Tapered Side): 3/16"



UPC	Master	Inner
8-02090-19451-1	250	25

2 pc. Air Hammer Retainer Springs 19710

- Replacement spring for 19709
- Spring outside diameter: 3.4cm
- Spring material Diameter: 0.3cm
- 8 wonds
- Center distance of two hooks: 3.8cm
- Total length: 4.9cm



UPC	Master	Inner
8-02090-19710-9	40	1

5 pc. Grinding Stone Assortment 19352

- 5 Assorted grinding stones for Vaper 19701 die grinders and similar models with 1/4" collets
- Rated for 25,000 RPM



UPC	Master	Inner
8-02090-19352-1	72	12

6 in. Sanding Pad 19226

- Standard replacement pad for Vaper item 19225 and other dual action sanders
- For self-adhesive abrasives
- Max operating speed: 10,000 RPM



UPC	Master	Inner
8-02090-19226-5	10	1

SOLAR POWERED

DIN 9 to DIN 13

Complies with DIN, ISO, EN379 and ANSI Z87.1-2003

AUTO-DARKENING WELDING HELMETS

- Ultra high performance filters protect against UV & IR
- Automatically changes from a light to a dark state when arc is struck
- Durable, lightweight material is corrosion resistant and flame retardant
- Outside sensitivity adjustment provides clear vision prior to and during welding
- Turnover headband mechanism allows for greater comfort and reduces fatigue
- Utilizes high performance solar cells w/ 2 built-in 3V lithium batteries as power back-up

45000

- Grind mode Capable



CE CLASSIFICATION **1/2/1/1**

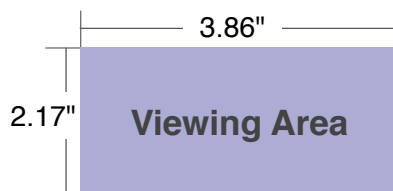

ARC SENSORS 4

45001

- 3.85" x 1.70" viewing area



Part #	Description	UPC	Master	Inner
45000	Black	8-02090-45000-6	4	1
45001	Replacement Lens	8-02090-45001-3	400	40

41254 BLACK

41260 RED

CE CLASSIFICATION **1/2/1/1**



ARC SENSORS 2

- Hard hat adaptable
- Grind mode Capable

41261 Replacement Lens

- 3.85" x 1.70" viewing area



Part #	Description	UPC	Master	Inner
41254	Black	8-02090-41254-7	4	1
41260	Red	8-02090-41260-8	4	1
41261	Replacement Lens	8-02090-41261-5	400	40

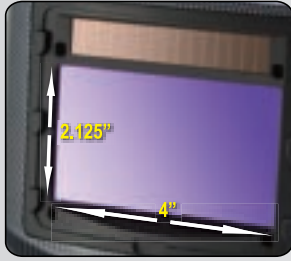

CE CLASSIFICATION 1/2/1/1

- Hard hat adaptable
- Grind mode Capable
- Solar Powered

ARC
SENSORS **4**



41262



41265



41266



41267



41279



41282



41283



41288



41289



41290



41263



41924



41264

Part #	Description	UPC	Master	Inner
41262	Black	8-02090-41262-2	4	1
41265	Eagle/Stars	8-02090-41265-3	4	1
41266	Skull/Flames	8-02090-41266-0	4	1
41267	Razer/Red	8-02090-41267-7	4	1
41279	Skull/Green	8-02090-41279-0	4	1

Part #	Description	UPC	Master	Inner
41282	Skull/Pistol	8-02090-41282-0	4	1
41283	Skull/Wrench	8-02090-41283-7	4	1
41288	Pin Up Girl	8-02090-41288-2	4	1
41289	Skull	8-02090-41289-9	4	1
41290	Gear Head	8-02090-41290-5	4	1

Part #	Description	UPC	Master	Inner
41264	Replacement Lens	8-02090-41264-6	400	40
41263	Replacement Headgear	8-02090-41263-9	36	1
41924	2x Magnifying Lens	8-02090-41924-9	60	10

Welding Helmets

Fixed Shade Welding Helmet 41247

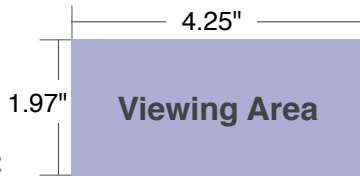

**DIN SHADE
12**

- Durable, light weight material is corrosion resistant and flame retardant
- 4.25" x 1.97" viewing area
- Clear vision both prior and during welding offers improved quality and higher work efficiency
- Protection against UV (ultraviolet) and IR (infrared) radiation



UPC	Master	Inner
8-02090-41247-9	4	1

90-amp Gasless Wire Feed Welder 41185

- Easy-to-use gasless flux-core wire welder for the beginner
- Perfect for light duty repairs, maintenance and fabrication on light gauge steel around home, workshop and garage
- Welds up to 1/8" thick mild steel - not suitable for aluminum
- Operates on 120V single phase power
- Uses 0.030" to 0.035" diameter flux-core wire
- Thermal overload protector automatically shuts off welder when duty cycle is exceeded.
- Fan cooled for better performance



UPC	Master	Inner
8-02090-41185-4	1	1

180-Amp Dual System Mig-Arc Welder 41198

- Lightweight and portable _ just 28 pounds!
- Powerful and reliable IGBT inverter technology delivers 180 Amps at a 30% duty cycle
- Dual voltage-sensing technology (115V or 230V) lets you plug into any common power supply with included adapter cord
- Versatile dual process system handles MIG, Flux Core and DC Stick welding applications in one package
- Flux-Cored (no gas): Tackles the biggest jobs
- MIG (requires shielding gas): Weld up to 5/16 in. mild or stainless steel
- DC Stick: Handles up to 5/32 in. stick electrodes

UPC	Master	Inner
8-02090-41198-4	1	1



30-Amp Plasma Cutter 41199

- Lightweight and portable _ less than 21 pounds!
- Powerful and reliable IGBT inverter technology delivers 30 Amps at a 35% duty cycle
- Dual voltage-sensing technology (115V or 230V) lets you plug into any common power supply with included adapter
- Cuts mild steel, stainless, brass, aluminum and other conductive materials
- Low frequency, pilot arc system for instant starts and ease of use when cutting rusty material and will not interfere with other electrical systems including telephone or computer
- Self-resetting thermal overload protection with indicator light automatically shuts off to avoid overheating
- Adjustable air filter/pressure regulator

UPC	Master	Inner
8-02090-41199-1	1	1



Welding Cart 41197

- Designed to store and transport: most MIG and plasma machines, shielding gas tanks and other welding equipment and accessories
- Front mounted handle for easy maneuverability
- Includes (2) Safety chains to secure shielding gas tanks
- Front wheel swivel casters
- Heavy duty molded rear wheels
- Tilted top shelf allows easy access to welder controls
- Side hooks for torch & cable storage
- Additional shelves for storing welding helmets, equipment & accessories
- Durable steel construction
- Top Shelf Dimensions: 11 Inch Wide x 17.50 Inch Long
- Overall cart dimensions: 32 in. High x 27.64 in. Long x 17 in. Wide

UPC	Master	Inner
8-02090-41197-7	1	1



Welding Gloves 41239

- Premium Leather
- Lined



UPC	Master	Inner
8-02090-41239-4	60	12

Brazing and Cutting Goggles 41235

- Shade #5 lens protects eyes from harmful rays during oxy-acetylene brazing, cutting, and welding.
- Soft vinyl frame for comfort
- Meets ANSI Z87.1 and OSHA standards



UPC	Master	Inner
8-02090-41235-6	120	12

Chipping Hammer 41225

- Use to chip and remove slag from welds
- Coiled spring handle helps absorb shock while chipping



UPC	Master	Inner
8-02090-41225-7	48	6

MIG Wire Utility Pliers 11448

- Needle nose pliers and wire cutter for pulling and trimming MIG wire
- Sharp edges for cleaning inside nozzle and around tips
- Small serrated hole for MIG tips
- Large serrated hole for nozzles

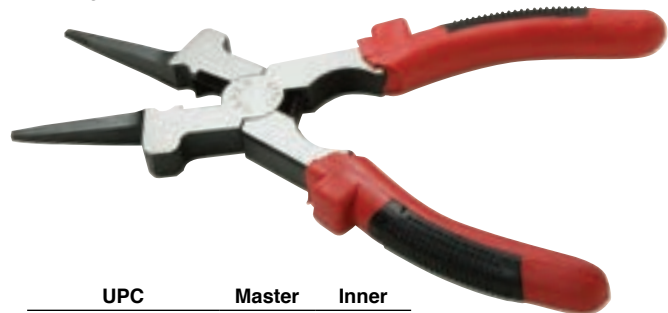

UPC	Master	Inner
8-02090-11448-9	36	6

Soap Stone Holder 41222

- Pen type holder includes collet-style clamp with pocket clip and built-in sharpener
- Includes one round soapstone marker
- White lines are visible through shaded welding lens
- Use to mark and outline weld areas on steel and other alloys



UPC	Master	Inner
8-02090-41222-6	240	24

Round Soap Stones 41221

- Use to mark and outline weld areas on steel and other alloys
- White lines are visible through shaded welding lens
- six soapstones



UPC	Master	Inner
8-02090-41221-9	240	24

Welding Tip Cleaner 41223



- Use to clean spatter and debris from oxy-fuel and welding tips
- Includes 13 tip cleaners and one file clip

UPC	Master	Inner
8-02090-41223-3	240	24

4 in. Magnetic Ground Block 41196

- Ground any arc welder
- Powerful magnetic base



UPC	Master	Inner
8-02090-41196-0	24	6

Magnetic Support Jigs

- Ideal for holding objects while tack-welding, soldering, and pipe installing
- Strong magnet holds iron materials at 45, 90 and 135 degree angles

41291

- Holds up to 25 lbs.



41292

- Holds up to 40 lbs.



41294

- Holds up to 75 lbs.



Part #	Description	UPC	Master	Inner
41291	Small	8-02090-41291-2	60	10
41292	Medium	8-02090-41292-9	24	6
41294	Large	8-02090-41294-3	20	5

8 in. Flat Jaw Welding Pliers 41192

- 3 3/8" Jaw width
- Takes the hassle out of bending or folding sheet metal
- Cast iron construction
- Rubber dipped cushion grips



UPC	Master	Inner
8-02090-41192-2	36	6

Small Brass Wire Brush 41226

- Brass bristles ideal for cleaning aluminum welds
- Small size fits into tight corners
- Angled handle helps protect knuckles
- 7/8" x 7" overall length



Part #	Size	UPC	Master	Inner
41226	Brass	8-02090-41226-4	360	36
41227	Stainless Steel	8-02090-41227-1	360	36

Stainless Steel Shoe Horn Wire Brush 41228

- Ideal for removing debris and cleaning weld
- 1" x 2" x 10" Overall Length



UPC	Master	Inner
8-02090-41228-8	48	6

Stainless Steel Wire Brush 41229

- Ideal for removing debris and cleaning welds
- 1-7/8" x 1" x 13-3/4" overall length



UPC	Master	Inner
8-02090-41229-5	120	12

20 pc. Mig Welder Contact Tip Assortment 41191

- Set Includes:
 - 5pc .023" tips
 - 5pc .030" tips
 - 5pc .035" tips
 - 5pc .045" tips
- Precision copper replacement tips for most mig welders



UPC	Master	Inner
8-02090-41191-5	48	12

4 pc. Contact Tip Sets



Part #	Size	UPC	Master	Inner
41249	.024"	8-02090-41249-3	480	40
41250	.030"	8-02090-41250-9	480	40
41251	.035"	8-02090-41251-6	480	40

2 pc. Mig Torch Gas Nozzles 41195

- 2pc kit
- Length: 2 1/8"
- Diameter: 11/16"



UPC	Master	Inner
8-02090-41195-3	144	12

Welding Nozzle 41252

- Wire feed replacement nozzle



UPC	Master	Inner
8-02090-41252-3	144	12

Welding Rods

- Works with all brands of 115V welders
- Smooth bead with low spatter and fast deposition



Part #	Description	Usage	Weight	Size	UPC	Master	Inner
41230	Fast Fill Welding Rods	18-ga to 1/8" mild steel	.5 lbs	1/16 in.	8-02090-41230-1	48	12
41231	General Purpose Welding Rods	18-ga to 1/8" mild steel	.5 lbs	5/64 in.	8-02090-41231-8	48	12
41232	General Purpose Welding Rods	18-ga to 1/8" mild steel	.5 lbs	1/16 in.	8-02090-41232-5	48	12
41234	Deep Penetrating Welding Rods	18-ga to 3/8" mild steel	.5 lbs	1/8 in.	8-02090-41234-9	48	12
41236	Deep Penetrating Welding Rods	18-ga to 3/8" mild steel	5 lbs	1/8 in.	8-02090-41236-3	10	1
41237	General Purpose Welding Rods	18-ga to 3/8" mild steel	5 lbs	1/8 in.	8-02090-41237-0	10	1
41238	Deep Penetrating Welding Rods	18-ga to 3/8" mild steel	5 lbs	3/32 in.	8-02090-41238-7	10	1
41233	Brass Brazing Rods	steel, copper alloys, cast iron nickel alloys and stainless steel	-	3/32 in.	8-02090-41233-2	48	12

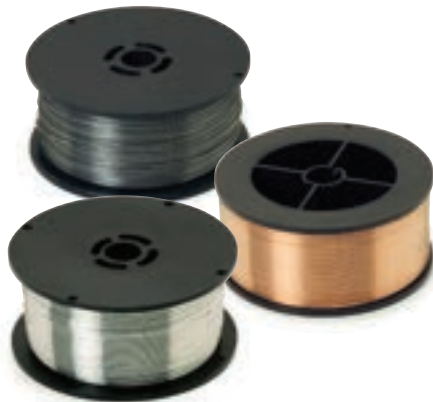

Welding Wire

Part #	Description	Material	Size	UPC	Master	Inner
41242	Flux Core	E71T-GS alloy	.030"	8-02090-41242-4	20	1
41245	Flux Core	E71T-GS alloy	.035"	8-02090-41245-5	20	1
41240	Mig	6 Alloy	.030"	8-02090-41240-0	20	1
41241	Mig	6 Alloy	.035"	8-02090-41241-7	20	1
41244	Aluminum Wire		.030"	8-02090-41244-8	20	1

Oxygen/Acetylene Welding Tips

- Brass spiral mixer for free-flowing flame
- Copper gas tube with angled tip
- Female threaded copper coupling hex bolster
- Ideal replacement tip for use with out heavy-duty welding kit

Part #	Size	UPC	Master	Inner
41193	#2	8-02090-41193-9	60	30
41194	#6	8-02090-41194-6	60	30

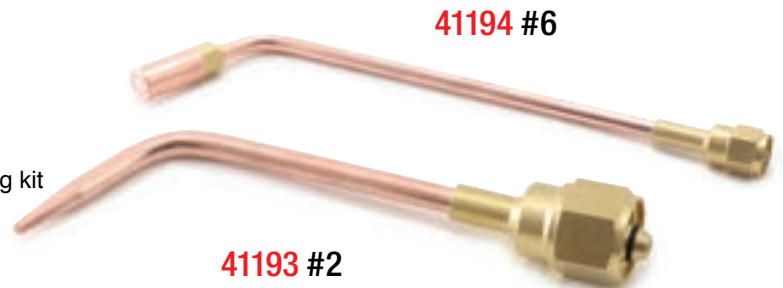

Blind Hole Bearing Puller 51362

- For use with a wide range of applications which require an internal pull such as pilot bearing and needle bearing removal
- 5 pc. set includes: (1) 3-1/2 lb. T-handle slide hammer; (4) Expanding collets, sizes: 3/8 in. to 1/2 in., 9/16 in. to 11/16 in., 5/8 in. to 1 in. and 1 in. to 1-1/4 in.
- Includes storage case



UPC	Master	Inner
8-02090-51362-6	4	1



Slide Hammer Puller Set 51310

- 5 lb hammer
- 9 applications: Front hub puller, rear axle puller, external 3-jaw pull, internal 3-jaw puller, internal 2-jaw puller, external 2-jaw puller, puller hook, dent puller ,grip wrench

UPC	Master	Inne
8-02090-51310-7	2	1

1-Liter Vacuum Brake Fluid Bleeder 51885

- 3/8" NPT
- Maximum capacity: 1 liter (33 oz): Working pressure: 71-113 PSI: Maximum pressure: 113 PSI
- Uses standard workshop air supply
- Universal rubber fitting holds securely on brake bleed screw
- Transparent drain hose allows visual inspection of old fluid during bleeding

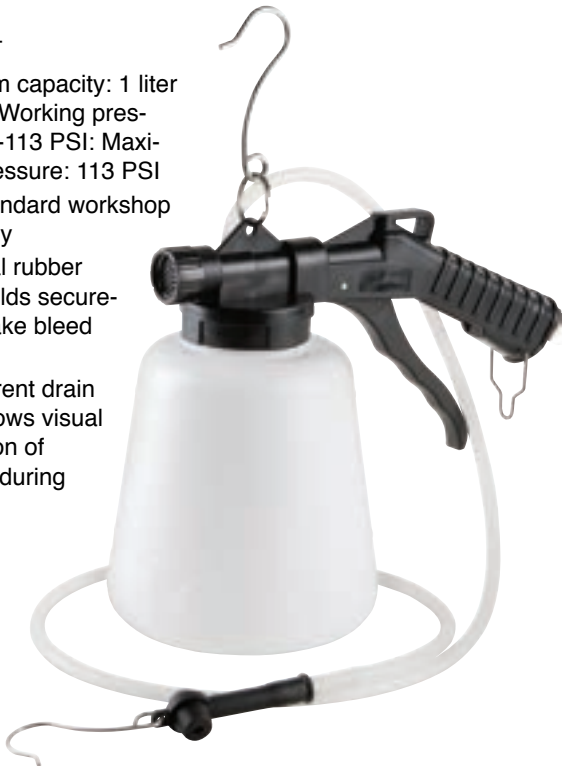

UPC	Master	Inner
8-02090-51885-0	20	1

Brake Caliper Hanger Set 51600

- 1/4 in. Heavy-duty steel
- Hi-visibility powder coated finish
- Hold exhaust systems during installation, painting small parts, or holding items under the hood or car
- Perfect for a variety of automotive work: brakes, wheel bearings, axle shafts & suspension



UPC	Master	Inner
8-02090-51600-9	80	20

5 pc. 1/2 in. Drive 12pt Axle Nut Socket Set 15345

- For removal and installation of axle nut and automatic transmission tail output shafts

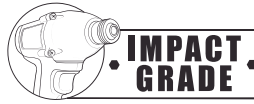

UPC	Master	Inner
8-02090-15345-7	5	1

SET COMPONENTS				
Part#	Size (mm)	UPC	Master	Inner
15230	30	8-02090-15230-6	5	1
15232	32	8-02090-15232-0	24	6
15234	34	8-02090-15234-4	24	6
15236	36	8-02090-15236-8	24	6
15239	39	8-02090-15239-9	24	6



1/2 in. Drive 6pt Axle Nut Sockets



Part#	Size (mm)	UPC	Master	Inner
15328	28	8-02090-15328-0	24	6
15329	29	8-02090-15329-7	24	6
15330	30	8-02090-15330-3	24	6
15331	31	8-02090-15331-0	24	6
15332	32	8-02090-15332-7	24	6
15333	33	8-02090-15333-4	24	6
15334	34	8-02090-15334-1	24	6
15335	35	8-02090-15335-8	24	6
15336	36	8-02090-15336-5	24	6
15338	38	8-02090-15338-9	24	6

1/2 in. Drive 1-11/16 in. Dodge Spindle 51830

- 1-11/16 in. opening
- Chrome moly construction



UPC	Master	Inner
8-02090-51830-0	24	6

Ball Joint Separator 51802

- Fork Width: 15/16 in.
- Fork Depth: 2-15/16 in.
- Overall Length: 11-3/4 in.
- Knurled handles for better grip



UPC	Master	Inner
8-02090-51802-7	20	5

Tie Rod Separator 51801

- Fork Width: 11/16 in.
- Fork Depth: 3-1/4 in.
- Overall Length: 16 in.
- Knurled handles for better grip



UPC	Master	Inner
8-02090-51801-0	20	5

Flexible Hose Clamp Driver 12229

- Set Includes: (1) 1/4" drive x 11" flexible driver
(2) 1/4" drive 6-point sockets: 1/4 in. & 5/16 in.
- Works with mini & standard hose clamps
- Use in hard to reach areas such as confined engine spaces & plumbing applications
- Flexible driver provides up to 90-degree access



UPC	Master	Inner
8-02090-12229-3	72	12

Honda/Acura Crankshaft Pulley Holder 51700

- For use on most Honda & Acura applications 1992 & later
- Allows for stationary positioning of the crankshaft when servicing the engine and powertrain



UPC	Master	Inner
8-02090-51700-6	36	6

AC Fin Comb 51500

- Cleans and straightens condenser and evaporator fins
- 6-sided head for 8, 9, 10, 12, 14 and 15 fins-per-inch applications

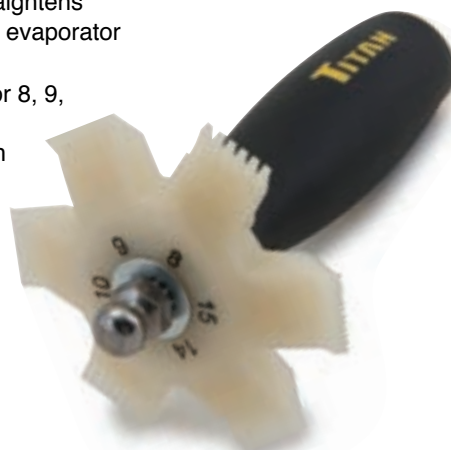

UPC	Master	Inner
8-02090-51500-2	48	6

Oxygen Sensor Socket 51704

- For removing and installing oxygen sensors and vacuum switches in most foreign and domestic vehicles (7/8 in. & 22mm)
- Can be used with 3/8 in. drive ratchet or 7/8 in. wrench
- 2-1/2 in. deep socket easily removes long sensors
- Cut-away side allows for sensor wire clearance



UPC	Master	Inner
8-02090-51704-4	48	12

Offset Oxygen Sensor Wrench 51739

- For removing and installing oxygen sensors and vacuum switches in most foreign and domestic vehicles (7/8 in. & 22mm)
- Offset design provides extra leverage for easier removal in tight hard to reach areas
- 3/8 in. square drive
- Cut-away side allows for sensor wire clearance



UPC	Master	Inner
8-02090-51739-6	48	12

7 pc. Double Flaring Tool Set 51425

- For use with 5 different sizes of copper, aluminum, soft steel and brass tubing
- Adapter sizes include: 3/16, 1/4, 5/16, 3/8 & 1/2 inch

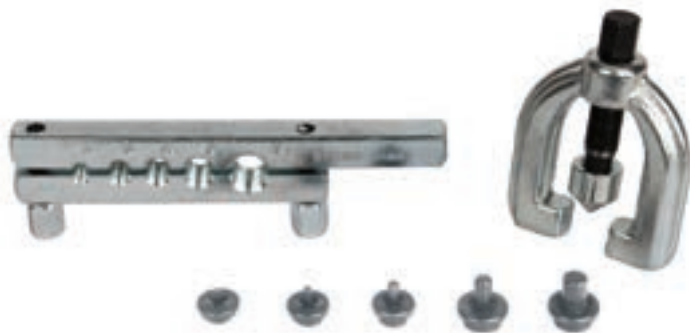

UPC	Master	Inner
8-02090-51425-8	12	6

3/16 in. Double Flaring Tool 51535

- For use with creating a double flare on 3/16 inch steel, nickel & copper tubing
- Comes with flaring tool, double ended OP1/OP2 punch, die lubricant & positioning bolt



UPC	Master	Inner
8-02090-51535-4	24	6

4-in-1 Quick-Change Tube Bender Pliers 51502

- Bends 3/16, 1/4, 5/16, & 3/8" outside diameter of brass, copper, steel or aluminum tubing
- Satin Chrome Finish



UPC	Master	Inner
8-02090-51502-6	24	6

Mini Tubing Bender 51503

- Bends 1/8, 3/16, & 1/4" outside diameter of brass, copper, steel or aluminum tubing
- Compact for close quarters applications
- Bends 90 degrees accurately



UPC	Master	Inner
8-02090-51503-3	144	12

Fuel Line Disconnect Tool 51614

- For fast and easy separation of quick disconnect style fittings
- For use on both 5/16" & 3/8" fuel lines with quick disconnect fittings
- Necessary for fuel filter replacement & service on many late model vehicles
- For use on many applications including: Ford: 1990 thru current. Mazda: 1990 thru current

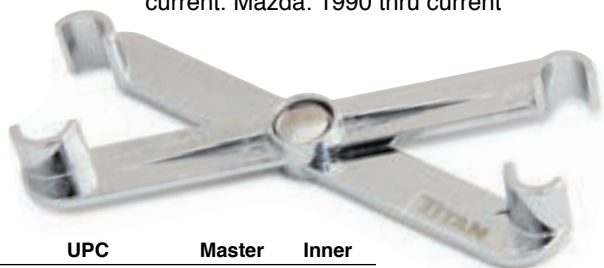

UPC	Master	Inner
8-02090-51614-6	72	6

Fuel and Air Conditioning Line Disconnect Tool 51613

- For fast and easy separation of quick disconnect style fittings
- For use on 3/8", 1/2", 5/8", 3/4" lines with quick disconnect fittings
- Necessary for fuel, heater, and A/C line service on many late model vehicles

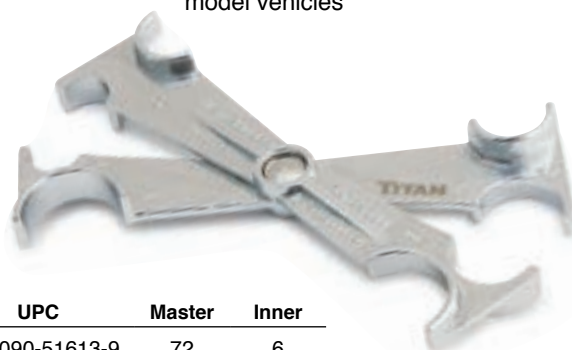

UPC	Master	Inner
8-02090-51613-9	72	6

Door Upholstery Remover 51507

- 5/16" square tip design for removal of plastic fasteners from door panels
- Removes door panel fasteners
- Unique, square cutout in the tool tip provides a no-slip grip, even on fasteners with small ears
- Ergonomic soft grip handle for maximum comfort

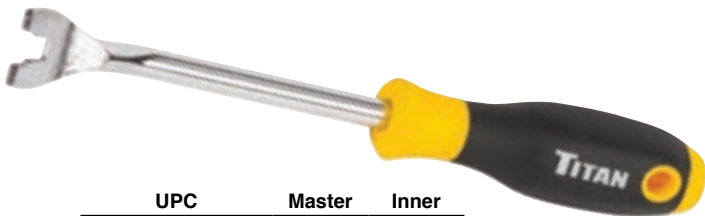

UPC	Master	Inner
8-02090-51507-1	72	6

Door Spring Tool 15040

- Designed to quickly and easily remove or install car door hinge springs
- Services GM cars and GM light duty trucks
- Can be used with a 1/2" open end or ratcheting box wrench



UPC	Master	Inner
8-02090-15040-1	36	6

Precision Oiler 15200

- For precision oiling in tight and hard-to-reach places and machines
- Smooth actuator allows for greater control and placement of lubricant
- Aluminum construction
- Protective screw-on cover prevents leakage
- Convenient pocket clip
- Overall length is 5-5/8" (143mm)



UPC	Master	Inner
8-02090-15200-9	96	12

Automotive Fluid Syringe 51884

- For use with all types of automotive fluid
- Transparent design allows viewing volume and fluid condition
- Detachable tube with cap disassembles for easy cleaning
- Corrosion resistant seals withstand a broad variety of fluid types
- Units of measure: QT / CC
- Maximum capacity: .21 QT/ 200 CC

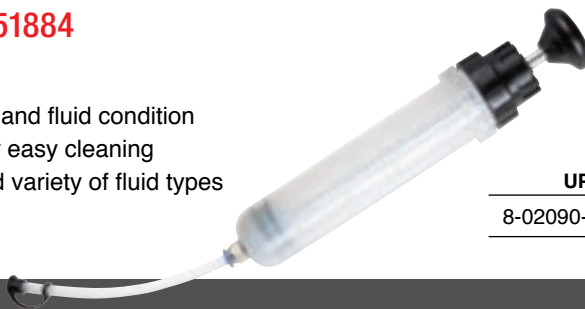

UPC	Master	Inner
8-02090-51884-3	50	1

Door Panel Removal Tool 15041

- Removes door panel fasteners
- Bent handle design allows use where space is limited, and provides extra prying force
- Unique, square cutout in the tool tip provides a no-slip grip, even on fasteners with small ears
- Ergonomic soft grip handle for maximum comfort

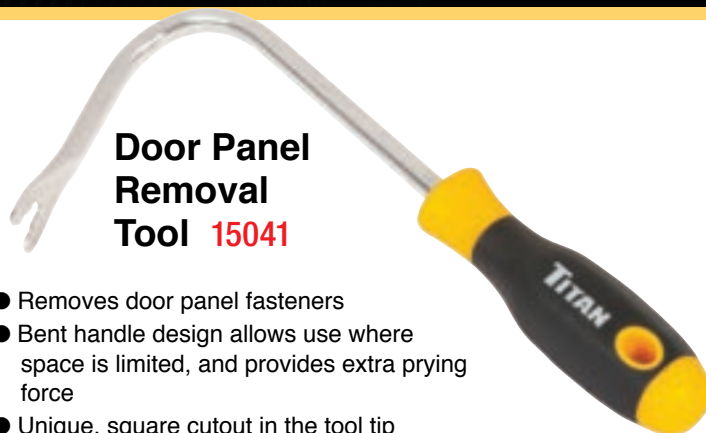

UPC	Master	Inner
8-02090-15041-8	48	6

High Temp Infrared Thermometer 51408

- Temp Range: -58° F to 1202° F (-50° C to 650° C)
- Built-in laser pointer
- Automatic Selection 0.1°C/1°F
- °C/°F switchable button
- Emissivity 0.95(fixed).
- Automatic Data Hold & Auto power off
- D:S ratio:8:1
- Backlit LCD display
- Max and Min function



UPC	Master	Inner
8-02090-51408-1	72	12

36 in. x 25 in. Galvanized Drip Pan 22037

- Great work surface for messy jobs
- Keeps excess waste off of garage/shop floor or driveway
- Overall dimensions: 36" x 25"
- Made of galvanized metal
- Very durable



UPC	Master	Inner
8-02090-22037-1	12	1

7 Quart Drain Pan 22036

- Unique oversize pouring spout
- 7 quart capacity
- Heavy wall construction retains shape during use
- Built-in raised rim handles for ease of use



UPC	Master	Inner
8-02090-22036-4	24	12

18 in. Multi-Purpose Funnel 22035

- Overall Length: 18"



UPC	Master	Inner
8-02090-22035-7	48	12

11 in. Multi-Purpose Funnel 22034

- No-mess splash guard
- Fits all sizes of filler tubes
- Extended filler neck opens gas tank trap door



UPC	Master	Inner
8-02090-22034-0	48	12

1 Pint Multi-Purpose Funnel 22033

- 1 Pint
- Made of tough high-density resin



UPC	Master	Inner
8-02090-22033-3	72	12

Pencil Style Tire Pressure Gauge

50009

- 10 to 120 PSI
- Calibrated in PSI and kPa
- Accuracy +/-2 PSI in 45PSI
- Aluminum anodized body with zinc alloy head



UPC	Master	Inner
8-02090-50009-1	400	10

Pocket Tire Gauge **50013**

- 10-60 PSI
- Angled head
- Handy pocket clip
- Comes in 25pc counter display



UPC	Master	Inner
8-02090-50013-8	300	25

Inline Blow Gun **19378**

- 1/4" NPT female inline blow gun with rubber tip and push button air actuator
- Overall body length: 1-1/2"



UPC	Master	Inner
8-02090-19378-1	48	8

Coated Ceramic Magnetic Block **11199**

- Dimensions: 7/8" wide x 1-7/8" wide x 3/8" deep
- Designed for lifting holding, retrieving and separating metal objects



UPC	Master	Inner
8-02090-11199-0	288	48

60-Lumen LED Mini Flashlight 36016

- 1 Watt Bulb
- Durable aluminum housing with wa resistant seals
- Push button to turn on/off
- Operates on 1 AA battery (included)

UPC	Master	Inner
8-02090-36016-9	144	12



Pocket Flashlight 36006

- 1 Watt LED bulb
- Generates 90 Lumens of light
- Includes 2 AAA batteries
- Aluminum construction
- Diameter: 5/8"
- Overall length: 5.5"
- Beam distance: 200ft

UPC	Master	Inner
8-02090-36006-0	144	9



7-1/2 in. Compound Diagonal Cutters 11412

- Compound lever-action handles give you more power for cutting and gripping
- Double dipped cushion grip handles for comfort
- Spring loaded handles reduce hand fatigue
- Heat-treated high carbon steel
- Ships bulk in 12pc counter display

UPC	Master	Inner
8-02090-11412-0	48	12



8 in. Stubby Adjustable Wrench 11060

- Features 1" jaw capacity with laser etched scales, both fractional and metric, on opposite sides of the head
- Head size is equivalent to a standard 8" long adjustable wrench
- Overall length is 6"
- Contoured cushion grip handle allows for user comfort

UPC	Master	Inner
8-02090-11060-3	48	6



6-in-1 Screwdriver 11010

- Chrome vanadium bits with magnetic tips
- Ergonomic soft grip handle for maximum comfort
- Contains: (4) screwdriver tips: #1 & #2 Phillip and 1/4" & 3/16" Slotted; (2) Nutdrivers: 1/4" & 5/16"

UPC	Master	Inner
8-02090-11010-8	48	6



High-Torque Ratcheting Screwdriver 11014

- 3 way ratcheting action: forward, reverse and lock
- Includes 7 screwdriver bits and bit storage
- sizes:
- 2 Phillips #1, #2
- 2 Slotted 3/16, 1/4
- 1 Square S1, S2
- 2 Star T15, T20

UPC	Master	Inner
8-02090-11014-6	48	12



Fits-All-Phillips Screwdriver 11009

- Patented, precision ground tip design fits a variety of screw sizes
- Chrome plated S2 Alloy steel shaft has fits-all-phillips on one end and 1/4" slotted at other end
- Ergonomic TPR comfort handle for maximum grip and user comfort
- Interactive counter display features assorted screws to demonstrate fits-all tip

UPC	Master	Inner
8-02090-11009-2	80	10

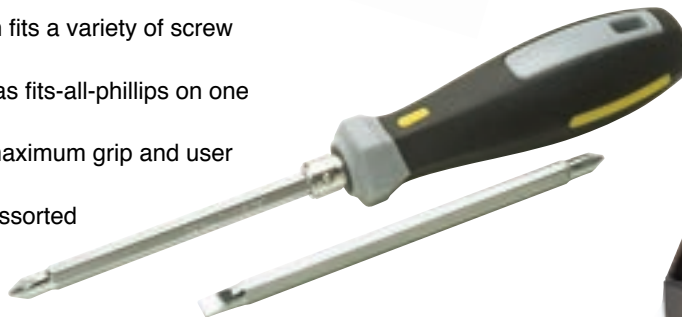

Telescoping Magnetic Pickup Tool

- Powerful magnet features shielded sides for targeted pickups
- Comfortable textured cushion grip ideal for retrieving dropped parts, fasteners and tools
- Ships in 20pc counter display



Part #	Capacity	Length	UPC	Master	Inner
11763	3 lb	5-1/2"-21-7/8"	8-02090-11763-3	120	20
11663	5 lb	6-1/2"-33"	8-02090-11663-6	120	20
11716	16 lb	7-3/4" to 30-3/4"	8-02090-11716-9	120	20



2.2x Magnifying Glass with LED Light 15029

- 2.2x magnification
- LED light
- Non-distorting optical grade glass lens
- Comfortable TPR rubber grip handle
- TPR rubber framing for extra protection
- Slide on/off switch to control light
- Lens measures 2-7/8"
- 7-1/4" overall length

UPC	Master	Inner
8-02090-15029-6	72	9



2.2x Magnifying Glass 15038

- 2.2x magnification
- Non-distorting optical grade glass lens
- Comfortable TPR rubber grip handle
- TPR rubber framing for extra protection
- Lens measures 2-7/8"
- 7-1/4" overall length
- Ships bulk in 9pc counter display

UPC	Master	Inner
8-02090-15038-8	72	9



Mini Magnetic Parts Trays

- Stainless steel dish
- Perfect for holding small parts, hardware and fasteners in place
- Sticks to any ferrous metal surface - it even works upside down!
- Rubber covered magnetic base prevents scratching



Part #	Size	UPC	Master	Inner
11061	4-1/4"	8-02090-11061-0	100	10
21264	5-7/8" diameter	8-02090-21264-2	48	6

Telescoping Inspection Mirror 11160

- Extends to 18-1/2"
- 1-1/8" Diameter Mirror
- Handy Pocket Clip



UPC	Master	Inner
8-02090-11160-0	300	25

3 lb. Telescoping Magnetic Pickup Tool 11161

- Extends to 25"
- Handy Pocket Clip
- Comes in 25pc Counter Display



UPC	Master	Inner
8-02090-11161-7	300	25

3/8 and 1/2in Drive Ratchet 11058

- It's like having 2 ratchets in one
- 72 tooth ratchet mechanism engages with just 5 degrees of sweep for work in the tightest spaces
- Contoured cushion grip handle
- Packed bulk in color counter display

UPC	Master	Inner
8-02090-11058-0	24	6



1/4 in. and 3/8 in. Drive Ratchet 11057

- It's like having 2 ratchets in one
- 72 tooth ratchet mechanism engages with just 5 degrees of sweep for work in the tightest spaces
- Contoured cushion grip handle
- Packed bulk in color counter display

UPC	Master	Inner
8-02090-11057-3	48	12



1/4 in. and 3/8 in. Drive Offset Ratchet 11052

- It's like having 2 ratchets in one
- 72 tooth ratchet mechanism engages with just 5 degrees of sweep for work in the tightest spaces
- Contoured cushion grip handle
- Packed bulk in color counter display

UPC	Master	Inner
8-02090-11052-8	48	6



1/4 in. and 3/8 in. Dual Drive Stubby Extendable Ratchet 12071

- 1/4" & 3/8" Drive
- Extends from 6-1/2" to 9" in length
- 72 tooth ratcheting mechanism engages with just 5° of sweep
- Contoured cushion grip handle

UPC	Master	Inner
8-02090-12071-8	48	6



1/4 in. and 3/8 in. Drive Dual Head Stubby Ratchet 11050

- It's like having 2 ratchets in one
- 72 tooth ratchet mechanism engages with just 5 degrees of sweep for work in the tightest spaces
- Contoured cushion grip handle
- Ships bulk in a 6 pc counter display

UPC	Master	Inner
8-02090-11050-4	48	6



1/4 and 3/8in Drive Flex Head Stubby Ratchet 11350

- It's like having 2 ratchets in one
- 72 tooth ratchet mechanism engages with just 5 degrees of sweep for work in the tightest spaces
- Contoured cushion grip handle
- Packed bulk in color counter display

UPC	Master	Inner
8-02090-11350-5	48	6



Offset Micro Bit Driver 11207

- Includes (1) Hex Bit Ratchet and (1) #2 Phillip Bit
- Great for use in today's increasingly compact cars
- Chrome plated polish helps prevent corrosion & rust
- CRV construction
- 60 tooth gear head design
- Reversible Offset



UPC	Master	Inner
8-02090-11207-2	96	12

1/4 in. Drive Offset Micro Ratchet 11206

- Great for use in today's increasingly compact cars
- Ideal for confined under-dash and engine compartment spaces
- Chrome plated polish helps prevent corrosion & rust
- CRV construction
- 60 tooth gear head design
- 12pc Counter Display



UPC	Master	Inner
8-02090-11206-5	96	12

Multi-Purpose Razor Scraper 11030

- Ideal for scraping labels and decals from glass, windshields, etc.
- Comfortable TPR handle for maximum grip
- Includes one extra-heavy duty .020" razor blade - Over twice as thick as a standard razor blade
- Uses Titan replacement blades 11036, 11038 or 11039
- Ships bulk in 6 pc counter display



UPC	Master	Inner
8-02090-11030-6	48	6

Mini Razor Scraper 11031

- Tough polypropylene construction
- TPR comfort sleeve for better grip and more control
- Includes one extra-heavy duty .020" razor blade - over twice as thick as a standard razor blade & protective safety cap
- Uses Titan replacement blades 11036, 11038 or 11039
- Ships bulk in 12 pc counter display



UPC	Master	Inner
8-02090-11031-3	96	12

5-1/2 in. Mini Pry Bar 11505

- 5-1/2 x 7/8" Pry Bar/Scraper
- Rigid stainless steel construction
- Razor sharp scraper edges
- Ideal for nail & tack pulling, prying and scraping
- Packaged in 12 pc counter display



UPC	Master	Inner
8-02090-11505-9	48	12

9-1/4 in. Multi-Purpose Pry Bar 11509

- Overall Size: 9-1/4" x 1-1/2"
- Rigid stainless steel construction with mirror polish finish
- Razor sharp scraper edges
- Ideal for nail & tack pulling, prying and scraping
- Ships bulk in 12pc counter display



UPC	Master	Inner
8-02090-11509-7	48	12

1-1/4 in. Stainless Steel Scraper 11500

- Stainless Steel blade
- Comfortable TPR handle for maximum grip
- Ships bulk in a 6pc counter display

UPC	Master	Inner
8-02090-11500-4	48	6



1-1/4 in. Offset Stainless Steel Scraper 11508

- Rigid stainless steel
- Go-Thru blade with metal capped handle for strength & durability
- Comfortable TPR handle for maximum grip
- Offset design for hard to reach areas
- Ships bulk in a 6pc counter display

UPC	Master	Inner
8-02090-11508-0	48	6



3 in. Offset Stainless Steel Scraper 11504

- Rigid stainless steel blade for strength & durability
- Comfortable TPR handle for maximum grip
- Offset design for hard to reach areas
- Ships in 6 pc counter display

UPC	Master	Inner
8-02090-11504-2	48	6



6-in-1 Painters Tool and Scraper 11510

- Polished stainless steel blade
- Comfortable TPR handle for maximum grip
- 6-in-1 functions include: Wall scraper, paint roller cleaner, paint remover, nail and tack remover, putty and grout remover & putty knife
- Ships bulk in 6 pc counter display

UPC	Master	Inner
8-02090-11510-3	48	6



6 in. Quick-Release Extension Bit Holder 16006

- 6" Quick Release Extension Chuck
- Extended driver for hard to reach areas
- Auto locking drive
- Locking, magnetic, low profile, quick release bit holder

UPC	Master	Inner
8-02090-16006-6	120	20



61 pc. Bit Set 16061

- Includes 2-1/2" magnetic bit holder
- (6) Phillips, (5) Slotted, (13) Star, (6) Pozi, (12) Hex, (7) Tamper Resistant Star, (6) Tamper Resistant Hex, (5) Spanner
- Convenient hangable storage case
- Ships bulk in 4 pc counter display

UPC	Master	Inner
8-02090-16061-5	36	4



3 pc. Damaged Screw Removal Set 11214

- For Phillips, Slotted, Star and Square screws
- Hardened steel bits for secure bit
- 1/4" hex shank fits drills, sockets and screwdrivers
- Sizes #1, #2 and #3 screw removers in handy storage case
- Ships in 8 pack counter display

UPC	Master	Inner
8-02090-11214-0	48	8



22 pc. Titanium Drill Bit 32963

- Titanium nitride coating extends the life of the bit up to six times longer than standard high speed steel drill bits
- Contains: 1/16, 5/64, 3/32, 7/64, 1/8, 9/64, 5/32, 11/64, 3/16, 13/64, 7/32, 15/64, 1/4, 17/64, 9/32, 19/64, 5/16, 21/64, 11/32, 23/64, 3/8"
- Ships in 5 pc counter display

UPC	Master	Inner
8-02090-32963-0	30	5



Mini Sliding Utility Knife 32968

- Quick change blade mechanism
- Smooth retracting/locking blade advance
- Handle Color: Yellow
- Includes 3 replacement blades (Titan #11032)
- Ships in 6pc counter display

UPC	Master	Inner
8-02090-32968-5	96	6



4 pc. Precision Pick Set 32976

- Comfortable TPR sure-grip handles
- Chrome plated shafts
- Includes 4 picks: Curved, 90 degree, Offset and Straight
- Overall Length: 6"
- Ships in 6pc Counter Display

UPC	Master	Inner
8-02090-32976-0	36	6



10 pc. Tamper Resistant Star Key Set 32910

- Drilled tips allow use on tamper resistant security screws
- Chrome vanadium steel construction
- Keys fold compact for easy storage
- Corrosion resistant anodized aluminum holders
- T6, T7, T8, T9, T10, T15, T20, T25, T27 and T30
- Comes in a 6pc display

UPC	Master	Inner
8-02090-32910-4	48	6



33 pc. Security Bit Set 32964

- Includes:
- 2-1/2" magnet bit holders
- #4, #6, #8, and #10 spanner bits
- #6, #8, and #10 TORQ bits
- #1, #2, #3, and #4 Triwing bits
- T8, T10, T15, T20, T25, T30, & T40 Tamper
- Star Bits
- 2, 2.5, 3,4,5, & 6mm Metric Tamper



UPC	Master	Inner
8-02090-32964-7	36	6

2.2x Magnifying Glass 32971

- 2.2x magnification
- Non-distorting optical grade glass lens
- Comfortable TPR rubber grip handle
- TPR rubber framing for extra protection
- Lens measures 2-7/8"
- 7-1/4" overall length
- Ships bulk 8pc counter display



UPC	Master	Inner
8-02090-32971-5	48	8

Backscratcher Magnetic Pick up Tool 32913

- Stainless steel shaft
- Extends 8-1/4" to 27"
- Nickel plated claw
- Comfort grip handle

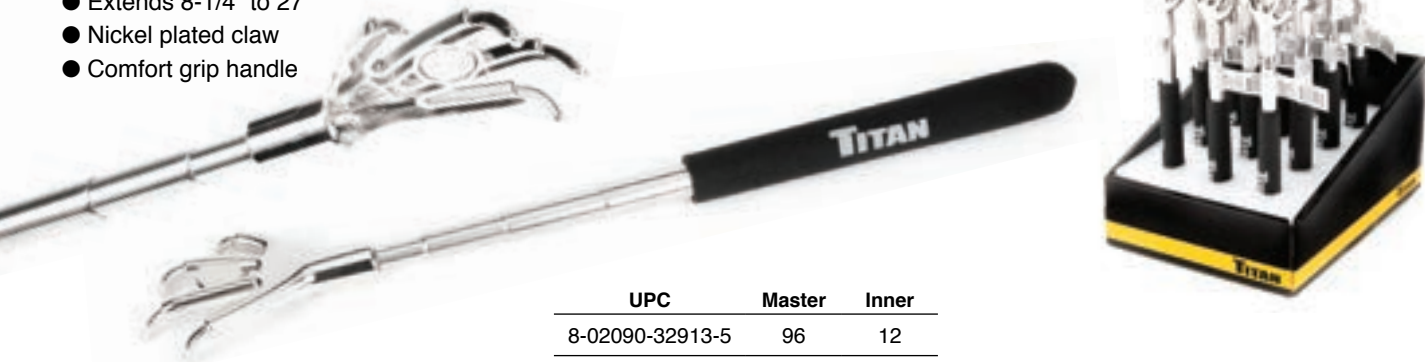

UPC	Master	Inner
8-02090-32913-5	96	12

Mini Razor Scraper 32967

- Includes one heavy duty .020" (#20) razor blade - over twice as thick as a standard razor blade. Titan item #11039
- Ships carded in 6pc counter display



UPC	Master	Inner
8-02090-32967-8	36	6

3 pc. Socket Adapter Set 32975

- Adapts sockets to power drills and drivers
- Includes: 1/4", 1/2 & 3/8" Dr Extension Bar
- 1/4" Shank
- 2-3/4" Overall Length
- Detent ball for secure socket retention
- Ships carded in 6 pc counter display



UPC	Master	Inner
8-02090-32975-3	120	6

4 pc. Socket Adapter Set 32973

- Includes: 3/8" (F) to 1/4" (M), 1/4" (F) to 3/8" (M), 1/2" (F) to 3/8" (M), 3/8" (F) to 1/2" (M)
- Chrome vanadium steel construction
- Ships carded in 6pc counter display



UPC	Master	Inner
8-02090-32973-9	96	6



Pry Bar 32970

- Overall Size: 9 1/4" x 1-1/2"
- Rigid stainless steel construction w/ mirror polished finish
- Razor sharp scraper edges
- Ideal for nail & tack pulling, prying and scraping
- Ships bulk in 6 pc counter display

UPC	Master	Inner
8-02090-32970-8	36	6



12 in. Multi-Purpose Pry Bar 11511

- Rigid stainless steel construction with mirror polish finish
- Razor sharp scraper edges
- Ideal for nail & tack pulling, prying and scraping
- Ships bulk in 6pc counter display

UPC	Master	Inner
8-02090-11511-0	48	6



5-1/2 in. Mini Wrecking Bar 32974

- 5-1/2 x 9/16" Wrecking Bar
- Rigid stainless steel construction
- Razor sharp scraper edges
- Ideal for nail & tack pulling, prying and scraping
- Packaged in 12 pc counter display

UPC	Master	Inner
8-02090-32974-6	72	12



31 pc. Bit Driver Set 32972

- Includes bit driver, convenient bit holder and 30 popular screwdriver bits in the following sizes:
- T9, T10, T15, T20, T25, T27, T30 & T40 Star
- #1 & #2 square drive
- #0, #1, #2 & #3 Phillips
- #0, #1, #2 & #3 Posidriv®
- 3.5, 4.5, 5.5, 6 & 8mm Slotted
- 2, 2.5, 3, 4, 5, 6 & 8mm Hex
- Ships bulk in 6 pc counter display



UPC	Master	Inner
8-02090-32972-2	36	6

6-in-1 Screwdriver 32965

- Soft grip comfort handle for maximum grip
- Includes #1 & #2 Phillips, 1/4" & 3/16" Slotted screwdriver tips and 1/4" & 5/16" Nut drivers
- Ships bulk 9pc counter display



UPC	Master	Inner
8-02090-32965-4	54	9

Stubby Gearless Ratchet Driver 32969

- Gearless design for smooth operation
- Stubby design for tight, confined areas
- Forward/Reversible ratcheting design
- Includes 6 popular bits stored in handle
- Ships bulk 9pcs counter display



UPC	Master	Inner
8-02090-32969-2	54	9

1/4 in. Drive Offset Micro Ratchet 32966

- Reversible
- 60 tooth gearhead design
- High torque
- Small 3" size with offset handle gets into the most confined areas
- Ships on injection hanger in 9pc counter display



UPC	Master	Inner
8-02090-32966-1	54	9

3 pk. Spreader 15073

- Use for spreading and scraping autobody filler mud, pastes, spackling, grout
- Also recommended for drywalling, flooring, and tiling operations
- Includes 3 plastic spreaders: 2-5/8" x 4", 2-3/4" x 5" & 3-5/16" x 6-1/4"



UPC	Master	Inner
8-02090-15073-9	144	6

20 pc. 4 in. Plastic Spreaders 15089

- Use for auto body filler, fiberglass resin, and other compounds
- 4" x 2-1/2"



UPC	Master	Inner
8-02090-15089-0	48	6

Slide Hammer Dent Puller 15077

- Overall length: 14"



UPC	Master	Inner
8-02090-15077-7	24	6

Filler Scoop 15074

- For easy scooping of autobody filler
- Completely cleans can, no waste
- 2-7/8" wide blade, 11-1/2" overall length

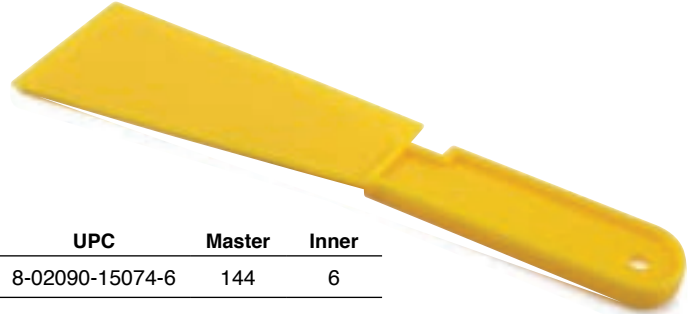

UPC	Master	Inner
8-02090-15074-6	144	6

Suction Cup Dent Puller 15071

- Easily pops most hoods, fenders, roofs & decklids into place
- Lift edge to release suction
- Also functions as a glass holder
- 5" Diameter



UPC	Master	Inner
8-02090-15071-5	72	6

Heavy Duty Suction Cup Dent Puller 15090

- Double handle locking suction cup dent puller
- Designed for auto body repair
- Easily pops most dimpled hoods, fenders, doors, roofs & decklids into place
- 4-1/2" Diameter



UPC	Master	Inner
8-02090-15090-6	72	6

Safety Goggles 15070

- Impact Resistant
- Elastic band for comfort and fit



UPC	Master	Inner
8-02090-15070-8	48	6

3 in. Refinishing Tool 11503

- Use with paint and varnish removers to strip painted surfaces for refinishing
- Tough Polypropylene material



UPC	Master	Inner
8-02090-11503-5	100	10

3 pc. Multi Wedge Pry Tool Set 15047

- Specially designed slim profile
- Shaped for many different applications such as removing dashboards, air vents, door panels, door locks, electronic seat controls, seat levers, center consoles, gear shifter and more
- High quality nylon material prevents scratches to painted surfaces and delicate panel surfaces
- Includes 3 flexible wedge tools



UPC	Master	Inner
8-02090-15047-0	96	12

6 pc. Multi Wedge Pry Tool Set 15048

- Specially designed slim profile
- Shaped for many different applications such as removing dashboards, air vents, door panels, door locks, electronic seat controls, seat levers, center consoles, gear shifter and more
- High quality nylon material prevents scratches to painted surfaces and delicate panel surfaces
- Includes 6 flexible wedge tools



UPC	Master	Inner
8-02090-15048-7	72	12

6 pc. Panel Removal Set 11566

- Specially designed slim profile
- Shaped for many different applications such as removing dashboards, air vents, door panels, door locks, electronic seat controls, seat levers, center consoles, gear shifter and more
- High quality nylon material prevents scratches to painted surfaces and delicate panel surfaces



UPC	Master	Inner
8-02090-11566-0	48	12

7 pc. Mini Precision Trim Tool Set 15068

- Set includes:
- (1) Hammer with non-marring, flexible pry bar handle
- (6) Tips include: (2) White rubber tips - For use on interior trim; (2) Black non-marring tips - For use on interior panels; (1) Brass non-sparking tip - For use on soft metals/panels; (1) Steel tip - For use in dent removal
- (1) Blow mold case
- Use for interior trim, upholstery, and light body repair



UPC	Master	Inner
8-02090-15068-5	24	6

Chisel Tip Wrecking Knife 17108

- 4" Blade
- Stainless steel construction
- Strikeable end
- Chisel-tipped
- Includes holster
- Can be used for: chiseling, prying, scraping, coring, cutting, and more



UPC	Master	Inner
8-02090-17108-6	24	6

All-Purpose Wrecking Knife 17109

- 4" Blade
- Stainless steel construction
- Strikeable end
- Includes holster
- Can be used for: prying, scraping, coring, cutting, and more



UPC	Master	Inner
8-02090-17109-3	12	6

7 pc. Autobody Hammer Set 15084

- Includes: bumping hammer, pick & finish hammer, reverse curve hammer, utility dolly, double end dolly, shrinking dolly, curve dolly, form-fitted mold case
- Fiberglass hammer handles with non-slip grip
- Heat-treated, dropped, forged steel dollies and hammers



UPC	Master	Inner
8-02090-15084-5	4	1

Heel Dolly 15085

- For smoothing dings and dents in sheet metal or steel
- Straight side of heel dolly is great for bending tight angles



UPC	Master	Inner
8-02090-15085-2	18	6

Wedge Dolly 15086

- Slender general purpose dolly
- Used for beads or flanges on fenders
- Thin edge useful for corners
- Flat side for long curve of fender



UPC	Master	Inner
8-02090-15086-9	24	3

General Purpose Dolly 15087

- Ideal for shaping and molding metal
- Several differently crowned working faces



UPC	Master	Inner
8-02090-15087-6	12	6

Straight Finishing Hammer 15079

- Drop forged steel head
- Rubber grip handle
- Square head, flat face, blunt head, chisel point



UPC	Master	Inner
8-02090-15079-1	36	6

Shrinking Hammer 15080

- Drop forged steel head
- Mirror polished
- Rubber grip handle



UPC	Master	Inner
8-02090-15080-7	36	6

Pick Finishing Hammer 15081

- Long-reach, thin point for low spot on low-crown panels
- Rubber grip handle



UPC	Master	Inner
8-02090-15081-4	36	6

8 oz. Rubber Hammer 15082

- Double-faced solid rubber head
- Rubber grip handle



UPC	Master	Inner
8-02090-15082-1	36	6

17 in. x 2-3/4 in. Flexible Sanding Block 19951

- Soft molded foam block for maximum comfort and grip
- Made of tough and durable polyurethane material
- For use on flat or contoured surfaces
- Works with Vaper Wet/Dry Adhesive Back Sandpaper
- #51080 80 Grit, #51150 150 Girt, #51240 240 Grit, #51320 320 Grit



UPC	Master	Inner
8-02090-19951-6	24	4

Flexible Sander 15078

- Flexible design allows for optimal sanding of flat and curved surfaces
- Ergonomic dual handle design for comfort and maximum control
- Spring loaded clamps for simple replacement of sandpaper
- 9-1/2" x 2-3/4" Pad size

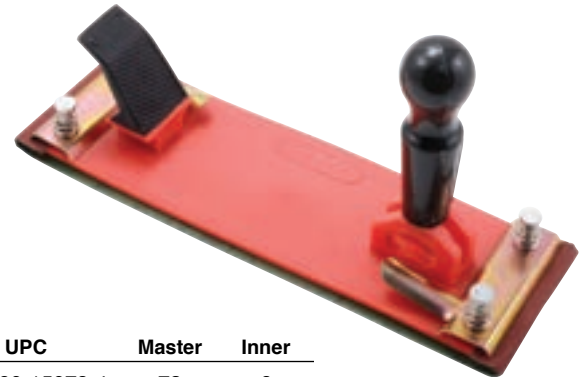

UPC	Master	Inner
8-02090-15078-4	72	6

7 in. x 4 in. Flexible Sanding Block 19959

- Soft molded foam block for maximum comfort and grip
- Made of tough and durable polyurethane material
- For use on flat or contoured surfaces
- Works with Vaper Wet/Dry Adhesive Back Sandpaper
- #59080 80 Grit, #59150 150 Girt, #59240 240 Grit, #59320 320 Grit



UPC	Master	Inner
8-02090-19959-2	24	6

5 in. x 2-3/4 in. Flexible Sanding Block 19952

- Soft molded foam block for maximum comfort and grip
- Made of tough and durable polyurethane material
- For use on flat or contoured surfaces
- Works with Vaper Wet/Dry Adhesive Back Sandpaper
- #52080 80 Grit, #52150 150 Girt, #52240 240 Grit, #52320 320 Grit

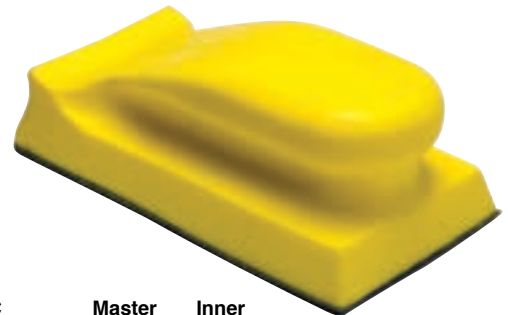

UPC	Master	Inner
8-02090-19952-3	36	6

10 in. 3-Position File Holder 15075

- 3-position file holder
- 10" flat blade
- For planing, shaping, filing or shaving

UPC	Master	Inner
8-02090-15075-3	48	6



10 in. Shaper File Blades

- For use with TITAN # 15075
- For planing, shaping, filing or shaving



Part #	Type	UPC	Master	Inner
15072	Flat	8-02090-15072-2	200	10
15088	Round	8-02090-15088-3	200	10

80 Grit Sand Paper

- For metal, plastic and fiberglass surfaces
- Adhesive backing for quick and easy paper changes

51080

- Works with Vaper Hand Sanding Block #19951 or similar models



52080

- Works with Vaper Hand Sanding Block #19952 or similar models



59080

- Works with Vaper Hand Sanding Block #19959 or similar models



Part #	Sizes	UPC	Master	Inner
51080 5-pc 17 in.	17-3/8 x 2-3/4 inch (440 x 70 mm)	8-02090-51080-9	200	25
52080 5-pc 5 in.	5 x 2-3/4 inch (135 x 70 mm)	8-02090-52080-8	200	25
59080 5-pc 7 in.	7 x 4 inch (180 x 100 mm)	8-02090-59080-1	200	25

150 Grit Sand Paper

- For metal, plastic and fiberglass surfaces
- Adhesive backing for quick and easy paper changes

51150

- For use with Vaper Hand Sanding Block #19951 or similar models



52150

- For use with Vaper Hand Sanding Block #19952 or similar models



59150

- For use with Vaper Hand Sanding Block #19959 or similar models



Part #	Sizes	UPC	Master	Inner
51150 5-pc 17 in.	17-3/8 x 2-3/4 inch (440 x 70 mm)	8-02090-51150-9	200	25
52150 5-pc 5 in.	5 x 2-3/4 inch (135 x 70 mm)	8-02090-52150-8	200	25
59150 5-pc 7 in.	7 x 4 inch (180 x 100 mm)	8-02090-59150-1	200	25

240 Grit Sand Paper

- For metal, plastic and fiberglass surfaces
- Adhesive backing for quick and easy paper changes

51240

- For use with Vaper Hand Sanding Block #19951 or similar models



52240

- For use with Vaper Hand Sanding Block #19952 or similar models



59240

- For use with Vaper Hand Sanding Block #19959 or similar models



Part #	Sizes	UPC	Master	Inner
51240 5-pc 17 in.	17-3/8 x 2-3/4 inch (440 x 70 mm)	8-02090-51240-7	200	25
52240 5-pc 5 in.	5 x 2-3/4 inch (135 x 70 mm)	8-02090-52240-6	200	25
59240 5-pc 7 in.	7 x 4 inch (180 x 100 mm)	8-02090-59240-9	200	25

320 Grit Sand Paper

- For metal, plastic and fiberglass surfaces
- Adhesive backing for quick and easy paper changes

51320

- For use with Vaper Hand Sanding Block #19951 or similar models



52320

- For use with Vaper Hand Sanding Block #19952 or similar models



59320

- For use with Vaper Hand Sanding Block #19959 or similar models



Part #	Sizes	UPC	Master	Inner
51320 5-pc 17 in.	17-3/8 x 2-3/4 inch (440 x 70 mm)	8-02090-51320-6	200	25
52320 5-pc 5 in.	5 x 2-3/4 inch (135 x 70 mm)	8-02090-52320-5	200	25
59320 5-pc 7 in.	7 x 4 inch (180 x 100 mm)	8-02090-59320-8	200	25

Multi-Grade Steel Wool 15092

- Includes three grades
- Coarse - stripping grade
- Medium - between coats
- Fine - finishing grade



UPC	Master	Inner
8-02090-15092-0	24	1

3 pc. Mini Wire Brush Set 51505

- Set includes:
 - (1) Stainless Steel Brush
 - (1) Brass Brush
 - (1) Nylon Brush
- Overall length: 4 in.

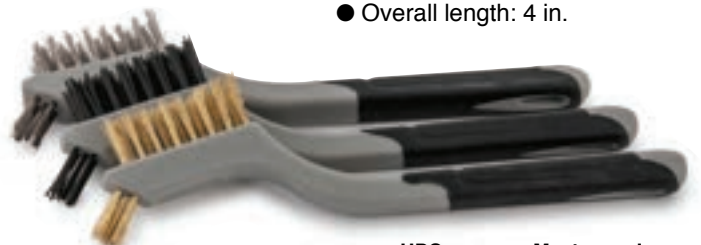

UPC	Master	Inner
8-02090-51505-7	144	24

96 pc. Blade Fuse Assortment 45227



- Set includes 12 each: 3A (Violet), 5A (Orange), 7.5A (Brown), 10A (Red), 15A (Blue), 20A (Yellow), 25A (Clear), 30A (Green)
- Zinc electrodes
- Convenient re-sealable plastic case
- Made in Taiwan

UPC	Master	Inner
8-02090-45227-7	20	5

88 pc. Master Auto Fuse Assortment 45230



- 5 EACH- Mini Blade Fuses: 3A (Violet), 5A (Orange), 7.5A (Brown), 10A (Red), 15A (Blue), 20A (Yellow), 25A (Clear), 30A (Green)
- 5 EACH- Blade Fuses: 3A (Violet), 5A (Orange), 7.5A (Brown), 10A (Red), 15A (Blue), 20A (Yellow), 25A (Clear), 30A (Green)
- 1 EACH- Maxi Blade Fuses: 20A (Yellow), 30A (Green), 40A (Orange), 50A (Red), 60A (Blue), 70A (Tan), 80A (Clear), 100A (Purple)
- Zinc electrode
- Convenient re-sealable plastic case
- Made in Taiwan

UPC	Master	Inner
8-02090-45230-7	24	6

36 pc. Low Profile Mini Fuse Assortment 45237



- Set Includes: (5) LED Mini Plug-In Fuse- 5A (Orange), (5) LED Mini Plug-In Fuse- 7.5A (Brown), (5) LED Mini Plug-In Fuse- 10A (Red), (5) LED Mini Plug-In Fuse- 15A (Blue), (5) LED Mini Plug-In Fuse- 20A (Yellow), (5) LED Mini Plug-In Fuse- 25A (Natural), (5) LED Mini Plug-In Fuse- 30A (Green), (1) Fuse Puller
- Zinc Alloy Electrodes
- Convenient re-sealable plastic case
- Made in Taiwan

UPC	Master	Inner
8-02090-45237-6	72	12

24 pc. Maxi Blade Fuse Assortment 45232



- Set includes 3 each: 20A (Yellow), 30A (Green), 40A (Orange), 50A (Red), 60A (Blue), 70A (Tan), 80A (Clear), 100A (Purple)
- Zinc electrodes
- Convenient re-sealable plastic case
- Made in Taiwan

UPC	Master	Inner
8-02090-45232-1	20	5

71 pc. Micro 2-Fuse Assortment
45231



- Contains: (10) Each - 5A (Orange), 7.5A (Brown), 10A (Red), 15A (Blue), 20A (Yellow), 25A (Natural), 30A (Green), (1) Fuse Puller
- Voltage Rating: 32V
- Body Material: Nylon
- Material: Zinc Alloy
- Made in Taiwan

UPC	Master	Inner
8-02090-45231-4	72	12

96 pc. Mini Blade Fuse Assortment
45229



- Set includes 12 each: 3A (Violet), 5A (Orange), 7.5A (Brown), 10A (Red), 15A (Blue), 20A (Yellow), 25A (Clear), 30A (Green)
- Zinc electrodes
- Convenient re-sealable plastic case
- Made in Taiwan

UPC	Master	Inner
8-02090-45229-1	20	5

Dual-Wall Heat Shrink Tube Assortments

- Dual Wall
- Waterproof Polyefin heat shrink tubes
- Operating Temperature: -49°F ~ 257°F (-45°C ~ 125°C)
- Shrink Temperature: Starts at 158°F (70°C) Ends at 248°F (120°C)
- 3:1 Shrink Ratio
- Maximum Electrical Rating: 600 Volts
- U.L. Approved

106 pc. 45239

- (10) 5/16" x 2-61/64" (7.9mm x 75mm) BLACK (8) 3/8" x 2-61/64" (9.5mm x 75mm) BLACK (6) 1/2" x 2-61/64" (12.7mm x 75mm) BLACK (30) 1/8" x 1-25/32" (3.2mm x 45mm) RED/BLACK: 15 of each color (16) 3/16" x 1-25/32" (4.8mm x 45mm) RED/BLACK: 8 of each color (12) 1/4" x 1-25/32" (6.4mm x 45mm) RED/BLACK: 6 of each color (10) 5/16" x 1-25/32" (7.9mm x 45mm) RED (8) 3/8" x 1-25/32" (9.5mm x 45mm) RED



UPC	Master	Inner
8-02090-45209-3	30	1

22 pc. 45209

- (Includes: (5) Black: 1/2" x 6" (12.7mm x 152mm) (2) Black: 3/4" x 6" (19.1mm x 152mm) (4) Black: 1" x 3" (25.4mm x 76mm) (5) Red: 1/2" x 6" (12.7mm x 152mm) (2) Red: 3/4" x 6" (19.1mm x 152mm) (4) Red: 1" x 3" (25.4mm x 76mm)



UPC	Master	Inner
8-02090-45239-0	40	10

171 pc. Heat Shrink Tube Assortment 45238

- U.L. Approved
- (25 of each): 5/64" x 1-3/16" (2mm x 30mm) GREEN, WHITE, RED & BLACK
- (10) 5/32" X 2-3/8" (4mm x 60mm) BLUE (10) 3/16" x 2-3/8" (4.5mm x 60mm) BLACK (8) 13/64" x 2-3/8" (5mm x 60mm) RED (6) 15/64" x 2-3/8" (6mm x 60mm) WHITE (11) 23/64" x 3-9/16" (9mm x 90mm) BLUE (11) 5/16" x 3-9/16" 8mm x 90mm WHITE (1) 25/64" x 39-3/8" (10mm x 1M) BLACK (7) 23/32" x 3-9/16" (18mm x 90mm) YELLOW
- (7) 15/32" x 3-9/16" (12mm x 90mm) GREEN
- UL Approved Polyefin heat shrink tubes
- Operating Temperature: -67°F ~ 257°F
- Shrink Temperature: Starts at 158°F Ends at 230°F
- 2:1 Shrink Ratio
- Maximum Electrical Rating: 600 Volts



UPC	Master	Inner
8-02090-45238-3	40	10



158 pc. Wire Nut Assortment 45339

- Contains: (40) Gray: #22 to #16 AWG Wire (300v), (40) Blue: #22 to #14 AWG Wire (300v), (50) Orange: #22 to #14 AWG Wire (600v), (18) Yellow: #18 to #12 AWG Wire (600v), (10) Red: #18 to #10 AWG Wire (600v)
- UL Listed and CSA Certified
- Flame-Retardant Polypropylene Shell
- Reuseable

UPC	Master	Inner
8-02090-45339-7	24	6

110 pc. Metric Grease Fit Assortment 45274

- Straight includes:
- 30pc M6x1, 20pc M8x1, 20pc M10x1, 90° includes: 20pc M6x1, 10pc M8x1, 10pc M10x1
- Convenient re-sealable plastic case



UPC	Master	Inner
8-02090-45274-1	24	6

70 pc. Grease Fitting Assortment 45215

- Contains: (20) 1/4"-28 Straight, (20) 1/4"-28 45°, (5) 1/4"-28 90°, (10) 1/8"-27 Straight, (5) 1/8"-27 45°, (5) 1/8"-27 90°, (10) 6mm x 1.0 Straight, (5) 8mm x 1.0 Straight, (5) 10mm x 1.0 Straight
- Convenient Re-sealable plastic case



UPC	Master	Inner
8-02090-45215-4	24	6

100 pc. Metric Nylon Locknut Assortment 45243

- Contains: 25) M4, (25) M5, (20) M6, (15) M8, (10) M10, (5) M12
- Convenient re-sealable plastic case



UPC	Master	Inner
8-02090-45243-7	24	6

20 pc. Hose Clamp Assortment 45207

- Set includes:
- (4) 1in, (2) 1-1/4in, (2) 1-3/4in, (4) 2in, (2) 2-1/2in, (2) 3in, (2) 3-1/2in, (2) 4in



UPC	Master	Inner
8-02090-45207-9	24	6

34 pc. Hose Clamp Assortment 45348

- Contains: (8) 5/8" 16mm, (8) 3/4" 19mm, (6) 7/8" 22mm, (4)1" 25mm, (4)1-1/16" 27mm, (4)1-1/4" 32mm



UPC	Master	Inner
8-02090-45348-9	24	6

550 pc. Nail Assortment 45240

- Contains:
- Brad Nails, (100) 3/64" x 7/8", (80) 3/64" x 1", (80) 1/16" x 1-1/4", (50) 1/16" x 1-1/2", (30) 3/32" x 1-1/4", (20) 3/32" x 2"
- Finishing Nails, (80) 3/64" x 1" & (80)3/64" x 1-1/4"
- Masonry Nails, (30) 3/32" x 1-1/2"
- Convenient re-sealable plastic case



UPC	Master	Inner
8-02090-45240-6	24	6

475 pc. Metric Nut and Bolt Assortment **45250**

- Contains:
- Machine Screws: (20 ea) M4 x 16, M4 x 25, M5 x 20, M5 x 25, M6 x 2
- Lock Washers: (50) M4, (50) M5, (25) M6
- Flat Washers
- Hex Nuts
- Convenient re-sealable plastic case



240 pc. Zinc USS Nut and Bolt Assortment **45333**

- Bolts (10) #8 x 1/2", (10) #8 x 3/4", (10) #10 x 5/8", (10) #10 x 1", (10) 1/4" x 3/4", (10) 1/4" x 1-1/4", (5) 5/16" x 1", (5) 5/16" x 1-1/2", (5) 3/8" x 5/8", (5) 3/8" x 1-1/2"
- Hex Nuts: (20) #8, (20) #10, (20) #1/4", (10) #5/16", (10) #3/8"
- Washers: (20) #8, (20) #10, (20) #1/4", (10) #5/16", (10) #3/8"
- Zinc Oxide Finish
- Convenient re-sealable plastic case



UPC	Master	Inner
8-02090-45250-5	24	6

UPC	Master	Inner
8-02090-45333-5	24	6

240 pc. Zinc Metric Nut and Bolt Assortment **45334**

- Contains Bolts: (10) M4 x 12M, (10) M4 x 20M, (10) M5 x 16M, (10) M5 x 25M, (10) M6 x 20M, (10) M6 x 30M, (5) M8 x 25M, (5) M8 x 40M, (5) M10 x 16M, (5) M10 x 40M
- Hex Nuts: (20) M4, (20) M5, (20) M6, (10) M8, (10) M10,
- Washers: (20) M4, (20) M5, (20) M6, (10) M8, (10) M10
- Zinc Oxide Finish
- Convenient re-sealable plastic case



UPC	Master	Inner
8-02090-45334-2	12	6

270 pc. HNBR O-Ring Assortment **45201**

- For R134A usw with Air Conditioning systems
- (20) 7/32" x 1/16" (5.29 x 1.78) (20) 1/4" x 1/16" (6.07 x 1.78)
- (20) 9/32" x 5/64" (6.80 x 1.90) (20) 5/16" x 1/16" (7.65 x 1.78)
- (20) 5/16" x 5/64" (7.80 x 1.90) (20) 5/16" x 5/64" (8.00 x 2.00)
- (20) 11/32" x 5/64" (8.80 x 1.90) (10) 3/8" x 5/64" (10.00 x 2.00)
- (15) 7/16" x 1/16" (10.82 x 1.78) (15) 7/16" x 5/64" (11.00 x 2.00)
- (15) 7/16" x 3/32" (10.77 x 2.62) (15) 1/2" x 5/64" (12.00 x 2.00)
- (10) 9/16" x 1/16" (13.90 X 1.80)(10) 9/16" x 3/32" (13.95 x 2.62)
- (10) 5/8" x 5/64" (15.00 x 2.00) (10) 11/16" x 1/16" (17.17 x 1.78) (10) 11/16" x 1/8" (17.04 x 3.53) (10) 11/16" x 5/64" (17.00 x 2.00)

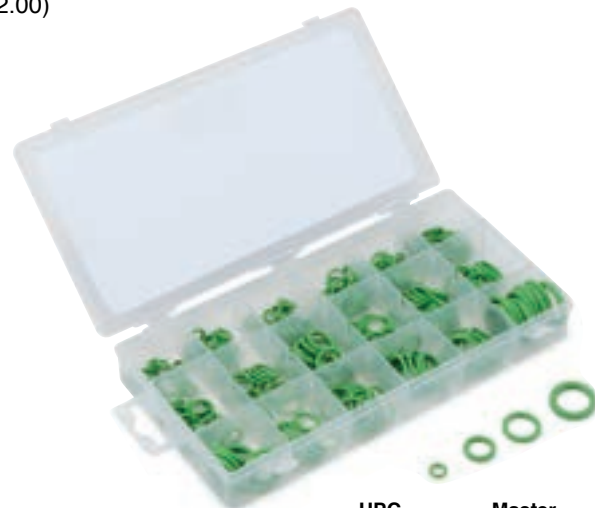

UPC	Master	Inner
8-02090-45201-7	24	6

407 pc. SAE O-Ring Assortment 45202

- Contains: (20) #006, (20) #008, (20) #010, (20) #011, (20) #012, (20) #014, (13) # 110, (13) # 111, (13) #112, (13) #113, (13) #114, (13) #115, (13) #116, (13) #117, (13) #118, (10) #210, (10) #212, (10) #213, (10) #214, (10) #215, (10) #216, (10) #217, (10) #218, (10) #219, (10) #220, (10) #221, (10) #222, (10) #223, (10) #224, (10) #225, (10) #226
- Convenient re-sealable plastic case

UPC	Master	Inner
8-02090-45202-4	24	6



419 pc. Metric O-Ring Assortment 45203

- Contains: (20) 3.00x1.78, (20) 4.40x2.62, (18) 5.00x2.62, (23) 7.00x1.78, (23) 10.00x1.78, (23) 13.00x1.78, (14) 10.00x2.62, (13) 11.00x2.62, (14) 13.00x2.62, (13) 14.00x2.62, (14) 16.00x2.62, (14) 18.00x2.62, (13) 19.00x2.62, (14) 21.00x2.62, (13) 22.00x2.62, (10) 18.00x3.53, (10) 20.00x3.53, (10) 22.00x3.53, (10) 23.50x3.53, (10) 25.00x3.53, (10) 26.50x3.53, (10) 28.00x3.53, (10) 30.00x3.53, (10) 31.00x3.53, (10) 33.00x3.53, (10) 34.50x3.53, (10) 36.00x3.53, (10) 38.00x3.53, (10) 41.00x3.53, (10) 44.00x3.53, (10) 47.00x3.53, (10) 50.00x3.53
- Convenient re-sealable plastic case

UPC	Master	Inner
8-02090-45203-1	24	6



225 pc. SAE O-Ring Assortment 45225

- Contains:
- (10) 3/32" x 15/64", (20) 1/8" x 1/4", (20) 5/32" x 9/32", (20) 3/16" x 5/16", (15) 7/32" x 11/32", (15) 1/4" x 3/8", (15) 5/16" x 7/16", (10) 3/8" x 1/2", (10) 3/8" x 9/16", (10) 7/16" x 5/8", (10) 1/2" x 11/16", (10) 9/16" x 3/4", (10) 5/8" x 3/4", (10) 5/8" x 13/16", (10) 11/16" x 7/8", (10) 3/4" x 15/16", (10) 3/4" x 1", (10) 13/16" x 1-1/16
- Convenient re-sealable plastic case

UPC	Master	Inner
8-02090-45225-3	24	6



20 pc. Clevis Pin Assortment 45249

- Contains (1pc ea): 1/4" x 1-1/4", 1/4" x 2", 5/16" x 1", 5/16" x 1-1/4", 3/8" x 1", 3/8" x 2-3/8"
- Contains (2pcs ea): 1/4" x 1-1/2", 5/16" x 1-1/2", 5/16" x 2", 5/16" x 2-1/4", 5/16" x 2-1/2", 5/16" x 3", 3/8" x 2"
- Convenient re-sealable plastic case



UPC	Master	Inner
8-02090-45249-9	24	6

1000 pc. Cotter Pin Assortment 45204

- Contains: (380) 1/16" x 1", (240) 3/32" x 1", (140) 3/32" x 1-1/2", (115) 1/8" x 1-1/4", (75) 1/8" x 2", (50) 5/32" x 2-1/2"
- Convenient re-sealable plastic case



UPC	Master	Inner
8-02090-45204-8	24	6

555 pc. Cotter Pin Assortment 45205

- Contains: (150) 1/16" x 1", (150) 3/32" x 1", (100) 3/32" x 1-1/2", (75) 1/8" x 1-1/4", (50) 1/8" x 2", (30) 5/32" x 2-1/2"
- Convenient re-sealable plastic case



UPC	Master	Inner
8-02090-45205-5	24	6

144 pc. Large Cotter Pin Assortment 45206

- Contains: (50) 1/8" x 2", (30) 5/32" x 2-1/2", (20) 3/16" x 3", (20) 1/4" x 2", (16) 1/4" x 3", (8) 5/16" x 2-1/2"
- Convenient re-sealable plastic case



UPC	Master	Inner
8-02090-45206-2	12	6

**555 pc. Large Stainless Steel
Cotter Pin Assortment 45245**

- Contains: (150) 1/16" x 1", (150) 3/32" x 1", (100) 3/32" x 1-1/2", (75) 1/8" x 1/4", (50) 1/8" x 2", (30) 5/32" x 2-1/2"
- Stainless Steel
- Convenient re-sealable plastic case



UPC	Master	Inner
8-02090-45245-1	24	6

150 pc. Pin Hitch Assortment 45210

- Contains: (42) 3/32" x 1-3/16", (30) 5/64" x 1-5/16", (25) 5/64" x 1-9/16", (25) 7/64" x 1-5/8", (20) 9/64" x 1-3/4", (8) 5/32" x 2-15/16"
- Convenient re-sealable plastic case



UPC	Master	Inner
8-02090-45210-9	24	6

120 pc. Roll Pin Assortment 45342

- Contains (5pcs ea): 1/8" x 5/8", 1/8" x 1", 1/8" x 1-1/4", 3/16" x 5/8", 3/16" x 1", 3/16" x 1-1/4"
- Contains (4pcs ea): 1/16" x 3/16", 1/16" x 3/4", 1/16" x 5/16", 3/32" x 5/8", 3/32" x 1", 3/32" x 1-1/4", 5/64" x 1/4", 5/64" x 1/2", 5/64" x 1", 5/32" x 5/8", 5/32" x 1", 5/32" x 1-1/2", 7/32" x 5/8", 7/32" x 1-1/4", 7/32" x 1-3/4", 1/4" x 5/8", 1/4" x 1-1/4", 1/4" x 1-3/4", 5/16" x 3/4", 5/16" x 1-1/2", 5/16" x 2"
- Contains (2pcs ea): 3/8" x 3/4", 3/8" x 1-1/2", 3/8" x 2"
- Convenient re-sealable plastic case



UPC	Master	Inner
8-02090-45342-7	24	6

**200 pc. Hex Head Screw
Assortment 45220**

- Includes: (30) #8 x 1/2", (30) #8 x 5/8", (30) #8 x 3/4", (30) #8 x 1", (20) #10 x 1/2", (20) #10 x 5/8", (20) #10 x 3/4", (20) #10 x 1"
- Comes organized in a convenient re-sealable plastic case



UPC	Master	Inner
8-02090-45220-8	24	6

125 pc. Rubber Grommet Assortment 45214

- Contains:
 - Rubber Grommets: (15) 1/8" x 1/4", (10) 7/32" x 5/16", (7) 9/32" x 1/2", (3) 5/16" x 9/16", (6) 3/8" x 15/32", (5) 3/8" x 1/2", (3) 3/8" x 13/16", (4) 7/16" x 3/4", (3) 1/2" x 19/32", (3) 5/8" x 31/32", (2) 3/4" x 15/16"
 - Rubber Plugs: (20) 9/32", (20) 3/8", (10) 1/2", (5) 5/8", (4) 3/4", (3) 7/8", (2) 1"
- Convenient re-sealable plastic case



110 pc. Rubber Grommet Assortment 45236

- Contains: (25) 1/4", (20) 5/16", (20) 3/8", (20) 7/16", (10) 1/2", (5) 5/8", (5) 7/8", (5) 1"
- Convenient re-sealable plastic case



UPC	Master	Inner
8-02090-45214-7	24	6

UPC	Master	Inner
8-02090-45236-9	24	6

160 pc. Metric Hex Head Screw Assortment 45251

- Contains:
 - (15) 3mm x 5mm, (15) 4mm x 5mm, (10) 5mm x 6mm, (20) 6mm x 6mmF, (15) 6mm x 6mm, (10) 6mm x 10mm, (20) 8mm x 10mm, (15) 8mm x 10mmF, (10) 8mm x 12mm, (10) 10mm x 10mm, (10) 10mm x 10mmF, (10) 10mm x 12mm
- Convenient Re-sealable plastic case



UPC	Master	Inner
8-02090-45251-2	24	6

160 pc. SAE Hex Head Screw Assortment 45235

- USS Thread: (20) 1/4" x 1/4"-20, (10) 1/4" x 3/8"-20, (20) 5/16" x 3/8"-18, (10) 5/16" x 1/2"-18, (10) 3/8" x 3/8"-16, (10) 3/8" x 1/2"-18
- SAE Thread: (15) 1/8" x 3/16"-40, (10) 3/16" x 1/4"-24, (15) 5/32" x 3/16"-32, (15) 1/4" x 1/4"-28, (15) 5/16" x 3/8"-24, (10) 3/8" x 3/8"-24
- Convenient Re-sealable plastic case



UPC	Master	Inner
8-02090-45235-2	24	6

500 pc. Aluminum Rivet Assortment 45228

- Contains: (120) 1/8" x 1/4", (120) 1/8" x 5/16", (120) 1/8" x 3/8", (70) 3/16" x 5/16", (70) 3/16" x 3/8"
- Rustproof Aluminum Rivet Body
- Steel Mandrel
- Convenient Re-sealable plastic case



UPC	Master	Inner
8-02090-45228-4	24	6

106 pc. Metric Socket Screw Assortment 45307

- Contains: (25) M4 x 12, (20) M5 x 25, (10ea) M6 x 12, M6 x 25, (5ea) M8 x 25, M8 x 40, (3ea) M10 x 25, M10 x 40
- Convenient re-sealable plastic case



UPC	Master	Inner
8-02090-45307-6	24	6

300 pc. E-Clip Assortment 45208

- Contains: (30) 1/16", (30) 1/8", (40) 3/16", (50) 1/4", (50) 3/8", (40) 1/2", (20) 5/8", (20) 3/4", (20) 7/8"
- Black Oxide Finish
- Convenient re-sealable plastic case



UPC	Master	Inner
8-02090-45208-6	24	6

300 pc. Snap Ring Assortment 45212

- Contains:
INTERNAL (15) 3/16", (20) 3/8", (15) 7/16", (15) 15/32", (25) 3/4", (20) 7/8"
EXTERNAL (20) 1/8", (10) 5/32", (25) 1/4", (15) 5/16", (25) 1/2", (15) 9/16", (20) 5/8", (15) 13/16", (15) 1", (15) 1-1/16", (10) 1-1/8", (5) 1-1/4"
- Convenient re-sealable plastic case



UPC	Master	Inner
8-02090-45212-3	24	6

295 pc. Shop Assortment 45343

- Retaining Ring (12 pcs ea size) 3/8", 1/2", 5/8", & 3/4"
- E-Clip (20 pcs ea size) 1/4" & 3/8"
- Roll Pin (12 pcs ea size) 1/8"x5/8", 1/8"x1", 5/32"x5/8", 5/32"x1", 3/16x5/8", 3/16"x1"
- Woodruff Key (25 pcs ea size) 3/32"x3/8", 3/32"x1/2", 1/8"x1/2", 1/8"x5/8", (10 pcs) 3/16"x3/4"
- Convenient re-sealable plastic case



UPC	Master	Inner
8-02090-45343-4	24	6

200 pc. Spring Assortment 45200

- Extension Springs: (8) 3/16" x 1-3/4", (12) 5/32" x 3-1/8", (10) 13/64" x 13/16", (10) 7/32" x 1", (10) 9/32" x 1-1/2", (12) 9/32" x 2-13/16", (12) 11/32" x 1-27/32", (10) 11/32" x 1-7/16", (10) 1/4" x 7/8", (8) 5/16" x 1-1/8", (10) 5/16" x 1-1/4", (12) 5/16" x 1-3/4"
- Compression Springs: (10) 7/32" x 11/16", (10) 7/32" x 1-1/2", (10) 9/32" x 1/2", (10) 9/32" x 3/4", (10) 1/4" x 13/32", (8) 23/64" x 1-3/8", (6) 3/8" x 5/8", (12) 3/8" x 3/4"
- Convenient re-sealable case



UPC	Master	Inner
8-02090-45200-0	24	6

80 pc. Vacuum Cap Assortment 45252

- Contains: (20) 3/16", (20) 5/32", (20) 7/32", (10) 1/4", (5) 5/16", (5) 3/8"
- Constructed of heat resistant Buna-N Rubber
- Convenient re-sealable plastic case



UPC	Master	Inner
8-02090-45252-9	24	6

110 pc. Copper Washer Assortment 45217

- Contains: (30) 1/4" Washer, (25) 5/16" Washer, (20) 3/8" Washer, (15) 7/16" Washer, (10) 1/2" Washer, (10) 5/8" Washer
- Convenient re-sealable plastic case



UPC	Master	Inner
8-02090-45217-8	24	6

Ceramic Magnetic Blocks

- Designed for lifting holding, retrieving and separating metal objects

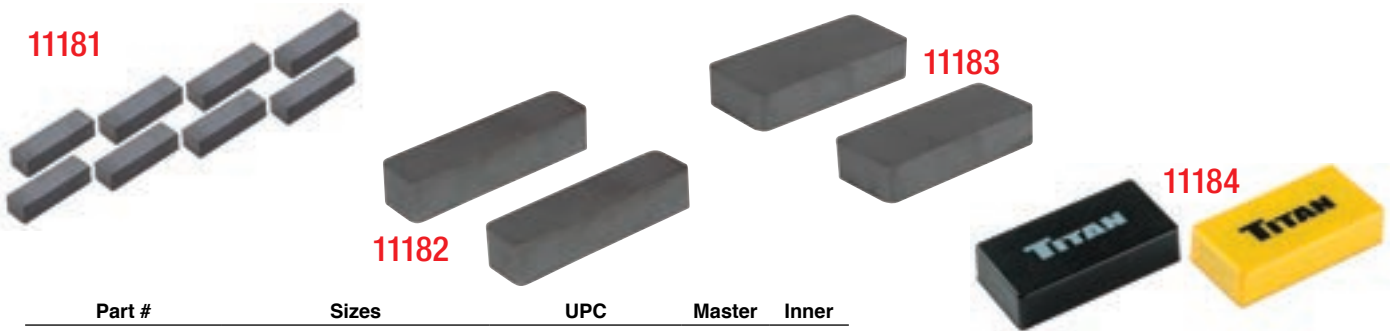

Part #	Sizes	UPC	Master	Inner
11181 8-pc	1/4in wide x 7/8in long x 3/16in deep	8-02090-11181-5	192	12
11182 2-pc	3/8in wide x 7/8in long x 3/8in deep	8-02090-11182-2	192	12
11183 2-pc	3/8in wide x 7/8in long x 3/8in deep	8-02090-11183-9	96	12
11184 2-pc	7/8in wide x 1-7/8in long x 3/8in	8-02090-11184-6	96	12

Ceramic Magnetic Discs

- Designed for lifting holding, retrieving and separating metal objects
- Extremely strong magnets
- Caution: Not for children



Part #	Sizes	UPC	Master	Inner
11136 40-pc	1/2" wide x 3/16" deep	8-02090-11136-5	96	12
11137 2-pc	1-1/2" wide x 3/16" deep	8-02090-11137-2	192	12
11171 10-pc	1/2" wide x 3/16" deep	8-02090-11171-6	192	12
11172 8-pc	3/4"	8-02090-11172-3	192	12
11173 6-pc	1" wide x 5/32" deep	8-02090-11173-0	192	12
11174 6-pc	3/4" wide x 1/8" deep	8-02090-11174-7	192	12
11175 2-pc	1-3/4" wide x 1/4" deep	8-02090-11175-4	192	12

Rare Magnetic Discs

- Ultra strength magnet ideal for holding surfaces with high iron content
- Caution: VERY STRONG MAGNETS! Very Brittle. Can break easily. Slide magnets to pull apart. Not for Children`

11132



11134



11135



11176



11177



Part #	Sizes	UPC	Master	Inner
11132 10-pc 9.5mm	3/8" wide x 3/8" deep	8-02090-11132-7	192	12
11134 10-pc 8mm	5/16" wide x 1/8" deep	8-02090-11134-1	192	12
11135 12-pc 9.5mm	3/8" wide x 1/8" deep	8-02090-11135-8	192	12
11176 4-pc 12mm	1/2" wide x 1/8" deep	8-02090-11176-1	192	12
11176 3-pc 18mm	11/16" wide x 1/8" deep	8-02090-11177-8	192	12

2 pc. Magnetic Clips

- Attach to tool bins, shop cabinets, file cabinets, refrigerators and other ferrous metal surfaces
- Holds manuals, calendars, notepads and more

11140



11141



11142



11143



4 pc. Magnetic Containers

11144

- Dimensions: 2-1/2" diameter x 3" deep
- Magnetic twist-off lid
- Clear container for easy identification



Part #	Colors	UPC	Master	Inner
11140	Red	8-02090-11140-2	96	12
11141	White	8-02090-11141-9	96	12
11142	Black	8-02090-11142-6	96	12
11143	Chrome	8-02090-11143-3	96	12

UPC	Master	Inner
8-02090-11144-0	72	1

Rare Earth Magnetic Hook 11138

- Diameter: 1-1/2"
- Holds up to 65lbs
- Strong neodymium magnet
- Hook swivels up and down, and rotates 360 degrees



UPC	Master	Inner
8-02090-11138-9	192	12

Reversible Magnetic Hook 11139

- Diameter: 2-1/4"
- Holds up to 25lbs
- Loosen the bolt and flip the hook for versatility in hanging directions
- Use to hand lights, wiring, tools, banners, decorations and more from any ferrous metal surface



UPC	Master	Inner
8-02090-11139-6	96	12

Magnetic Hooks

- Ideal for holding keys, tools, utensils, and more



Part #	Sizes	UPC	Master	Inner
11165 2-pc 8lbs	1-7/16in	8-02090-11165-5	192	12
11166 2-pc 15lbs	2in	8-02090-11166-2	96	12

Part #	Sizes	UPC	Master	Inner
11167 15lbs	2-1/2in	8-02090-11167-9	96	12
11168 40lbs	3in	8-02090-11168-6	96	12

1/2 in. x 30 in. Flexible Magnetic Tape Roll 11197

- Dimensions: 1/2" wide x 30" long
- Can be easily cut to desired length
- Adhesive on one side, magnetic on the other



UPC	Master	Inner
8-02090-11197-6	72	12

Magnetizer-Demagnetizer 11145

- To Magnetize: insert tool in and out of the + chamber
- To Demagnetize: Insert tool in and out of the lowest step in the - chamber
- If tool is still magnetized, repeat on a higher step



UPC	Master	Inner
8-02090-11145-7	96	1

Hori Hori Gardening Tool 11094

- Great for transplanting, weeding, cultivating, grubbing, breaking tough soil, prying and many other uses
- Sharp stainless steel blade ideal for precision cutting and removal of deep roots
- Serrated edges help rid area of unwanted roots and tough weeds
- Sturdy stainless steel strong enough for chopping branches, thick roots, etc.
- Sturdy pointed tip for prying
- Grooved for digging
- Black vinyl sheath with belt holder

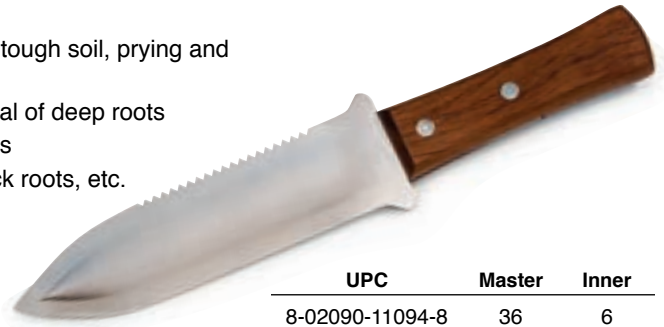

UPC	Master	Inner
8-02090-11094-8	36	6

Adjustable Water Spray Hose Nozzle 11091

- Attaches to any garden hose
- Twist action adjustable valve for variable water streams
- Durable rubber material
- Ships bulk in a 6pc counter display



UPC	Master	Inner
8-02090-11091-7	48	6

Power Spray Nozzle 11102

- Adjustable flow control
- Ergonomic lever controls water flow and minimizes hand fatigue
- Molded grip for cushioned support
- Insulated handle
- Won't rust or corrode

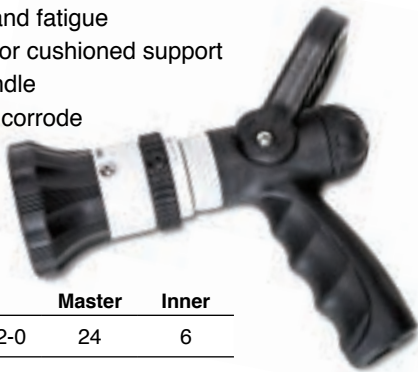

UPC	Master	Inner
8-02090-11102-0	24	6

Power Spray Nozzle 11104

- Adjustable flow control
- Smooth action lever handle for switching on & off
- Molded grip for cushioned support
- Insulated handle
- Solid zinc-and-rubber construction



UPC	Master	Inner
8-02090-11104-4	24	6

Power Spray Nozzle 11107

- Adjustable flow control
- Leak proof design
- Molded grip for cushioned support
- Insulated handle
- Brass construction to reduce corrosion



UPC	Master	Inner
8-02090-11107-5	24	6

Power Spray Hose Nozzle 11090

- Twist nozzle for 3 spray patterns: Gentle Shower, Medium Power Spray, & Heavy Duty Jet
- Durable yet soft grip comfort handles
- Stainless steel needle
- Material will not scratch or dent surfaces
- Over 40 ft of powerful jet spray
- Attaches to any garden hose



UPC	Master	Inner
8-02090-11090-0	96	6

Camo Moving Blanket 22017

- Dimensions: 72" x 80"
- Shell is made of non-woven synthetic fibers
- Filler material made of recycled denim cotton
- Oil & water resistant
- Weight: 3.5lbs

UPC	Master	Inner
8-02090-22017-3	12	6



Propane Heat Gun 51886

- For Use With Various Applications Such As: Vinyl Wrapping, Window Tinting, Heat Shrink Tubing, Paint Removal, Thawing Frozen Pipes, Bending Plastics & More
- Temperature Range: 842 ~ 1022° F (450 ~ 550° C)
- Connects To Disposable Propane Cylinders
- Hands Free Vertical Stand
- Includes Spreader Nozzle & Deflector Nozzle

UPC	Master	Inner
8-02090-51886-7	12	6



Multi-Purpose Organizer 21267

- Container dimensions: L: 4.25 W: 12.2 H: 2.5
- 4 storage compartments
- Clear plastic hinged lid for easy viewing
- Individual compartment measurements: L: 3.5 W: 2.5 H: 2.25
- Use to store small parts, hardware & other supplies



UPC	Master	Inner
8-02090-21267-3	36	1

Multi-Purpose Organizer 21268

- 9 adjustable storage compartments
- Overall Dimensions: 18.11" W X 6.69" D X 3.74" H
- Individual Compartment Dimensions: 1.81" W x 5.35" D x 2.44 H", 0.78" W x 5.35" D x 2.44" H
- Use to store small parts, hardware & other supplies



UPC	Master	Inner
8-02090-21268-0	24	1



12-Drawer Multi Purpose Organizer 21269

- Overall Dimensions: 10.40" W X 9.25" D X 6.30" H
- Includes: (8) small drawers & (4) large drawers
- Great for storing/ organizing small hardware & accessories
- Mounts to wall or stands on bench

UPC	Master	Inner
8-02090-21269-7	8	

3-Way Stackable Storage Totes

- Designed to Stack & Go
- Versatile lid fits utility box & storage tote
- Separate or combine utility box and storage tote at your convenience
- Durable handles lock top and bottom together for easy carrying
- Use to store: small parts, hardware, camping gear & other essential items
- Utility box features (2) primary compartments & (6) fully adjustable space dividing tabs



Part #	Size (in.)	Dimensions	UPC	Master	Inner
21218	18	Overall Dimensions: Utility Box: 18" W x 3.25" H x 11.5" D	8-02090-21218-5	6	1
		Storage Tote: 16" W x 5.75" H x 11.5" D			
		Stacked: 18" W x 9" H x 11.5" D			
21222	22	Overall Dimensions: Utility Box: 22" W x 3.25" H x 14.5" D	8-02090-21222-2	6	1
		Storage Tote: 20" W x 6" H x 14.5" D			
		Stacked: 22" W x 9.25" H x 14.5" D			

12 pc. Utility Box Dividers 21216

- Includes: (6) Long Dividers: 6-1/2 Inches x 2-1/5 Inches
(6) Short Dividers: 3-1/10 Inches x 2-1/5 Inches
- Customize storage in utility boxes
- Use with TITAN 21218 & 21222



UPC	Master	Inner
8-02090-21216-1	48	12

Tool Box Drawer Liner 30931

- 16" x 8"
- Non-adhesive gripping fabric
- Washable
- Easily cuts to size
- Stops sliding and rattling



UPC	Master	Inner
8-02090-30931-1	12	1

Wrench Set Pouches

- Pouch rolls up for compact storage and draw strings keep the rolled up pouch securely rolled
- Features two eyelets to allow the pouch to be hung on peg hooks, nails, or screws
- Machine washable
- Oil and moisture resistant
- Pouch dimensions are: 17-3/4" H x 21-1/4" W

98050

- 14 Slot heavy duty red fabric wrench pouch is designed for SAE wrench sizes 3/8" through 1-1/4" but can be used with other size wrenches or tools

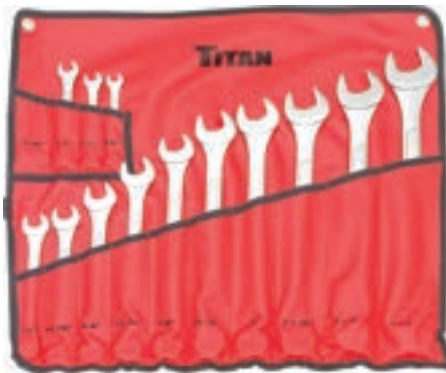

WRENCHES
NOT INCLUDED

Part #	UPC	Master	Inner
98050	RED 8-02090-98050-3	20	1

98051

- 16 Slot heavy duty blue fabric wrench pouch is designed for Metric wrench sizes 10,11,12, 13, 14, 15, 16, 17, 18, 19, 21, 22, 24, 25, 30, 32mm but can be used with other size wrenches or tools



WRENCHES
NOT INCLUDED

Part #	UPC	Master	Inner
98051	BLUE 8-02090-98051-0	20	1

Easy Carry Wrench Racks

- Sturdy plastic grippers are slightly flexible, gripping wrenches firmly, yet allowing easy placement or removal
- Large carry handle

Part #	UPC	Master	Inner
98013	SAE 8-02090-98013-8	40	10
98012	METRIC 8-02090-98012-1	10	40

98013

- Engraved with 13 SAE sizes: 1/4" - 1"



98012

- Engraved with 12 metric sizes: 8-19mm



Socket Rails

- Handle allows for easy maneuverability
- Rail can be stored in drawer or hung from pegboard, display, nail, etc.
- Chrome vanadium steel
- Mirror polish finish



Part #	Drive Size (in.)	# of slots	UPC	Master	Inner
66000	1/4	12	8-02090-66000-9	36	6
68000	3/8	14	8-02090-68000-7	36	6
62000	1/2	14	8-02090-62000-3	36	6

Magnetic Aluminum Socket Rails

- Accepts standard and deep sockets
- Anodized Aluminum rail construction
- Super strong magnet for solid placement

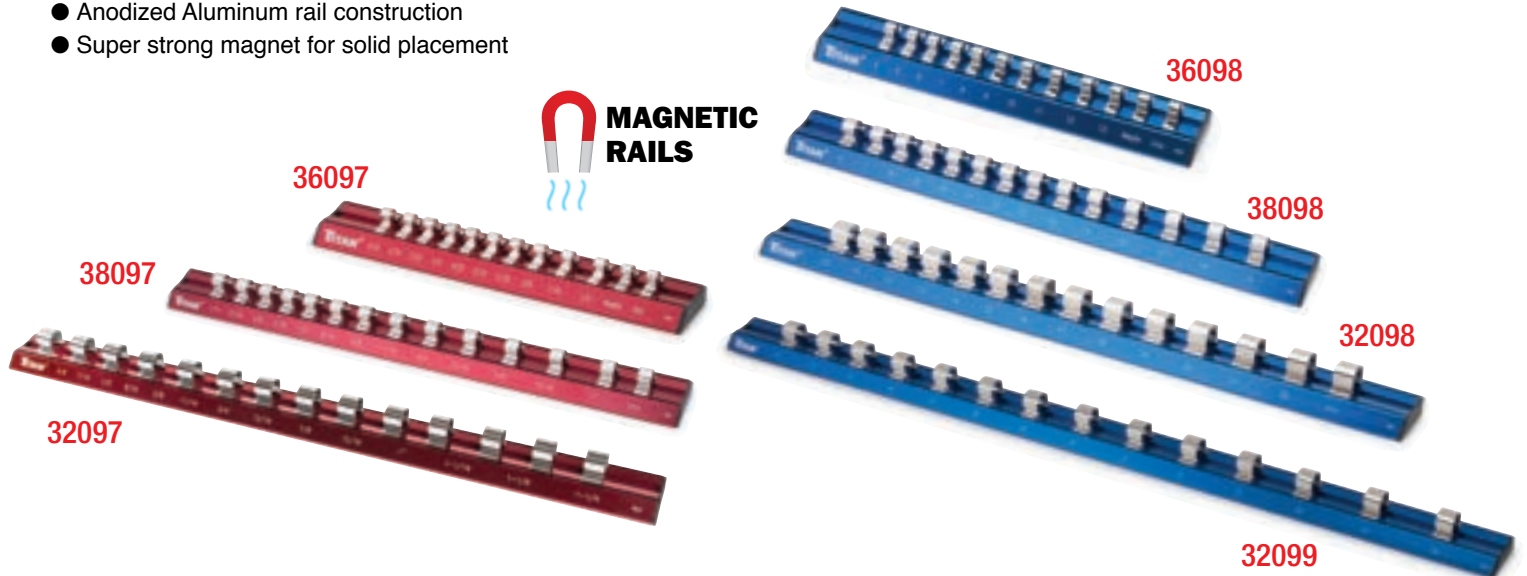

Part #	Drive Size (in.)	Color	# of Slots	Size Markings	Rail Size	UPC	Master	Inner
36097	1/4	RED	12	5/32", 3/16", 7/32", 1/4", 9/32", 5/16", 11/32", 3/8", 7/16", 1/2", Adapter & U-Joint	8" x 1-5/16"	8-02090-36097-8	96	12
38097	3/8	RED	14	1/4", 5/16", 3/8", 7/16", 1/2", 9/16", 5/8", 11/16", 3/4", 13/16", 7/8", 15/16", 1" & U-Joint	14-1/4" x 1-5/16"	8-02090-38097-6	72	12
32097	1/2	RED	14	3/8", 7/16", 1/2", 9/16", 5/8", 11/16", 3/4", 13/16", 7/8", 15/16", 1", 1-1/16", 1-1/8", & 1-1/4"	17" x 1-5/16"	8-02090-32097-2	72	12
36098	1/4	BLUE	12	4, 5, 6, 7, 8, 9, 10, 11, 12, 13, Adapter, U-Joint	8" x 1-5/16"	8-02090-36098-5	96	6
38098	3/8	BLUE	14	4, 5, 6, 7, 8, 9, 10, 11, 12, 13, 14, 15, 16, 17, 18, 19	14-1/4" x 1-5/16"	8-02090-38098-3	96	12
32098	1/2	BLUE	14	10, 11, 12, 13, 14, 15, 16, 17, 18, 19, 20, 21, 22, U-Joint	17" x 1-5/16"	8-02090-32098-9	72	12
32099	1/2	BLUE	14	23, 24, 25, 26, 27, 28, 29, 30, 31, 32, 33, 34, 35, 36	23-3/4 x 1-5/16"	8-02090-32099-6	72	12

Non-Marring Lug Nut Sockets

- Non-marring core & sleeve prevents damage to wheels & lug nuts
- Hollow core design for use on longer wheel studs
- Removable outer sleeve for thin wall applications
- Color coded for easy identification
- 1/2 in. Drive, 6 point
- Chrome moly steel construction
- Overall length: 3-3/8"

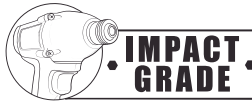

21095



21091



21092



21093



21094



Part #	Sizes	UPC	Master	Inner
21095 4-pc 1/2in Dr.	17, 19, 21 & 22mm	8-02090-21095-2	15	1
21091 1/2in Dr.	17mm	8-02090-21091-4	48	12
21092 1/2in Dr.	19mm	8-02090-21092-1	48	12
21093 1/2in Dr.	21mm	8-02090-21093-8	48	12
21094 1/2in Dr.	22mm	8-02090-21094-5	48	12

XL Non-Marring Lug Nut Sockets

- 1/2" Drive
- 6 Point
- Overall Length: 6"
- Chrome-Moly Construction
- Non-Marring core & sleeve prevents damage to lug nut & wheel
- Extra long design for use with wider wheels



21117



21119



21121



21122



Part #	Sizes	UPC	Master	Inner
21117 1/2in Dr.	17mm	8-02090-21117-1	24	6
21119 1/2in Dr.	19mm	8-02090-21119-5	24	6
21121 1/2in Dr.	21mm	8-02090-21121-8	24	6
21122 1/2in Dr.	22mm	8-02090-21122-5	24	6

SAE/Metric Lug Wrench

- Carbon Steel Construction
- Full Polish
- Sizes stamped

21080

- Net weight : 2.15 lbs.

21086

- Net weight : 6.05 lbs



Part #	Sizes	UPC	Master	Inner
21080 14 in.	7,19,21,& 23mm 11/16, 3/4,13/16, & 7/8 in.	8-02090-21080-8	12	1
21086 22 in.	22, 24, 26, 27mm 1-1/16, 1, 15/16, & 7/8 in.	8-02090-21086-0	6	1

14 in. SAE/Metric Folding Lug Wrench 21081

- Carbon steel construction
- Full Polish
- Sizes include: 17,19,21,& 23mm, 11/16, 3/4,13/16, & 7/8"
- Net weight : 2.90 lbs.

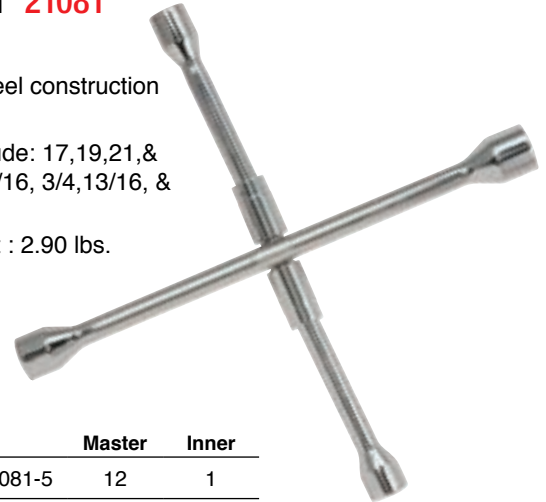

UPC	Master	Inner
8-02090-21081-5	12	1

L-Type Lug Wrench

- Carbon steel construction
- Black Finish
- Blade tip for hubcap pry-off



Part #	Sizes	UPC	Master	Inner
21083	3/4 in.	8-02090-21083-9	25	1
21084	13/16 in.	8-02090-21084-6	25	1
21085	7/8 in.	8-02090-21085-3	25	1

Professional Workbench 21006

- Durable Powder Coated Finish
- Full bottom shelf
- Weight capacity: 1,200 lbs
- Top panel: 13 gauge steel
- Bottom shelf: 13 gauge steel
- Steel support: 12 gauge steel
- Overall Dimensions: 60" W x 31" D x34" H



UPC	Master	Inner
8-02090-21006-8	1	1

4 pc. 4 in. Heavy-Duty Swivel Casters 21005

- Durable
- Load capacity: 1,200 lbs (300 lbs each)
- Wheel diameter: 4 Inch
- Wheel Width: 1-3/16 Inch
- For use with Titan part #21006 Heavy Duty Work Bench



UPC	Master	Inner
8-02090-21005-1	1	1

Part #	Description	Page #	Part #	Description	Page #	Part #	Description	Page #
209	8 in. Adjustable Construction Wrench	4	11145	Magnetizer-Demagnetizer	219	11400	9 in. Pistol Grip Pliers/Crimper	35
211	10 in. Adjustable Construction Wrench	4	11158	Telescoping Pocket Inspection Mirror	50	11401	16 in. XL Pistol Grip Needle Nose Pliers	35
215	15 in. Adjustable Wrench	3	11159	3 lb. Pocket Magnetic Retriever	51	11412	7-1/2 in. Compound Diagonal Cutters	187
216	12 in. Adjustable Construction Wrench	4	11160	Telescoping Inspection Mirror	190	11424	24 in. Cable Cutter	36
218	18 in. Adjustable Wrench	3	11161	3 lb. Telescoping Magnetic Pickup Tool	190	11436	Digital Circuit Tester	43
223	3 pc. Adjustable Construction Wrench Set	4	11162	24 in. Flexible Claw Pickup Tool	51	11448	MIG Wire Utility Pliers	176
224	24 in. Adjustable Wrench	3	11163	24 in. Flexible Magnetic Pickup Tool	51	11460	Straight Cut Aviation Snips	37
10901	25 ft. 2 pk. Tape Measure	55	11165	2 pc. 1-1/2 in. Magnetic Hooks	219	11461	Right Cut Aviation Snips	37
10902	4 pc. Tape Measure Set	55	11166	2 pc. 2 in. Magnetic Hooks	219	11462	Left Cut Aviation Snips	37
10903	2 pc. Combo Dual Rule Tape Measure Set	55	11167	2-1/2 in. Mag Hook	219	11469	Adjustable Wire Stripper	43
10904	12 ft. Tape Measure	56	11168	3 in. Magnetic Hook	219	11470	Compound Action Cable Cutters	36
10905	16 ft. Tape Measure	56	11170	170 pc. Titanium Coated Drill Bit Set	133	11471	Extra-Long Utility Snips	37
10906	25 ft. Tape Measure	56	11171	10 pc. 1/2 in. Ceramic Magnetic Discs	217	11474	Coaxial Cable Stripper	43
10907	25 ft. Dual-Rule Tape Measure	56	11172	8 pc. 3/4 in. Ceramic Magnetic Discs	217	11475	Self Adjusting Wire Stripper	43
10908	33 ft. Tape Measure	56	11173	6 pc. 1 in. Ceramic Magnetic Discs	217	11476	3 pc. Compact Electrical Tool Set	44
11003	27 pc. Micro Drill Set with Driver	133	11174	6 pc. 3/4 in. Ceramic Magnetic Discs	217	11477	Ratcheting Wire Terminal Crimper	44
11006	22 pc. Titanium Drill Bit	133	11175	2 pc. 1-3/4 in. Ceramic Magnetic Discs	217	11478	Stripping/Crimping Pliers	44
11009	Fits-All-Phillips Screwdriver	188	11176	4 pc. 12 mm Rare Magnetic Discs	218	11479	Pistol Grip Wire Stripper	44
11010	6-in-1 Screwdriver	188	11177	3 pc. 18 mm Rare Magnetic Discs	218	11483	3/8 in. Internal Pipe Wrench	59
11014	High-Torque Ratcheting Screwdriver	188	11180	10-1/2 in. Magnetic Strainer	54	11484	1/2 in. Internal Pipe Wrench	59
11015	Folding Utility Knife	68	11181	8 pc. Ceramic Magnetic Blocks	217	11485	3/4 in. Internal Pipe Wrench	59
11018	Folding Utility Knife	68	11182	2 pc. Ceramic Magnetic Blocks	217	11487	Mini Tubing Bender	59
11020	Twin Pack Folding Utility Knife	68	11183	2 pc. Ceramic Magnetic Blocks	217	11488	Tubing Bending Pliers	59
11024	Sliding Utility Knife	68	11184	2 pc. Coated Ceramic Magnetic Blocks	217	11489	180 Degree Tubing Bender	59
11026	Readi-Blade Utility Knife	68	11185	Telescoping Inspection Mirror	50	11490	1/8 in. to 7/8 in. Mini Tubing Cutter	60
11030	Multi-Purpose Razor Scraper	192	11186	Telescoping Inspection Mirror	50	11491	1/8 in. to 1-3/8 in. Tubing Cutter	60
11031	Mini Razor Scraper	192	11187	2 pc. Telescoping Tool Set	50	11492	Tubing Cutter Replacement Blade	60
11034	10 pc. Standard Utility Knife Blades	68	11188	2 pc. Utility Tool Set	50	11493	Tubing Cutter Replacement Blade	60
11036	100 pc. #9 Single Edge Razor Blades	67	11189	4-1/4 in. Round Magnetic Parts Tray	52	11498	3 pc. Internal Pipe Wrench Set	59
11038	100 pc. #12 Single Edge Razor Blades	67	11190	16 lb. Magnetic Pick Up Tool	51	11499	12 in. Basin Wrench	61
11039	21 pc. Heavy Duty Razor Blades	67	11191	3 lb. Telescoping Magnetic Pick Up Tool	51	11500	1-1/4 in. Stainless Steel Scraper	193
11050	1/4 in. and 3/8 in. Dr. Dual Head Stubby Ratchet	191	11192	5 lb. Telescoping Magnetic Pick-Up Tool	51	11503	3 in. Refinishing Tool	200
11052	1/4 in. and 3/8 in. Dr. Offset Ratchet	190	11193	2 in. Telescoping Inspection Mirror	50	11504	3 in. Offset Stainless Steel Scraper	193
11057	1/4 in. and 3/8 in. Dr. Ratchet	190	11194	Mini Magnetic Parts Tray	54	11505	5-1/2 in. Mini Pry Bar	192
11058	3/8 and 1/2 in Drive Ratchet	190	11195	Mini Magnetic Tray	53	11508	1-1/4 in. Offset Stainless Steel Scraper	193
11060	8 in. Stubby Adjustable Wrench	187	11196	5-7/8 in. x 2-1/2 in. Mini Rectangular Magnetic Parts Tray	53	11509	9-1/4 in. Multi-Purpose Pry Bar	192
11061	Mini Magnetic Parts Tray	189	11197	1/2 in. x 30 in. Flexible Magnetic Tape Roll	219	11510	6-in-1 Painters Tool and Scraper	193
11064	3-in-1 Lighted Retriever	51	11199	Coated Ceramic Magnetic Block	186	11511	12 in. Multi-Purpose Pry Bar	196
11065	3 pc. Utility Tool Set	50	11200	1/4 in. Dr. Gearless Micro Ratchet	80	11513	Multi-Purpose Pry Bar	63
11066	1/4 in. Dr. Swivel Head Ratchet	81	11201	3/8 in. Dr. Gearless Micro Ratchet	86	11565	4 pc. Nylon Scraper Set	62
11067	3/8 in. Dr. Swivel Head Ratchet	83	11202	2 pc. Micro Bit Driver and Ratchet Set	75	11566	6 pc. Panel Removal Set	200
11074	1/4 in. Dr. Flex-Head Extra-Long Ratchet	106	11203	2 pc. Offset Micro Bit Driver and Ratchet Set	75	11663	Telescoping Magnetic Pickup Tool	188
11076	3/8 in. Dr. Swivel Head Ratchet	83	11204	1/4 in. Dr. Offset Micro Ratchet	80	11666	Rectangular Inspection Mirror	50
11082	1/2 in. Dr. Ratchet Rebuild Kit	106	11205	Offset Micro Bit Driver With Bits	80	11716	16 lb. Magnetic Pick Up Tool	188
11083	3/8 in. Dr. Ratchet Rebuild Kit	106	11206	1/4 in. Dr. Offset Micro Ratchet	191	11763	3 lb. Telescoping Magnetic Pickup Tool	188
11085	1/4 in. Dr. Extra-Long Ratchet	106	11207	Offset Micro Bit Driver	191	11900	Ratcheting Crimper Frame (empty)	46
11090	Power Spray Hose Nozzle	220	11212	10 pc. Micro Flex Bit Ratchet Set	80	11901	A Die Insulated Terminals	47
11091	Adjustable Water Spray Hose Nozzle	220	11214	3 pc. Damaged Screw Removal Set	194	11902	A1 Die Heat Shrink Butt Connectors	47
11094	Hori Hori Gardening Tool	220	11215	3 pc. Damaged Screw Extractor Set	132	11903	A2 Die Fully Insulated Quick Disconnect	47
11102	Power Spray Nozzle	220	11218	3 pc. 1/4 in. Dr. Finger Grip Drivers	26	11904	A3 Die Mini Insulated Terminals	47
11104	Power Spray Nozzle	220	11300	1/4 in. Dr. 12 in. Extra-Long Flex-Head Ratchet	79	11905	A4 Die Insulated Flag Terminals	47
11107	Power Spray Nozzle	220	11301	3/8 in. Dr. 18 in. Extra-Long Flex-Head Ratchet	83	11906	A5 Die Closed End Connector and Heat Shrink	47
11110	Folding Knife with Locking Wrench	49	11302	1/2 in. Dr. 24 in. Extra-Long Flex-Head Ratchet	97	11915	H1 Spark Plug Connector	47
11124	25 ft. Tape Measure	56	11303	3 pc. Extra-Long Flex-Head Ratchet Set	74	11946	H6 Die Delphi Weather Pack Terminal	47
11132	10 pc. 9.5mm Rare Magnetic Discs	218	11304	1/4 in. Dr. 12 in. Extra-Long Ratchet	79	11947	H7 Die Delphi Weather Pack Terminal	47
11134	10 pc. 8mm Rare Magnetic Discs	218	11305	3/8 in. Dr. 18 in. Extra-Long Ratchet	83	11950	7 pc. Ratcheting Terminal Crimping Set	46
11135	12 pc. 9.5mm Rare Magnetic Discs	218	11306	1/2 in. Dr. 24 in. Extra-Long Ratchet	97	11955	Ratcheting Heat Shrink Terminal Crimper	45
11136	40 pc. Ceramic Magnetic Discs	217	11307	3 pc. Extra-Long Ratchet Set	74	11956	Ratcheting Spark Plug Connector Crimper	45
11137	2 pc. Multi-Pole Magnetic Discs	217	11308	1/4 in. Dr. 36-Tooth Ratchet Rebuild Kit	106	11961	K1 Die Deutsch Terminal	48
11138	Rare Earth Magnetic Hook	219	11309	3/8 in. Dr. 36-Tooth Ratchet Rebuild Kit	106	11962	K2 Die Deutsch Terminal	48
11139	Reversible Magnetic Hook	219	11310	1/2 in. Dr. 36-Tooth Ratchet Rebuild Kit	106	11963	K3 Die Deutsch Terminal	48
11140	2 pc. Red Magnetic Clips	218	11350	1/4 and 3/8 in. Dr. Flex Head Stubby Ratchet	191	11964	K4 Die Deutsch Terminal	48
11141	2 pc. White Magnetic Clips	218				11965	K5 Die Deutsch Terminal	48
11142	2 pc. Black Magnetic Clips	218				11966	K6 Die Deutsch Terminal	48
11143	2 pc. Magnetic Clips	218				12015	3/8 in. Dr. 15 in. Ratcheting Breaker Bar	87
11144	4 pc. Magnetic Containers	218				12018	1/2 in. Dr. 18 in. Ratcheting Breaker Bar	96

Part #	Description	Page #	Part #	Description	Page #	Part #	Description	Page #
12019	3/8 in. Dr. 18 in. Breaker Bar	87	12175	5 pc. 90 Tooth Ratchet Set	73	12613	1 in. 12 pt. Rat. Comb. Wrench	13
12021	1/2 in. Dr. Replacement Breaker Bar Head	96	12212	12 in. Indexable Pry Bar	41	12614	1-1/16 in. 12 pt. Rat. Comb. Wrench	13
12022	3/4 in. Dr. Replacement Breaker Bar Head	105	12215	15 in. Indexable Pry Bar	41	12615	1-1/8 in. 12 pt. Rat. Comb. Wrench	13
12023	1 in. Dr. Replacement Breaker Bar Head	106	12216	3 pc. Indexable Pry Bar Set	41	12616	1-1/4 in. 12 pt. Rat. Comb. Wrench	13
12024	1/2 in. Dr. 24 in. Ratcheting Breaker Bar	96	12217	12 pc. 10 in. High-Torque Flex-Head Ratcheting Screwdriver	26	12624	4 pc. Socket and Bit Driver Conversion Kit	16
12025	1-1/4 in. Flexible Scraper	64	12218	12 pc. 18 in. Extra-Long Ratcheting Screwdriver	26	12700	10 pc. SAE Folding Ball End Hex Key Set	20
12027	3/8 in. Dr. Replacement Breaker Bar Head	106	12220	12 pc. 12in. High-Torque Ratcheting Screwdriver	26	12703	9 pc. SAE Folding Hex Key Set	20
12028	1/2 in. Dr. Replacement Breaker Bar Head	106	12225	Fits All Phillips Screwdriver	27	12705	9 pc. Folding Metric Ball End Hex Key Set	20
12029	3-Position Scraper	67	12227	9 pc. Flexible Driver and Bit Set	27	12708	7 pc. Metric Folding Hex Key Set	20
12030	Multi-Purpose Razor Scraper	66	12229	Flexible Hose Clamp Driver	182	12710	10 pc. Tamp. Resist. Folding Star Key Set	20
12031	Mini Razor Scraper	66	12240	Quarter Turn Fastener Tool	30	12712	25 pc. Hex Key Set	21
12034	3/8 in. Square Drive to 1/4 in. Hex Drive Quick Change Imp. Adapter	144	12308	8 in. Multi-Purpose Utility Shears	37	12713	13 pc. Extra Long SAE Non Slip Hex Key Set	18
12036	3 pc. Reducing Imp. Adapter Set	128	12345	7-1/2 in. Multi-Purpose Shears	37	12714	9 pc. Extra Long Metric Non Slip Hex Key Set	18
12038	21 pc. Non-Marring Scraper Blades	67	12346	5-1/2 in. Multi-Purpose Electrical Shears	37	12715	13 pc. Extra Long Tamp. Resist. Star Key Set	18
12039	Quick Change Imp. Adapter	144	12350	1/4 in. and 3/8 in. Dr. Flex Head Stubby Ratchet	85	12718	13 pc. SAE Long Arm Hex Key Set	21
12042	1/4 in. Dr. Offset Ratchet	79	12351	3/8 in. and 1/2 in. Dr. Flex-Head Ratchet	98	12719	9 pc. Metric Long Arm Hex Key Set	21
12043	3/8 in. Dr. Offset Ratchet	85	12357	1/4 in. and 3/8 in. Dr. Flex-Head Ratchet	86	12726	16 pc. SAE/Metric Hex Key Set	21
12044	1/2 in. Dr. Offset Ratchet	98	12358	3/8 in. and 1/2 in. Dr. Flex Ratchet	86	12727	7 pc. SAE Short Arm Hex Key Set	21
12045	3/8 in. Dr. Offset Extra-Long Ratchet	85	12441	7 in. Metal Shears	38	12733	8 pc. Triple Square Key Set	18
12046	1/2 in. Dr. Offset Extra-Long Ratchet	97	12442	9 in. Mesh Shears	38	12734	10 pc. Tamp. Resist. 5-Lobe Key Set	18
12047	1/2 in. Dr. 30 in. Breaker Bar	96	12443	10 in. Metal Shears	38	12735	9 pc. Ball End SAE Hex Key Set	19
12048	3/4 in. Dr. x 40 in. Breaker Bar	105	12444	10 in. Offset Metal Shears	38	12736	9 pc. Ball End Metric Hex Key Set	19
12049	1 in. Dr. x 40 in. Breaker Bar	105	12462	1 in. Carbon Scraper	62	12737	13 pc. SAE Low Profile Hex Key Set	19
12050	1/4 in. and 3/8in Drive Stubby Ratchet	85	12500	1-1/4 in. Stainless Steel Scraper	64	12738	9 pc. MM Low Profile hex Key Set	19
12051	3/8 in. and 1/2 in. Dr. Stubby Ratchet	98	12501	1-1/4 in. Flexible Scraper	64	12739	39 pc. Star and Hex Key Set	21
12052	1/4 in. and 3/8 in. Dr. Offset Ratchet	85	12503	3 in. Flexible Scraper	64	12756	12 pc. SAE Hex Extractor and Hex Key Set	19
12053	3/8 in. and 1/2 in. Dr. Offset Ratchet	98	12505	1-1/4 in. Offset Stainless Steel Scraper	65	12757	9 pc. Metric Hex Extractor and Hex Key Set	19
12057	3/8 in. Dr. Extendable Ratchet	83	12506	6 mm 12 pt. Rat. Comb. Wrench	13	12768	8 pc. SAE T-Handle Hex Key Set	18
12071	1/4 in. and 3/8 in. Dual Drive Stubby Extendable Ratchet	191	12507	7 mm 12 pt. Rat. Comb. Wrench	13	12769	6 pc. Metric T-Handle Hex Key Set	18
12072	3/4 in. Dr. Extendable Ratchet	105	12508	8 mm 12 pt. Rat. Comb. Wrench	13	12770	8 pc. Locking SAE Hex Key Set	20
12073	1/2 in. Dr. Extendable Ratchet	99	12509	9 mm 12 pt. Rat. Comb. Wrench	13	12771	8 pc. Locking Metric Hex Key Set	20
12074	1/2 in. Dr. Extendable Ratchet	99	12510	10 mm 12 pt. Rat. Comb. Wrench	13	12772	8 pc. Locking Star Key Set	20
12075	1/4 in. Dr. Extendable Ratchet	79	12511	11 mm 12 pt. Rat. Comb. Wrench	13	12808	8 mm 12 pt. Flex-Head Rat. Comb. Wrench	14
12079	3 pc. 3/8 in. Dr. Extra-Long Ext. Set	88	12512	12 mm 12 pt. Rat. Comb. Wrench	13	12809	9 mm 12 pt. Flex-Head Rat. Comb. Wrench	14
12081	3 pc. 1/2 in. Dr. Extra-Long Ext. Set	95	12513	13 mm 12 pt. Rat. Comb. Wrench	13	12810	10 mm 12 pt. Flex-Head Rat. Comb. Wrench	14
12082	3 pc. Socket Adapter Set	142	12514	14 mm 12 pt. Rat. Comb. Wrench	13	12811	11 mm 12 pt. Flex-Head Rat. Comb. Wrench	14
12086	3pc 6 in. Long Socket Adapter Set	142	12515	15 mm 12 pt. Rat. Comb. Wrench	13	12812	12 mm 12 pt. Flex-Head Rat. Comb. Wrench	14
12087	6 pc. Socket Adapter Set	142	12516	16 mm 12 pt. Rat. Comb. Wrench	13	12813	13 mm 12 pt. Flex-Head Rat. Comb. Wrench	14
12089	9 pc. Imp. Skt. Adapter Set	142	12517	17 mm 12 pt. Rat. Comb. Wrench	13	12814	14 mm 12 pt. Flex-Head Rat. Comb. Wrench	14
12090	1/4 in. Dr. Finger Ratchet	80	12518	18 mm 12 pt. Rat. Comb. Wrench	13	12815	15 mm 12 pt. Flex-Head Rat. Comb. Wrench	14
12091	3/8 in. Dr. Finger Ratchet	86	12519	19 mm 12 pt. Rat. Comb. Wrench	13	12816	16 mm 12 pt. Flex Head Rat. Comb. Wrench	14
12092	1/2 in. Dr. Finger Ratchet	98	12520	20 mm 12 pt. Rat. Comb. Wrench	13	12817	17 mm 12 pt. Flex-Head Rat. Comb. Wrench	14
12098	4 pc. 2-Way Ext. Set	76	12521	21 mm 12 pt. Rat. Comb. Wrench	13	12818	18 mm 12 pt. Flex-Head Rat. Comb. Wrench	14
12101	1/4 in. Dr. 3 in. Mini Ratchet	80	12522	22 mm 12 pt. Rat. Comb. Wrench	13	12819	19 mm 12 pt. Flex-Head Rat. Comb. Wrench	14
12102	3/8 in. Dr. 3 in. Mini Ratchet	86	12524	23 mm 12 pt. Rat. Comb. Wrench	13	12901	1/4 in. 12 pt. Flex-Head Rat. Comb. Wrench	14
12103	1/4 in. and 3/8in Drive Mini Ratchet	75	12525	24 mm 12 pt. Rat. Comb. Wrench	13	12902	5/16 in. 12 pt. Flex-Head Rat. Comb. Wrench	14
12135	Multi-Function Tool	49	12526	27 mm 12 pt. Rat. Comb. Wrench	13	12903	3/8 in. 12 pt. Flex-Head Rat. Comb. Wrench	14
12136	Multi-Function Tool	49	12527	30 mm 12 pt. Rat. Comb. Wrench	13	12904	7/16 in. 12 pt. Flex-Head Rat. Comb. Wrench	14
12141	4 in. Adjustable Wrench	3	12528	32 mm 12 pt. Rat. Comb. Wrench	13	12905	1/2 in. 12 pt. Flex-Head Rat. Comb. Wrench	14
12142	6 in. Adjustable Wrench	3	12529	34 mm 12 pt. Rat. Comb. Wrench	13	12906	9/16 in. 12 pt. Flex-Head Rat. Comb. Wrench	14
12143	8 in. Adjustable Wrench	3	12600	Multi-Purpose Scraper	65	12907	5/8 in. 12 pt. Flex-Head Rat. Comb. Wrench	14
12144	10 in. Adjustable Wrench	3	12601	1/4 in. 12 pt. Rat. Comb. Wrench	13	12908	11/16 in. 12 pt. Flex-Head Rat. Comb. Wrench	14
12145	12 in. Adjustable Wrench	3	12602	5/16 in. 12 pt. Rat. Comb. Wrench	13	12909	3/4 in. 12 pt. Flex Head Rat. Comb. Wrench	14
12160	1/4 in. Dr. 6 in. Ratchet	78	12603	3/8 in. 12 pt. Rat. Comb. Wrench	13	12910	13/16 in. 12 pt. Flex-Head Rat. Comb. Wrench	14
12161	3/8 in. Dr. 12 in. Ratchet	84	12604	7/16 in. 12 pt. Rat. Comb. Wrench	13	12911	7/8 in. 12 pt. Flex-Head Rat. Comb. Wrench	14
12162	1/2 in. Dr. 16 in. Ratchet	97	12605	1/2 in. 12 pt. Rat. Comb. Wrench	13	12912	15/16 in. 12 pt. Flex-Head Rat. Comb. Wrench	14
12167	1/4 in. Dr. 6-1/2 in. Swivel Head Ratchet	78	12606	9/16 in. 12 pt. Rat. Comb. Wrench	13	12914	1 in. 12 pt. Flex-Head Rat. Comb. Wrench	14
12168	3/8 in. Dr. 10 in. Swivel Head Ratchet	84	12607	5/8 in. 12 pt. Rat. Comb. Wrench	13	13520	8 x 9 mm 12 pt. Double Box-End Ratcheting Wrench	16
12169	1/4 in. Dr. Ratchet Rebuild Kit	106	12608	11/16 in. 12 pt. Rat. Comb. Wrench	13	13521	10 x 11 mm 12 pt. Double Box-End Ratcheting Wrench	16
12170	3/8 in. Dr. Ratchet Rebuild Kit	106	12609	3/4 in. 12 pt. Rat. Comb. Wrench	13	13522	12 x 13 mm 12 pt. Double Box-End Ratcheting Wrench	16
12171	1/2 in. Dr. Ratchet Rebuild Kit	106	12610	13/16 in. 12 pt. Rat. Comb. Wrench	13	13523	14 x 15 mm 12 pt. Double Box-End Ratcheting Wrench	16
12172	1/4 in. Dr. Swivel Ratchet Rebuild Kit	106	12611	7/8 in. 12 pt. Rat. Comb. Wrench	13			
12173	3/8 in. Dr. Swivel Ratchet Rebuild Kit	106	12612	15/16 in. 12 pt. Rat. Comb. Wrench	13			
12174	1/2 in. Dr. Extendable Ratchet Rebuild Kit	106						

Part #	Description	Page #	Part #	Description	Page #	Part #	Description	Page #
13524	16 x 18 mm 12 pt. Double Box-End Ratcheting Wrench	16	15084	7 pc. Autobody Hammer Set	201	15622	22 mm 1/2 in. Dr. Hex Bit Socket	107
13525	17 x 19 mm 12 pt. Double Box-End Ratcheting Wrench	16	15085	Heel Dolly	202	15650	5/64 in. 1/4 in. Dr. Hex Bit Socket	107
13526	5/16 in. x 3/8 in. 12 pt. Double Box-End Ratcheting Wrench	16	15086	Wedge Dolly	202	15651	3/32 in. 1/4 in. Dr. Hex Bit Socket	107
13527	7/16 in. x 1/2 in. 12 pt. Double Box-End Ratcheting Wrench	16	15087	General Purpose Dolly	202	15652	7/64 in. 1/4 in. Dr. Hex Bit Socket	107
13528	9/16 in. x 5/8 in. 12 pt. Double Box-End Ratcheting Wrench	16	15088	Body Filler Shaper File Blade	204	15653	1/8 in. 1/4 in. Dr. Hex Bit Socket	107
13529	11/16 in. x 3/4 in. 12 pt. Double Box-End Ratcheting Wrench	16	15089	20 pc. 4 in. Plastic Spreaders	199	15654	9/64 in. 1/4 in. Dr. Hex Bit Socket	107
14508	8 mm 12 pt. Reversible Rat. Comb. Wrench	15	15090	Heavy Duty Suction Cup	199	15655	5/32 in. 1/4 in. Dr. Hex Bit Socket	107
14509	9 mm 12 pt. Reversible Rat. Comb. Wrench	15	15092	Multi-Grade Steel Wool	205	15656	3/16 in. 3/8 in. Dr. Hex Bit Socket	107
14510	10 mm 12 pt. Reversible Rat. Comb. Wrench	15	15093	Hose and Cotter Pin Remover	57	15657	7/32 in. 3/8 in. Dr. Hex Bit Socket	107
14511	11 mm 12 pt. Reversible Rat. Comb. Wrench	15	15200	Precision Oiler	184	15658	1/4 in. 3/8 in. Dr. Hex Bit Socket	107
14512	12 mm 12 pt. Reversible Rat. Comb. Wrench	15	15202	8 pc. 3/8 in. Dr. Metric Spline Set	94	15659	5/16 in. 3/8 in. Dr. Hex Bit Socket	107
14513	13 mm 12 pt. Reversible Rat. Comb. Wrench	15	15203	8 pc. 3/8 in. Dr. SAE Spline Set	94	15660	3/8 in. 3/8 in. Dr. Hex Bit Socket	107
14514	14 mm 12 pt. Reversible Rat. Comb. Wrench	15	15206	3 pc. 12 in. Imp. Adapter Set	142	15661	7/16 in. 1/2 in. Dr. Hex Bit Socket	107
14515	15 mm 12 pt. Reversible Rat. Comb. Wrench	15	15210	3 pc. 3 in. Locking Socket Adapter Set	144	15662	1/2 in. 1/2 in. Dr. Hex Bit Socket	107
14516	16 mm 12 pt. Reversible Rat. Comb. Wrench	15	15211	1/4 in. Dr. 3 in. Locking Socket Adapter	144	15663	9/16 in. 1/2 in. Dr. Hex Bit Socket	107
14517	17 mm 12 pt. Reversible Rat. Comb. Wrench	15	15212	3/8 in. Dr. 3 in. Locking Socket Adapter	144	15664	5/8 in. 1/2 in. Dr. Hex Bit Socket	107
14518	18 mm 12 pt. Reversible Rat. Comb. Wrench	15	15213	1/2 in. Dr. 3 in. Locking Socket Adapter	144	15665	11/16 in. 1/2 in. Dr. Hex Bit Socket	107
14519	19 mm 12 pt. Reversible Rat. Comb. Wrench	15	15214	3 pc. 6 in. Locking Socket Adapter Set	144	15666	3/4 in. 1/2 in. Dr. Hex Bit Socket	107
14601	1/4 in. 12 pt. Reversible Rat. Comb. Wrench	15	15215	1/4 in. Dr. x 6 in. Locking Socket Adapter	144	15667	13/16 in. 1/2 in. Dr. Hex Bit Socket	107
14602	5/16 in. 12 pt. Reversible Rat. Comb. Wrench	15	15216	3/8 in. Dr. x 6 in. Locking Socket Adapter	144	15668	7/8 in. 1/2 in. Dr. Hex Bit Socket	107
14603	3/8 in. 12 pt. Reversible Rat. Comb. Wrench	15	15217	1/2 in. Dr. x 6 in. Locking Socket Adapter	144	15669	15/16 in. 1/2 in. Dr. Hex Bit Socket	107
14604	7/16 in. 12 pt. Reversible Rat. Comb. Wrench	15	15218	12-in-1 Multi-Function Tool	-	15670	1 in. 1/2 in. Dr. Hex Bit Socket	107
14605	1/2 in. 12 pt. Reversible Rat. Comb. Wrench	15	15220	5 pc. SAE Nut Driver Set	141	16002	1/4 in. Hex Shank 3 in. Magnetic Bit Holder	142
14606	9/16 in. 12 pt. Reversible Rat. Comb. Wrench	15	15221	5 pc. Metric Nut Driver Set	141	16004	Flexible Ext. Bit Holder	134
14607	5/8 in. 12 pt. Reversible Rat. Comb. Wrench	15	15222	6 pc. SAE Nut Driver Set	141	16005	1/4 in. Hex Shank 6 in. Magnetic Bit Holder	142
14608	11/16 in. 12 pt. Reversible Rat. Comb. Wrench	15	15223	6 pc. Metric Nut Driver Set	141	16006	6 in. Quick-Release Ext. Bit Holder	134, 194
14609	3/4 in. 12 pt. Reversible Rat. Comb. Wrench	15	15230	30 mm 1/2 in. Dr. 12 pt. Axle Nut Socket	181	16007	1/4 in. Dr. Imp. Driver	27
14610	13/16 in. 12 pt. Reversible Rat. Comb. Wrench	15	15232	32 mm 1/2 in. Dr. 12 pt. Axle Nut Socket	181	16008	8 pc. Magnetic Bit Holder With Bits	136
14611	7/8 in. Reversible Rat. Comb. Wrench	15	15234	34 mm 1/2 in. Dr. 12 pt. Axle Nut Socket	181	16012	12 in. Quick-Release Ext. Bit Holder	134
14612	15/16 in. 12 pt. Reversible Rat. Comb. Wrench	15	15236	36 mm 1/2 in. Dr. 12 pt. Axle Nut Socket	181	16013	10 pc. Screw Extractor/Left Hand Drill Bit	132
14613	1 in. 12 pt. Reversible Rat. Comb. Wrench	15	15239	39 mm 1/2 in. Dr. 12 pt. Axle Nut Socket	181	16018	18 in. Quick-Release Ext. Bit Holder	134
14614	7/16 in. Coaxial Nut Combination Speed Wrench	43	15240	6 pc. 6 in. SAE Imp. Nut Driver Set	141	16020	2-1/4 in. Quick-Release Magnetic Bit Holder	134
15028	4.4x Magnifying Glass with LED Light	52	15241	6 pc. 6 in. Metric Imp. Nut Driver Set	141	16021	Magnetic Bit Holder Display	137
15029	2.2x Magnifying Glass with LED Light	189	15248	28 mm 1/2 in. Dr. 6 pt. Axle Nut Socket	181	16023	3/8 in. Stud Extractor	59
15036	2.2x Magnifying Glass	52	15329	29 mm 1/2 in. Dr. 6 pt. Axle Nut Socket	181	16028	26 pc. Precision Bit and Driver Set	28
15038	2.2x Magnifying Glass	189	15330	30 mm 1/2 in. Dr. 6 pt. Axle Nut Socket	181	16030	9 pc. Tamp. Resist. Torx® Bit Set	28
15040	Door Spring Tool	184	15331	31 mm 1/2 in. Dr. 6 pt. Axle Nut Socket	181	16036	13 pc. Imp. Torx® Plus Bit Set	139
15041	Door Panel Removal Tool	184	15332	32 mm 1/2 in. Dr. 6 pt. Axle Nut Socket	181	16037	13 pc. SAE Imp. Hex Bit Set	139
15045	Scratch Awl	30	15333	33 mm 1/2 in. Dr. 6 pt. Axle Nut Socket	181	16038	13 pc. Metric Imp. Hex Bit Set	139
15047	3 pc. Multi Wedge Pry Tool Set	200	15334	34 mm 1/2 in. Dr. 6 pt. Axle Nut Socket	181	16039	13 pc. Tamp. Resist. Imp. Star Bit Set	139
15048	6 pc. Multi Wedge Pry Tool Set	200	15335	35 mm 1/2 in. Dr. 6 pt. Axle Nut Socket	181	16044	45 pc. Bit Kit	134
15050	Heavy Duty Hand Riveter	49	15336	36 mm 1/2 in. Dr. 6 pt. Axle Nut Socket	181	16061	61 pc. Bit Set	194
15052	10 in. Hand Riveter with Rivets	49	15338	38 mm 1/2 in. Dr. 6 pt. Axle Nut Socket	181	16068	31 pc. Multi-Bit Screwdriver Set	27
15062	Single Flare Tool	61	15345	5 pc. 1/2 in. Dr. 1 2pt Axle Nut Socket Set	181	16073	33 pc. Imp. Bit Set	138
15063	Ratcheting PVC Pipe Cutter	61	15600	2.5 mm 1/4 in. Dr. Hex Bit Socket	107	16074	2 pc. 6 in. PH2 Imp. Bit Set	138
15064	Plumbers Brush	61	15601	5.5 mm 1/4 in. Dr. Hex Bit Socket	107	16075	5 pc. 2 in. PH2 Imp. Bit Set	138
15067	Replacement Blade for 15063	61	15602	2 mm 1/4 in. Dr. Hex Bit Socket	107	16083	3 pc. Tamp. Resist. XZN Triple Square Bit Socket Set	115
15068	7 pc. Mini Precision Trim Tool Set	201	15603	3 mm 1/4 in. Dr. Hex Bit Socket	107	16092	26 pc. Ratcheting Precision Screwdriver	28
15070	Safety Goggles	200	15604	4 mm 1/4 in. Dr. Hex Bit Socket	107	16100	100 pc. Security Bit Set	135
15071	Dent Puller Suction Cup	199	15605	5 mm 1/4 in. Dr. Hex Bit Socket	107	16103	3 pc. 1/4 in. Shank Magnetic Nut Setter	137
15072	10 in. Shaper File Blade	204	15606	6 mm 3/8 in. Dr. Hex Bit Socket	107	16104	4 pc. Socket Adapter Set	76
15073	3 pk. Spreader	199	15607	7 mm 3/8 in. Dr. Hex Bit Socket	107	16105	3 pc. Wobble Ext. Set	76
15074	Filler Scoop	199	15608	8 mm 3/8 in. Dr. Hex Bit Socket	107	16106	3 pc. 6 in. 1/4 in. Shank Magnetic Nut Setter	137
15075	10 in. 3-Position File Holder	203	15609	9 mm 3/8 in. Dr. Hex Bit Socket	107	16111	13 pc. SAE Hex Bit Set	109
15077	Regular Dent Puller	199	15610	10 mm 3/8 in. Dr. Hex Bit Socket	107	16112	13 pc. Metric Hex Bit Set	109
15078	Flexible Sander	203	15611	11 mm 1/2 in. Dr. Hex Bit Socket	107	16113	13 pc. Tamp. Resist. Star Bit Set	114
15079	Straight Finishing Hammer	202	15612	12 mm 1/2 in. Dr. Hex Bit Socket	107	16116	6 pc. Star Bit Socket Set	112
15080	Shrinking Hammer	202	15613	13 mm 1/2 in. Dr. Hex Bit Socket	107	16121	12 pc. Tamp. Resist. Star Bit Socket Set	114
15081	Pick Finishing Hammer	202	15614	14 mm 1/2 in. Dr. Hex Bit Socket	107	16122	13 pc. Torx Bit Socket Set	112
15082	8 oz. Rubber Hammer	202	15615	15 mm 1/2 in. Dr. Hex Bit Socket	107	16123	13 pc. SAE Hex Bit Socket Set	110
			15616	16 mm 1/2 in. Dr. Hex Bit Socket	107	16124	13 pc. Metric Hex Bit Socket Set	114
			15617	17 mm 1/2 in. Dr. Hex Bit Socket	107	16130	6 pc. SAE Large Hex Bit Socket Set	109
			15618	18 mm 1/2 in. Dr. Hex Bit Socket	107	16131	7 pc. Metric Large Hex Bit Socket Set	109
			15619	19 mm 1/2 in. Dr. Hex Bit Socket	107	16132	8 pc. SAE/Metric Large Hex Bit Socket Set	111
			15620	20 mm 1/2 in. Dr. Hex Bit Socket	107	16135	13 pc. Tamp. Resist. SAE Hex Bit Socket Set	115
			15621	21 mm 1/2 in. Dr. Hex Bit Socket	107			

Part #	Description	Page #	Part #	Description	Page #	Part #	Description	Page #
16136	13 pc. Tamp. Resist. Metric Hex Bit Socket Set	115	17101	4 pc. Pry Bar Set	42	17398	22 pc. 12 pt. Fully Polished SAE and Metric Comb. Wr. Set	8
16137	13 pc. Tamp. Resist. 5-Lobe Star Bit Socket Set	114	17102	4 pc. Pry Bar Set	42	17400	21 pc. Exo-Drive Socket Set	25
16138	9 pc. Stubby Triple Square Bit Socket	115	17108	Chisel Tip Wrecking Knife	201	17403	13 pc. E-Star Socket Set	114
16139	9 pc. External Star Socket Set	113	17109	All-Purpose Wrecking Knife	201	17407	7 pc. Adapter and U-Joint Set	77
16140	9 pc. Stubby SAE Hex Bit Socket Set	110	17201	9 pc. SAE Precision Pocket Screwdriver	28	17408	7 pc. Adapter and U-Joint Set	77
16141	9 pc. Stubby Metric Hex Bit Socket Set	110	17202	9 pc. Star Precision Pocket Screwdriver	28	17504	4 pc. Tape Measure Set	55
16142	10 pc. Stubby Star Bit Socket Set	112	17203	26 pc. Screwdriver Set	29	17612	12 pc. Pick Set	58
16143	10 pc. Tamp. Resist. Stubby Star Bit Socket Set	115	17208	8 pc. Screwdriver Set	29	17702	O-Ring and Hook Scribe Set	58
16144	9 pc. Triple Square Socket Set	115	17209	7 pc. Tamp. Resist. Torx® Screwdriver Set	30	17710	4 pc. Pick and Hook Set	58
16148	148 pc. Master Security Bit Set	135	17210	6 pc. Security Star Driver Set	30	17712	4 pc. Mini Pick and Hook Set	58
16150	5 pc. Pin-Free Locking U-Joint Adapter Set	129	17212	3 pc. Extra-Long Screwdriver Set	29	17808	8 in. Indexable Pry Bar	41
16151	3 pc. Pin-Free Locking Imp. U-Joint Set	129	17213	3pc Square Driver Set	30	17812	12 in. Indexable Pry Bar	41
16156	6 pc. SAE Large Hex Bit Socket Set	110	17221	4 pc. Long Pick Set	57	17816	16 in. Indexable Pry Bar	41
16157	7 pc. Metric Large Hex Bit Socket Set	110	17222	4 pc. Pick and Hook Set	57	17824	24 in. Indexable Pry Bar	41
16160	17 pc. External Torx® Socket & Bit Set	113	17223	4 pc. Jumbo Pick and Hook Set	57	17833	33 in. Indexable Pry Bar	41
16162	3 pc. SAE Hex Bit Socket Set	111	17224	4 pc. Jumbo Bolstered Pick and Hook Set	58	18025	3 pc. Quick-Release Offset Ratchet Set	73
16163	3 pc. Metric Jumbo Bit Socket Set	109	17237	7 pc. Electrician Screwdriver Set	31	18179	10 pc. Accessory Set	76
16169	10 pc. 3/8 in. Dr. SAE Hex Bit Set	111	17241	10 pc. Screwdriver Set	29	18180	21 pc. 1/4 in. Dr. SAE/Metric Socket Set	25
16170	10 pc. 3/8 in. Dr. Metric Hex Bit Socket Set	109	17242	42 pc. Screwdriver Set	31	18181	19 pc. 3/8 in. Dr. SAE/Metric Socket Set	25
16171	9 pc. 3/8 in. Dr. Star Bit Socket Set	113	17288	10 pc. 12 pt. Jumbo SAE Comb. Wr. Set	10	18182	17 pc. 1/2 in. Dr. SAE/Metric Socket Set	25
16178	2.5 in. PH2 Double End Torsion Bit	137	17289	7 pc. 12 pt. Metric Jumbo Comb. Wr. Set	10	18194	75 pc. Socket Set	24
16179	2.5 in. S2 Double End Torsion Bit	137	17290	6 pc. 12 pt. SAE Jumbo Comb. Wr. Set	11	18196	40 pc. Socket Set	24
16180	2-1/2 in. TT10 Double End Torsion Bit	137	17291	4 pc. 12 pt. SAE Jumbo Comb. Wr. Set	11	18198	52 pc. Socket Set	24
16181	2-1/2 in. TT15 Double End Torsion Bit	137	17292	10 pc. 12 pt. Metric Jumbo Comb. Wr. Set	10	18202	2 pc. 1/4 in. and 3/8 in. Dr. Gearless Micro Ratchet	75
16182	2-1/2 in. TT20 Double End Torsion Bit	137	17294	10 pc. 3/8in. Dr SAE Crowsfoot Wrench Set	5	18400	Convertible Snap Ring Pliers	36
16183	2.5 in. TT-25 Double End Torsion Bit	137	17295	10 pc. 3/8in. Dr MM Crowsfoot Wrench Set	5	18402	Snap Ring Plier Set	36
16184	1/4 in. Magnetic Nut Setter	137	17296	10 pc. 3/8in. Dr SAE Flare Nut Crowsfoot Wrench Set	5	18404	4 pc. 6 in. Plier Set	33
16185	5/16 in. Magnetic Nut Setter	137	17297	10 pc. 3/8 in. Dr. MM Flare Nut Crowsfoot Wrench Set	5	18405	5 pc. Mini Plier Set	33
16186	3/8 in. Magnetic Nut Setter	137	17298	14 pc. 1/2 in. Dr Jumbo SAE Crowsfoot Wrench Set	5	19000	1.4 mm HVLP Gravity Feed Spray Gun	152
16187	1/2 in. Magnetic Nut Setter	137	17299	14 pc. 1/2 in. Dr. Jumbo MM Crowsfoot Wrench Set	5	19014	1.4 mm HVLP Gravity Feed Spray Gun	152
16188	9/16 in. 65 mm Magnetic Nut Setter	137	17311	11 pc. 12 pt. Full Polished SAE Comb. Wr. Set	9	19015	Spray Gun Rebuild Kit for 19800	170
16190	14 pc. Torx® Bit Socket Set	27	17312	11 pc. 12 pt. Full Polish Metric Comb. Wr. Set	9	19018	1.8 mm HVLP Gravity Feed Spray Gun	152
16205	5 pc. 1 in. Imp. #2 PH Power Bit Set	140	17322	22 pc. 12 pt. Raised Panel SAE and Metric Comb. Wr. Set	6	19023	2.3 mm HVLP Gravity Feed Spray Gun	152
16206	2 pc. 2 in. Imp. #2 PH Power Bit Set	140	17327	11 pc. 12 pt. SAE Raised Panel Comb. Wr. Set	7	19100	3 pc. Dual Setup HVLP Spray Gun Kit	150
16207	3/8 in. Keyless Chuck Adapter	132	17328	11 pc. 12 pt. Metric Raised Panel Comb. Wr. Set	7	19110	1.0 mm HVLP Gravity Feed Touch Up Gun	153
16210	2 pc. #2 Phillips 2 in. Power Bits	136	17329	14 pc. 12 pt. SAE Raised Panel Comb. Wr. Set	7	19112	11 pc. Spray Gun Cleaning Kit	167
16211	2 pc. #2 Phillips 6in Power Bits	136	17330	16 pc. 12 pt. Metric Raised Panel Comb. Wr. Set	7	19113	1.3 mm Gravity Feed HVLP Spray Gun	153
16215	2 pc. #2 Phillips 6 in. Power Bit Set	139	17350	7 pc. 12 pt. SAE Rat. Comb. Wrench Set	13	19114	1.4 mm HVLP Gravity Feed Spray Gun	153
16220	2 pc. #2 Square Drive 2 in. Power Bits	136	17351	7 pc. 12 pt. Metric Rat. Comb. Wrench Set	13	19117	1.7 mm HVLP Gravity Feed Spray Gun	153
16221	2 pc. #2 Square Drive 6 in. Power Bits	136	17354	13 pc.12 pt. SAE Rat. Comb. Wrench Set	13	19120	2.0 mm HVLP Gravity Feed Spray Gun	153
16227	Swivel Bit Holder	134	17355	12 pc. 12 pt. Metric Rat. Comb. Wrench Set	13	19123	2.3 mm HVLP Gravity Feed Spray Gun	153
16228	3 pc. 1 in. Imp. Bit Set	140	17362	5 pc. 12 pt. SAE Rat. Comb. Wrench Set	13	19219	3 pc. HVLP Spray Gun Kit	150
16229	3 pc. 1 in. Imp. Bit Set	140	17363	5 pc. 12 pt. Metric Rat. Comb. Wrench Set	13	19220	4 pc. HVLP Triple Setup Spray Gun Kit	150
16230	2 pc. 2 in. 1/4 in. Slotted Power Bit Set	136	17364	13 pc. 12 pt. SAE Reversible Rat. Comb. Wrench Set	15	19221	4 pc. HVLP Triple Setup Spray Gun Kit	151
16231	2 pc. 6 in. 1/4 in. Slotted Power Bit Set	136	17365	12 pc. 12 pt. Metric Reversible Rat. Comb. Wrench Set	15	19223	4 pc. HVLP Dual Setup Spray Gun Kit	151
16232	10 pc. 2 in. Imp. Bit Set	140	17366	13 pc. 12 pt. SAE Flex Head Rat. Comb. Wrench Set	14	19225	6 in. Orbital Sander	149
16233	10 pc. 2 in. Imp. Bit Set	140	17367	13 pc. 12 pt. Metric Flex Head Rat. Comb. Wrench Set	14	19226	6 in. Sanding Pad	171
16234	2 pc. 2 in. Magnetic Driver Bit	139	17373	7 pc. 12 pt. SAE Stubby Comb. Wr. Set	7	19302	2 pc. Disposable Inline Moisture Filters	169
16235	Right-Angle Drill Attachment	132	17374	7 pc. 12 pt. Metric Stubby Comb. Wr. Set	7	19303	Locking Air Regulator and Gauge	169
16236	6 in. Quick-Release Ext. Bit Holder	134	17384	5 pc. 12 pt. SAE Comb. Wr. Set	6	19304	AMT 3-Way Composite Coupler - Female	165
16240	2 pc. 2-1/2 in. Fits-All-Phillips Bit Set	136	17385	5 pc. 12 pt. Metric Comb. Wr. Set	6	19305	AMT 3-Way Composite Coupler - Male	165
16251	50 pc. Torsion Imp. Bit Set	138	17388	3 pc. SAE Full Polish Flare Nut Wrench Set	12	19320	Thread Seal Tape	167
16501	1/8 in. to 1/2 in. #1 Step Drill Bit	132	17389	3 pc. Metric Full Polish Flare Nut Wrench Set	12	19321	Ball Foot Chuck	166
16503	3 pc. Step Drill Set	132	17394	9 pc. 12 pt. SAE Comb. Wr. Set	6	19322	2 pc. I/M Steel Male Plugs	165
16504	1/4 in. to 3/4 in. Step Drill Bit	132	17395	9 pc. 12 pt. Metric Comb. Wr. Set	6	19323	Female Ball Foot Chuck	166
16505	5 pc. Hex Shank Drill Bit Set	133	17396	18 pc. 12 pt. Fully Polished SAE and Metric Extra Long Comb. Wr. Set	8	19324	Dual Head Tire Chuck	166
16530	29 pc. Titanium Coated Drill Bit Set	133				19325	2 pc. I/M Steel Female Plugs	165
17000	3 pc. Scraper and Putty Set	65				19326	I/M Steel Female Coupler	165
17002	2 pc. Multi-Purpose Razor Scraper Set	66				19327	Swivel Plug	157
17004	4 pc. Seal and O-Ring Remover Set	57				19329	Thread Seal Tape	167
17005	2 pc. Stainless Steel Pry Bar/Scraper Set	63				19330	4 pc. I/M Connector Kit	165
17007	3 pc. Pry Bar Set	63				19333	5 pc. I/M Coupler and Plug Set	165
17008	22 pc. Multi-Purpose Razor Scraper Set	66				19334	Female Air Chuck With Clip	166
17009	4 pc. Pry Bar Set	63				19336	5 pc. 3 in. x 1/16 in. Cut-Off Wheels	171
17010	5/8 in. Carbide Scraper	62						
17011	1-1/4 in. Carbide Scraper	62						

Part #	Description	Page #	Part #	Description	Page #	Part #	Description	Page #
19337	7 pc. Blow Gun Kit	159	19610	2-quart Spray Gun Kit	154	21308	8 in. Heavy-Duty Straight Pipe Wrench	17
19338	17 pc. I/M Air Line Accessory Kit	164	19699	19 pc. Air Tool Kit	147	21310	10 in. Heavy-Duty Straight Pipe Wrench	17
19341	Air Line Inflator Gauge	163	19710	2 pc. Air Hammer Retainer Springs	171	21312	12 in. Heavy-Duty Straight Pipe Wrench	17
19343	I/M Steel Male Coupler	165	19715	1/4 in. 6 mm Angle Die Grinder	147	21314	14 in. Heavy-Duty Straight Pipe Wrench	17
19344	Tire Inflator and Dial Gauge	163	19732	3/8 in. Dr. Air Ratchet Wrench	146	21315	12 in. Strap Wrench	4
19345	3/8 in. Hose Mender	157	19735	Mini Orbital Sander	148	21316	18 in. Strap Wrench	4
19346	3/8 in. Hose Ends	157	19736	Mini Disc Sander	148	21318	18 in. Heavy-Duty Straight Pipe Wrench	17
19352	5 pc. Grinding Stone Assortment	171	19737	1/4 in. Mini Air Die Grinder	148	21319	9 in. Auto Wrench	3
19355	4 pc. Air Chisel Set	171	19741	Double Barrel Foot Pump	162	21321	11 in. Auto Wrench	3
19356	4 pc. Inflator Kit	162	19745	Foot Pump	162	21324	24 in. Heavy-Duty Straight Pipe Wrench	17
19357	Digital Tire Inflator	163	19746	3 in. Air Cut-Off Tool	147	21325	15 in. Auto Wrench	3
19358	20 in. Swivel Replacement Hose for 19357 Digital Tire Inflator	163	19747	Air Die Grinder	148	21330	10 in. Aluminum Straight Pipe Wrench	17
19359	Airflow Regulator with Gauge	156	19748	1/2 in. Dr. Imp. Wrench	146	21334	14 in. Aluminum Straight Pipe Wrench	17
19360	Pistol Grip Nylon Blow Gun	161	19749	3/8 in. Dr. Air Ratchet	146	21336	36 in. Heavy-Duty Straight Pipe Wrench	17
19361	Double Male Connector	157	19800	3 pc. Dual Set Up HVLP Spray Gun Kit	151	21337	48 in. Heavy-Duty Straight Pipe Wrench	17
19368	1/4 in. x 25 ft. Polyurethane Recoil Air Hose	155	19900	600ml Plastic Cup and Lid	168	21338	18 in. Aluminum Straight Pipe Wrench	17
19369	Swivel Air Regulator/Connector	158	19902	2 pc. Plastic Lid for 150 ml. Paint Cup	168	21344	24 in. Aluminum Straight Pipe Wrench	17
19371	3/8 in. x 50 ft. PVC Air Hose	156	19903	150 ml. Stainless Steel Paint Cup	168	21346	36 in. Aluminum Straight Pipe Wrench	17
19375	3/8 in. x 35 ft. Rubber Air Hose	156	19906	1000 ml. Aluminum Paint Cup and Lid	168	21348	48 in. Aluminum Straight Pipe Wrench	17
19376	3/8 in. x 50 ft. Rubber Air Hose	156	19907	1000 ml. Paint Cup Replacement Lid	168	21370	12 in. Chain Wrench	4
19378	Inline Blow Gun	160, 186	19908	Spray Gun Rebuild Kit for 19000 Series	170	21372	24 in. Chain Wrench	4
19380	Pocket Blow Gun	160	19909	Spray Gun Rebuild Kit for 19100 Series	170	22003	4 in. Replacement Jaw for General Purpose Bench Vise	70
19381	Twin Pack Air Blow Gun	161	19910	Spray Gun Rebuild Kit for Touch Up Gun	170	22004	4 in. Replacement Jaw for Industrial Utility Bench Vise	70
19382	3/8 in. x 50 ft. Rubber Air Hose	156	19911	5 pc. In-Line Paint Filter	169	22005	5 in. Replacement Jaw for Multi-Purpose Bench Vise	70
19387	20 in. Air Blow Gun	161	19951	17 in. x 2-3/4 in. Flexible Sanding Block	203	22006	5 in. Replacement Jaw for General Purpose Bench Vise	70
19388	30 in. Air Blow Gun	161	19952	5 in. x 2-3/4 in. Flexible Sanding Block	203	22007	5 in. Replacement Jaw for Industrial Utility Bench Vise	70
19389	40 in. Air Blow Gun	161	19959	7 in. x 4 in. Flexible Sanding Block	203	22008	6 in. Replacement Jaws for General Purpose Bench Vise	70
19391	4 pc. Air Blow Gun Set	161	19990	Air Spray Gun Holder	169	22009	6 in. Replacement Jaw for Industrial Utility Bench Vise	70
19402	Blow Gun with Removable Venturi Tip	161	19991	Magnetic Spray Gun Holder	169	22010	4 in. General Purpose Swivel-Base Bench Vise	69
19404	Safety Tip Mini Blow Gun	160	19992	24 in. Blow Gun	159	22011	4 in. Industrial Utility Bench Vise	69
19405	Turbo Venturi Mini Blow Gun	160	19993	36 in. Blow Gun	159	22012	5 in. Multi-Purpose Vise	70
19417	Siphon Feed Detail Spray Gun	154	19994	48 in. Blow Gun	159	22013	5 in. General Purpose Swivel-Base Bench Vise	69
19418	1.8 mm Siphon Feed Production Spray Gun	154	19995	12 in. Blow Gun	159	22014	5 in. Industrial Utility Bench Vise	69
19419	Spot Spray Non-Aerosol Sprayer	154	19996	6 in. Blow Gun	160	22015	6 in. General Purpose Swivel-Base Bench Vise	69
19420	Spot Spray Rebuild Kit	154	21005	4 pc. 4 in. Heavy-Duty Swivel Casters	226	22016	6 in. Industrial Utility Bench Vise	69
19421	Twin Pack Spot Spray Set	154	21006	Professional Workbench	226	22017	Camo Moving Blanket	221
19424	Spot Spray Non-Aerosol Sprayer	154	21080	14 in. SAE/Metric Lug Wrench	226	22018	8 in. Industrial Utility Bench Vise	69
19430	2 pc. A-Style Female Plugs	164	21081	14 in. SAE/Metric Folding Lug Wrench	226	22019	2pc 4-1/2 in. Non-Marring Magnetic Vise Jaw Pads	71
19431	2 pc. A-Style Male Plugs	164	21083	3/4 in. L-Type Lug Wrench	226	22020	2pc 6 in. Non-Marring Magnetic Vise Jaw Pads	71
19432	2 pc. T-Style Female Plugs	164	21084	13/16 in. L-Type Lug Wrench	226	22033	1 Pin Multi-Purpose Funnel	185
19433	2 pc. T-Style Male Plugs	164	21085	7/8 in. L-Type Lug Wrench	226	22034	11 in. Multi-Purpose Funnel	185
19434	1/4 in. Hose Mender Kit	157	21086	22 in. SAE/Metric Lug Wrench	226	22035	18 in. Multi-Purpose Funnel	185
19435	Rubber Tipped Blow Gun	160	21091	17 mm 1/2 in. Dr. Lug Nut Socket	225	22036	7 Quart Drain Pan	185
19436	8 pc. Blow Gun Kit	159	21092	19 mm 1/2 in. Dr. Lug Nut Socket	225	22037	36 in. x 25 in. Galvanized Drip Pan	185
19437	Universal Coupler	166	21093	21 mm 1/2 in. Dr. Lug Nut Socket	225	22052	2-1/2 in. Clamp-on Table Vise	71
19439	1/4 in. NPT Tee Fitting	158	21094	22 mm 1/2 in. Dr. Lug Nut Socket	225	22053	3 in. Clamp-on Table Vise	71
19440	1/4 in. Male to 1/4in Female Coupling	157	21095	4 pc. 1/2 in. Dr. Lug Nut Socket	225	22055	5 in. Gen. Purpose Fixed-Base Bench Vise	69
19441	1/4 in. Female to 1/4 in. Female Coupling	157	21117	1/2 in. Dr. x 17 mm XL Lug Nut Socket	225	22056	6 in. Gen. Purpose Fixed-Base Bench Vise	69
19442	In-Line Air Flow Regulator	158	21119	1/2 in. Dr. x 19 mm XL Lug Nut Socket	225	22057	5 in. Quick-Release Swivel-Base Vise	70
19443	20 pc. Air Accessory Set	167	21121	1/2 in. Dr. x 21 mm XL Lug Nut Socket	225	22058	8 in. Gen. Purpose Fixed-Base Bench Vise	69
19444	360 Degree Swivel Connector	158	21122	1/2 in. Dr. x 22 mm XL Lug Nut Socket	225	22059	10 in. General Purpose Swivel-Base Vise	69
19445	2-Way Swivel Splitter	158	21216	12 pc. Utility Box Dividers	222	22400	Heat Gun	131
19446	3-Way Swivel Splitter	158	21218	18 in. 3-Way Stackable Storage Tote	222	22501	2 pc. 10 in. Replacement Bonnets	131
19450	Sand Blaster	149	21222	22 in. 3-Way Stackable Storage Tote	222	22502	2 pc. 6 in. Replacement Bonnets	131
19451	Sandblaster Ceramic Tip	171	21260	3 pc. Magnetic Tray Set	52	22508	7 in. Replacement Rubber Polishing Pad	130
19460	5 pc. High Flow Coupler and Plug Set	164	21261	5 7/8 in. Round Magnetic Tray	52	22509	7 in. Replacement Hook and Loop Sanding Pad	130
19461	AMT 3-Way Quick-Connect Coupler	166	21262	10-1/2 in. x 11-1/2 in. Large Square Magnetic Parts Tray	53			
19464	3/8 in. x 25 ft. Hybrid Air Hose	155	21263	6-1/2 in. x 14 in. Rectangular Magnetic Parts Tray	53			
19465	3/8 in. x 50 ft. Hybrid Air Hose	155	21264	5-7/8 in. Round Magnetic Parts Tray	189			
19466	3/8 in. x 100 ft. Hybrid Air Hose	155	21265	Rectangular Magnetic Parts Tray	53			
19469	3/8 in. X 25ft. PVC Air Hose	155	21267	Multi-Purpose Organizer	221			
19484	1/4 in. x 25 ft. Flexible Hybrid Air Hose	155	21268	Multi-Purpose Organizer	221			
19485	1/4 in. x 50 ft. Flexible Hybrid Air Hose	155	21269	12-Drawer Multi Purpose Organizer	221			
19486	1/4 in. x 100 ft Flexible Hybrid Air Hose	155	21304	4 pc. Heavy-Duty Straight Pipe Wrench Set	17			
19551	Dual Action Gravity Feed Airbrush	153						

Part #	Description	Page #	Part #	Description	Page #	Part #	Description	Page #
22511	Flange and Wrench Set	130	41222	Soap Stone Holder	176	42318	9/16 in. 1/2 in. Dr. 6 pt. SAE Imp. Skt.	122
22512	Replacement Motor Brushes	130	41223	Welding Tip Cleaner	177	42319	19 pc. 1/2 in. Dr. SAE Deep Imp. Skt. Set	120
22530	11-Amp 7 in. Polisher Sander	130	41225	Chipping Hammer	176	42320	5/8 in. 1/2 in. Dr. 6 pt. SAE Imp. Skt.	122
22606	6 in. Random Orbital Buffer/Polisher	131	41226	Small Brass Wire Brush	177	42322	11/16 in. 1/2 in. Dr. 6 pt. SAE Imp. Skt.	122
22610	10 in. Orbital Electric Polisher	131	41227	Small Stainless Steel Wire Brush	177	42324	3/4 in. 1/2 in. Dr. 6 pt. SAE Imp. Skt.	122
22958	Mini Air Compressor	156	41228	Stainless Steel Shoe Horn Wire Brush	178	42326	13/16 in. 1/2 in. Dr. 6 pt. SAE Imp. Skt.	122
22959	10 ft. Braided Air Hose	156	41229	Stainless Steel Wire Brush	178	42328	7/8 in. 1/2 in. Dr. 6 pt. SAE Imp. Skt.	122
23140	1/4 in. Dr. Beam Type Torque Wrench	22	41230	1/16 in. Fast Fill Welding Rods	179	42330	15/16 in. 1/2 in. Dr. 6 pt. SAE Imp. Skt.	122
23141	3/8 in. Drive Beam Type Torque Wrench	22	41231	5/64 in. General Purpose Welding Rods	179	42332	1 in. 1/2 in Drive 6 pt. SAE Imp. Skt.	122
23142	1/2 in. Dr. Beam Type Torque Wrench	22	41232	1/16 in. General Purpose Welding Rods	179	42334	1-1/16 in. 1/2 in. Dr. 6 pt. SAE Imp. Skt.	122
23146	1/4 in. Dr. Micrometer Torque Wrench	22	41233	3/32 in. Brass Brazing Rods	179	42336	1-1/8 in. 1/2 in. Dr. 6 pt. SAE Imp. Skt.	122
23147	3/8 in. Dr. Micrometer Torque Wrench	22	41234	1/8 in. Deep Penetrating Welding Rods	179	42340	1-1/4 in. 1/2 in. Dr. 6 pt. SAE Imp. Skt.	122
23148	1/2 in. Dr. Micrometer Torque Wrench	22	41235	Brazing and Cutting Goggles	176	42355	1/2 in. x 3/8 in. Dr. Reducing Adapter	119
23150	1/2 in. Dr. Reversible Torque Wrench	23	41236	1/8 in. Deep Penetrating Welding Rods	179	42356	1/2 in. x 3/4 in. Dr. Increasing Adapter	122
23151	1/2 in. Dr. Reversible Micro Torque Wrench	23	41237	1/8 in. General Purpose Welding Rods	179	42357	3/4 in. x 1/2 in. Reducing Adapter	124
23152	3/4 in. Dr. Torque Wrench	23	41238	3/32 in. Deep Penetrating Welding Rods	179	42358	3/4 in. x 1 in. Increasing Adapter	124
23154	1/2 in. Digital Torque Adapter	23	41239	Welding Gloves	176	42359	1 in. x 3/4 in. Reducing Adapter	126
23171	Composite Digital Caliper	54	41240	.030 Mig Wire	179	42404	14 pc. 1/2 in. Dr. Metric Deep Imp. Skt. Set	121
23173	Fractional Digital Caliper	54	41241	.035 Mig Wire	179	42406	26 pc. 1/2 in. Dr. Metric Deep Imp. Skt. Set	121
23175	Electronic Digital Caliper	54	41242	.030 Flux Core Wire	179	42410	10 mm 1/2 in. Dr. 6 pt. Metric Imp. Skt.	122
30931	Tool Box Drawer Liner	222	41244	.030 Aluminum Wire	179	42411	11 mm 1/2 in. Dr. 6 pt. Metric Imp. Skt.	122
30936	3 pc. Low Profile Imp. Adapter Set	128	41245	.035 Flux Core Wire	179	42412	12 mm 1/2 in. Dr. 6 pt. Metric Imp. Skt.	122
32097	1/2 in. Dr. SAE Mag. Aluminum Socket Rail	224	41247	Fixed Shade Welding Helmet	174	42413	13 mm 1/2 in. Dr. 6 pt. Metric Imp. Skt.	122
32098	1/2 in. Dr. Metric Mag. Aluminum Socket Rail	224	41249	.024 Contact Tips	178	42414	14 mm 1/2 in. Dr. 6 pt. Metric Imp. Skt.	122
32099	1/2 in. Dr. Metric Anodized Socket Holder	224	41250	.030 Contact Tips	178	42415	15 mm 1/2 in. Dr. 6 pt. Metric Imp. Skt.	122
32910	10 pc. Tamp. Resist. Star Key Set	195	41251	.035 Contact Tips	178	42416	16 mm 1/2 in. Dr. 6 pt. Metric Imp. Skt.	122
32913	Backscratcher Magnetic Pick up Tool	196	41252	Welding Nozzle	178	42417	17 mm 1/2 in. Dr. 6 pt. Metric Imp. Skt.	122
32948	Water Heater Socket	61	41254	Auto Darkening Welding Helmet	172	42418	18 mm 1/2 in. Dr. 6 pt. Metric Imp. Skt.	122
32963	22 pc. Titanium Drill Bit	195	41260	Solar Powered Auto Dark Welding Helmet	172	42419	19 mm 1/2 in. Dr. 6 pt. Metric Imp. Skt.	122
32964	33 pc. Security Bit Set	196	41261	Clear Protective Replacement Lenses	172	42421	21 mm 1/2 in. Dr. 6 pt. Metric Imp. Skt.	122
32965	6-in-1 Screwdriver	198	41262	Solar Powered Auto Dark Welding Helmet	173	42422	22 mm 1/2 in. Dr. 6 pt. Metric Imp. Skt.	122
32966	1/4 in. Dr. Offset Micro Ratchet	198	41263	Replacement Headgear for Welding Helmet	173	42424	24 mm 1/2 in. Dr. 6 pt. Metric Imp. Skt.	122
32967	Mini Razor Scraper	196	41264	Clear Protective Replacement Lenses	173	42426	26 mm 1/2 in. Dr. 6 pt. Metric Imp. Skt.	122
32968	Mini Sliding Utility Knife	195	41265	Solar Powered Auto Dark Welding Helmet	173	42427	27 mm 1/2 in. Dr. 6 pt. Metric Imp. Skt.	122
32970	Pry Bar	197	41266	Solar Powered Auto Dark Welding Helmet	173	42430	30 mm 1/2 in. Dr. 6 pt. Metric Imp. Skt.	122
32971	2.2x Magnifying Glass	196	41267	Solar Powered Auto Dark Welding Helmet	173	42432	32 mm 1/2 in. Dr. 6 pt. Metric Imp. Skt.	122
32972	31 pc. Bit Driver Set	198	41279	Solar Powered Auto Dark Welding Helmet	173	42906	6 pc. 1/2 in. Dr. Metric Imp. Hex Bit Socket Set	127
32973	4 pc. Socket Adapter Set	197	41282	Solar Powered Auto Dark Welding Helmet	173	42925	5 pc. 1/2 in. Dr. SAE Imp. Hex Bit Socket Set	127
32974	5-1/2 in. Mini Wrecking Bar	197	41283	Solar Powered Auto Dark Welding Helmet	173	42977	7 pc. 1/2 in. Dr. Imp. Star Bit Socket Set	127
32975	3 pc. Socket Adapter Set	197	41288	Solar Powered Auto Dark Welding Helmet	173	44003	3/4 in. Dr. x 4 in. Imp. Ext. Bar	124
32976	4 pc. Precision Pick Set	195	41289	Solar Powered Auto Dark Welding Helmet	173	44008	3/4 in. Dr. x 6 in. Imp. Ext. Bar	124
36006	Pocket Flashlight	187	41290	Solar Powered Auto Dark Welding Helmet	173	44010	3/4 in. Dr. x 10 in. Imp. Ext. Bar	124
36016	60-Lumen LED Mini Flashlight	187	41291	Small Magnetic Support Jig	177	44013	3/4 in. Dr. x 13 in. Imp. Ext. Bar	124
36097	1/4 in. Dr. SAE Mag. Aluminum Socket Rail	224	41292	Medium Magnetic Support Jig	177	44101	4 pc. 3/4 in. SAE Imp. Jumbo Hex Bit Socket Set	127
36098	1/4 in. Dr. Metric Mag. Aluminum Socket Rail	224	41294	Large Magnetic Support Jig	177	44130	3/4 in. Dr. U-Joint	124
38097	3/8 in. Dr. SAE Mag. Aluminum Socket Rail	224	41908	8 pc. 1 in. Dr. Metric Deep Imp. Skt. Set	125	44300	8 pc. 3/4 in. Dr. SAE Deep Imp. Skt. Set	123
38098	3/8 in. Dr. Metric Mag. Aluminum Socket Rail	224	41924	2x Magnifying Lens	173	44505	5 pc. 3/4 in. Dr. Imp. Jumbo Hex Bit Socket Set	127
40000	8 pc. Imp. Skt. Adapter Set	128	42100	6 pc. 1/2 in. Dr. Imp. Skt. Acc. Set	119	44600	8 pc. 3/4 in. Dr. Metric Deep Imp. Skt.	123
40109	9 pc. Assorted Imp. Ext. Bar Set	128	42130	1/2 in. Dr. Imp. Skt. U-Joint	119	45000	Solar Powered Auto Dark Welding Helmet	172
40144	1 in. Dr. x 4 in. Imp. Ext. Bar	126	42140	3 pc. 1/2 in. Dr. Imp. Ext. Bar Set	119	45001	2 pc. Clear Protective Replacement Lenses	172
40146	1 in. Dr. x 6 in. Imp. Ext. Bar	126	42143	1/2 in. Dr. x 3 in. Imp. Ext. Bar	119	45200	200 pc. Spring Assortment	216
40150	1 in. Dr. x 10 in. Imp. Ext. Bar	126	42145	1/2 in. Dr. x 5 in. Imp. Ext. Bar	119	45201	270 pc. HNBR O-Ring Assortment	210
40153	1 in. Dr. x 13 in. Imp. Ext. Bar	126	42150	1/2 in. Dr. x 10 in. Imp. Ext. Bar	119	45202	407 pc. SAE O-Ring Assortment	211
40160	3 pc. Imp. Skt. U-Joint Set	129	42157	1/2 in. x 3/8 in. Dr. Locking Wobble Reducing Adapter	119	45203	419 pc. Metric O-Ring Assortment	211
40309	9 pc. 1 in. Dr. SAE Deep Imp. Skt. Set	125	42158	1/2 in. x 3/4 in. Dr. Locking Wobble Increasing Adapter	119	45204	1000 pc. Cotter Pin Assortment	212
41185	90-amp Gasless Wire Feed Welder	174	42160	1/2 in. Dr. Pin-Free Locking U-Joint	119	45205	555 pc. Cotter Pin Assortment	212
41191	20 pc. Mig Welder Contact Tips	178	42173	3 pc. 1/2 in. Dr. Extra-Long Imp. Ext. Set	119	45206	144 pc. Large Cotter Pin Assortment	212
41192	8 in. Flat Jaw Welding Pliers	177	42175	1/2 in. Dr. x 18 in. Extra-Long Imp. Ext. Bar	119	45207	20 pc. Hose Clamp Assortment	209
41193	#2 Oxygen/Acetylene Welding Tip	179	42176	1/2 in. Dr. x 24 in. Extra-Long Imp. Ext. Bar	119	45208	300 pc. E-Clip Assortment	215
41194	#6 Oxygen/Acetylene Welding Tip	179	42177	1/2 in. Dr. x 36 in. Extra-Long Imp. Ext. Bar	119	45209	22 pc. Dual-Wall Heat Shrink Tube Assort.	207
41195	2 pc. Mig Torch Gas Nozzles	178	42312	3/8 in. 1/2 in. Dr. 6 pt. SAE Imp. Skt.	122	45210	150 pc. Pin Hitch Assortment	213
41196	4 in. Magnetic Ground Block	177	42313	13 pc. 1/2 in. Dr. SAE Deep Imp. Skt. Set	120	45212	300 pc. Snap Ring Assortment	215
41197	Welding Cart	175	42314	7/16 in. 1/2 in. Dr. 6 pt. SAE Imp. Skt.	122			
41198	180-Amp Dual System Mig-Arc Welder	175	42316	1/2 in. 1/2 in. Dr. 6 pt. SAE Imp. Skt.	122			
41199	30-Amp Plasma Cutter	175						
41221	Round Soap Stones	176						

Part #	Description	Page #	Part #	Description	Page #	Part #	Description	Page #
45214	125 pc. Rubber Grommet Assortment	214	51502	4-in-1 Quick-Change Tube Bender Pliers	183	60043	1-3/4 in. Jumbo Comb.	11
45215	70 pc. Grease Fitting Assortment	208	51503	Mini Tubing Bender	183	60044	1-7/8 in. Jumbo Comb.	11
45217	110 pc. Copper Washer Assortment	216	51505	3 pc. Mini Wire Brush Set	205	60045	2 in. Jumbo Comb.	11
45220	200 pc. Hex Head Screw Assortment	213	51507	Door Upholstery Remover	184	60046	2-1/8 in. Jumbo Comb.	11
45225	225 pc. SAE O-Ring Assortment	211	51535	3/16 in. Double Flaring Tool	183	60047	2-1/4 in. Jumbo Comb.	11
45227	96 pc. Blade Fuse Assortment	206	51572	3 in. Heavy Duty C-Clamp	72	60048	2-3/8 in. Jumbo Comb.	11
45228	500 pc. Aluminum Rivet Assortment	215	51573	4 in. Heavy Duty C-Clamp	72	60049	2-1/2 in. Jumbo Comb.	11
45229	96 pc. Mini Blade Fuse Assortment	207	51574	5 in. Heavy Duty C-Clamp	72	60066	1-11/16 in. Jumbo Comb.	11
45230	88 pc. Master Auto Fuse Assortment	206	51575	6 in. Heavy Duty C-Clamp	72	60068	1-13/16 in. Jumbo Comb.	11
45231	71 pc. Micro 2-Fuse Assortment	207	51578	8 in. Heavy Duty C-Clamp	72	60109	34 mm Jumbo Comb.	11
45232	24 pc. Maxi Blade Fuse Assortment	206	51580	10 in. Heavy Duty C-Clamp	72	60111	36 mm Jumbo Comb.	11
45235	160 pc. SAE Hex Head Screw Assortment	214	51582	12 in. Heavy Duty C-Clamp	72	60112	38 mm Jumbo Comb.	11
45236	110 pc. Rubber Grommet Assortment	214	51600	Brake Caliper Hanger Set	180	60113	41 mm Jumbo Comb.	11
45237	36 pc. Low Profile Mini Fuse Assortment	206	51613	Fuel and Air Conditioning Line Disconnect Tool	183	60114	42 mm Jumbo Comb.	11
45238	171 pc. Heat Shrink Tube Assortment	208	51614	Fuel Line Disconnect Tool	183	60115	46 mm Jumbo Comb.	11
45239	106 pc. Dual-Wall Heat Shrink Tube Assort.	207	51700	Honda/Acura Crankshaft Pulley Holder	182	60117	50 mm Jumbo Comb.	11
45240	550 pc. Nail Assortment	209	51704	Oxygen Sensor Socket	182	60130	30 mm Jumbo Comb.	11
45243	100 pc. Metric Nylon Locknut Assortment	209	51739	Offset Oxygen Sensor Wrench	182	60131	31 mm Jumbo Comb.	11
45245	555 pc. Large Stainless Steel Cotter Pin Assortment	213	51801	Tie Rod Separator	181	60132	32 mm Jumbo Comb.	11
45249	20 pc. Clevis Pin Assortment	212	51802	Ball Joint Separator	181	60133	33 mm Jumbo Comb.	11
45250	475 pc. Metric Nut and Bolt Assortment	210	51830	1/2 in. Dr. 1-11/16 in. Dodge Spindle	181	60135	35 mm Jumbo Comb.	11
45251	160 pc. Metric Hex Head Screw Assortment	214	51884	Automotive Fluid Syringe	184	60208	1/4 in. Mirror Polish 12 pt. Comb.	9
45252	80 pc. Vacuum Cap Assortment	216	51885	1-Liter Vacuum Brake Fluid Bleeder	180	60210	5/16 in. Mirror Polish 12 pt. Comb.	9
45274	110 pc. Metric Grease Fit Assortment	208	51886	Propane Heat Gun	221	60212	3/8 in. Mirror Polish 12 pt. Comb.	9
45307	106 pc. Metric Socket Screw Assortment	215	51912	2 in. Heavy Duty C-Clamp	72	60214	7/16 in. Mirror Polish 12 pt. Comb.	9
45333	240 pc. Zinc USS Nut and Bolt Assortment	210	52080	5 pc. 5 in. 80 Grit Sand Paper	204	60216	1/2 in. Mirror Polish 12 pt. Comb.	9
45334	240 pc. Zinc Metric Nut and Bolt Assortment	210	52150	5 pc. 5 in. 150 Grit Sand Paper	204	60218	9/16 in. Mirror Polish 12 pt. Comb.	9
45339	158 pc. Wire Nut Assortment	208	52240	5 pc. 5 in. 240 Grit Sand Paper	205	60220	5/8 in. Mirror Polish 12 pt. Comb.	9
45342	120 pc. Roll Pin Assortment	213	52320	5 pc. 5 in. 320 Grit Sand Paper	205	60222	11/16 in. Mirror Polish 12 pt. Comb.	9
45343	295 pc. Shop Assortment	216	54137	43 pc. Master Star Bit Socket Set	112	60224	3/4 in. Mirror Polish 12 pt. Comb.	9
45348	34 pc. Hose Clamp Assortment	209	59080	5 pc. 7 in. 80 Grit Sand Paper	204	60226	13/16 in. Mirror Polish 12 pt. Comb.	9
46053	53 pc. 1/4 in. Dr. SAE and Metric Combination Imp. Skt. Set	116	59150	5 pc. 7 in. 150 Grit Sand Paper	204	60228	7/8 in. Mirror Polish 12 pt. Comb.	9
46155	1/4 in. to 3/8 in. Dr. Increasing Adapter	116	59240	5 pc. 7 in. 240 Grit Sand Paper	205	60230	15/16 in. Mirror Polish 12 pt. Comb.	9
46157	1/4 in. to 3/8 in. Dr. Locking Wobble Increasing Adapter	116	59320	5 pc. 7 in. 320 Grit Sand Paper	205	60232	1 in. Mirror Polish 12 pt. Comb.	9
46158	1/4 in. Drive Pin-Free Locking U-Joint	116	60002	1-5/16 in. Jumbo Comb.	11	60234	1-1/16 in. Mirror Polish 12 pt. Comb.	9
48100	6 pc. 3/8 in. Dr. Imp. Skt. Accessory Set	117	60003	1-7/16 in. Jumbo Comb.	11	60236	1-1/8 in. Mirror Polish 12 pt. Comb.	9
48130	3/8 in. Dr. U-Joint	117	60006	6 mm Mirror Polish 12 pt. Comb.	9	60238	1-3/16 in. Mirror Polish 12 pt. Comb.	9
48140	3 pc. 3/8 in. Dr. Imp. Ext. Bar Set	117	60007	7 mm Mirror Polish 12 pt. Comb.	9	60240	1-1/4 in. Mirror Polish 12 pt. Comb.	9
48158	3/8 in. x 1/2 in. Dr. Locking Wobble Increasing Adapter	117	60008	8 mm Mirror Polish 12 pt. Comb.	9	60402	3/8 in. x 7/16 in. Mirror Polished Flare Nut Wrench	12
48159	3/8 in. x 1/4 in. Dr. Locking Wobble Reducing Adapter	117	60009	9 mm Mirror Polish 12 pt. Comb.	9	60403	1/2 in. x 9/16 in. Mirror Polished Flare Nut Wrench	12
48160	3/8 in. Dr. Pin-Free Locking U-Joint	117	60010	10 mm Mirror Polish 12 pt. Comb.	9	60404	5/8 in. x 11/16 in. Mirror Pol Flare Nut Wrench	12
48300	12 pc. 3/8 in. Dr. SAE Deep Imp. Skt. Set	118	60011	11 mm Mirror Polish 12 pt. Comb.	9	60405	3/4 in. x 7/8 in. Mirror Polished Flare Nut Wrench	12
48354	3/8 in. x 1/2 in. Dr. Increasing Imp. Adapter	117	60012	12 mm Mirror Polish 12 pt. Comb.	9	60409	9 x 11 mm Mirror Pol Flare Nut Wrench	12
48355	3/8 in. x 1/4 in. Dr. Reducing Imp. Adapter	117	60013	13 mm Mirror Polish 12 pt. Comb.	9	60410	10 x 12mm Mirror Polished Flare Nut Wrench	12
48400	13 pc. 3/8 in. Dr. Metric Deep Imp. Skt. Set	118	60014	14 mm Mirror Polish 12 pt. Comb.	9	60413	13 mm x 14 mm Mirror Pol Flare Nut Wrench	12
49003	3 pc. 2-3/4 in. Imp. Wobble Socket Adapter	143	60015	15 mm Mirror Polish 12 pt. Comb.	9	60415	15 mm x 17mm Mirror Polished Flare Nut Wrench	12
49006	3 pc. 6 in. Imp. Wobble Socket Adapter	143	60016	16 mm Mirror Polish 12 pt. Comb.	9	60416	16 x 18 mm Mirror Polished Flare Nut Wrench	12
49012	3 pc. Imp. Wobble Socket Adapter Set	143	60017	17 mm Mirror Polish 12 pt. Comb.	9	60419	19 x 21 mm Mirror Polished Flare Nut Wrench	12
49036	6 pc. Imp. Wobble Socket Adapter Set	143	60018	18 mm Mirror Polish 12 pt. Comb.	9	60720	6 in. Slip Joint Pliers	34
49089	9 pc. Imp. Wobble Socket Adapter Set	143	60019	19 mm Mirror Polish 12 pt. Comb.	9	60721	8 in. Slip Joint Pliers	34
50009	Pencil Style Tire Pressure Gauge	186	60020	20 mm Mirror Polish 12 pt. Comb.	9	60722	10 in. Slip Joint Pliers	34
50013	Pocket Tire Gauge	186	60021	21 mm Mirror Polish 12 pt. Comb.	9	60725	6 in. Diagonal Pliers	34
51080	5 pc. 17 in. 80 Grit Sand Paper	204	60022	22 mm Mirror Polish 12 pt. Comb.	9	60726	8 in. Diagonal Pliers	34
51150	5 pc. 17 in. 150 Grit Sand Paper	204	60023	23 mm Mirror Polish 12 pt. Comb.	9	60727	8 in. Linesman Pliers	34
51240	5 pc. 17 in. 240 Grit Sand Paper	205	60024	24 mm Mirror Polish 12 pt. Comb.	9	60731	6 in. Long Nose Pliers	34
51310	Slide Hammer Puller Set	180	60025	25 mm Mirror Polish 12 pt. Comb.	9	60732	6 in. Bent Long Nose Pliers	34
51320	5 pc. 17 in. 320 Grit Sand Paper	205	60026	26 mm Mirror Polish 12 pt. Comb.	9	60733	8 in. Long Nose Pliers	34
51362	Blind Hole Bearing Puller	180	60027	27 mm Mirror Polish 12 pt. Comb.	9	60741	10 in. Groove Joint Pliers	34
51408	High Temp Infrared Thermometer	184	60028	28 mm Mirror Polish 12 pt. Comb.	9	60743	12 in. Groove Joint Pliers	34
51500	AC Fin Comb	182	60029	29 mm Mirror Polish 12 pt. Comb.	9			
			60030	30 mm Mirror Polish 12 pt. Comb.	9			
			60032	32 mm Mirror Polish 12 pt. Comb.	9			
			60040	1-3/8 in. Jumbo Comb.	11			
			60041	1-1/2 in. Jumbo Comb.	11			
			60042	1-5/8 in. Jumbo Comb.	11			

Part #	Description	Page #	Part #	Description	Page #	Part #	Description	Page #
60745	16 in. Groove Joint Pliers	34	62024	3/4 in. 1/2 in. Dr. 6 pt. Socket	100	62411	11 mm 1/2 in. Dr. Deep Socket	101
60752	5 in. Curve Jaw Locking Pliers	35	62026	13/16 in. 1/2 in. Dr. 6 pt. Socket	100	62412	12 mm 1/2 in. Dr. Deep Socket	101
60754	7 in. Curve Jaw Locking Pliers	35	62028	7/8 in. 1/2 in. Dr. 6 pt. Socket	100	62413	13 mm 1/2 in. Dr. Deep Socket	101
60756	10 in. Curve Jaw Locking Pliers	35	62030	15/16 in. 1/2 in. Dr. 6 pt. Socket	100	62414	14 mm 1/2 in. Dr. Deep Socket	101
60757	10 in. Straight Jaw Locking Pliers	35	62032	1 in. 1/2 in. Dr. 6 pt. Socket	100	62415	15 mm 1/2 in. Dr. Deep Socket	101
60758	6 in. Long Nose Locking Pliers	35	62034	1-1/16 in. 1/2 in. Dr. 6 pt. Socket	100	62416	16 mm 1/2 in. Dr. Deep Socket	101
60760	9 in. Long Nose Locking Pliers	35	62036	1-1/8 in. 1/2 in. Dr. 6 pt. Socket	100	62417	17 mm 1/2 in. Dr. Deep Socket	101
60771	11 in. Long Nose Pliers	34	62038	1-3/16 in. 1/2 in. Dr. 6 pt. Socket	100	62418	18 mm 1/2 in. Dr. Deep Socket	101
60773	11 in. 45° Long Nose Pliers	34	62040	1-1/4 in. 1/2 in. Dr. 6 pt. Socket	100	62419	19 mm 1/2 in. Dr. Deep Socket	101
60774	11 in. 90° Long Nose Pliers	34	62101	1/2 in. Dr. Teardrop Ratchet	99	62420	20 mm 1/2 in. Dr. Deep Socket	101
60775	11 in. Small Hose Grip Pliers	34	62102	1/2 in. Dr. Flex Head Teardrop Ratchet	99	62421	21 mm 1/2 in. Dr. Deep Socket	101
60777	11 in. Medium Hose Grip Pliers	34	62106	1/2 in. Dr. Round Head Ratchet	99	62422	22 mm 1/2 in. Dr. Deep Socket	101
60778	11 in. Large Hose Grip Pliers	34	62120	18 in. 1/2 in. Dr. Breaker Bar	96	62423	23 mm 1/2 in. Dr. Deep Socket	101
60779	11 in. Flat Nose Pliers	34	62124	24 in. 1/2 in. Dr. Breaker Bar	96	62424	24 mm 1/2 in. Dr. Deep Socket	101
60780	11 in. Diagonal Cutting Pliers	34	62130	1/2 in. Dr. U-Joint	94	62425	25 mm 1/2 in. Dr. Deep Socket	101
60781	16 in. Long Nose Pliers	34	62140	3 pc. 1/2 in. Dr. Ext. Set	95	62426	26 mm 1/2 in. Dr. Deep Socket	101
60782	16 in. 45° Long Nose Pliers	34	62141	3 pc. 1/2 in. Dr. Wobble Ext. Set	95	62427	27 mm 1/2 in. Dr. Deep Socket	101
60783	16 in. 90° Long Nose Pliers	34	62143	3 in. 1/2 in. Dr. Ext.	95	62428	28 mm 1/2 in. Dr. Deep Socket	101
60810	T-10 Star Driver	33	62145	5 in. 1/2 in. Dr. Ext.	95	62429	29 mm 1/2 in. Dr. Deep Socket	101
60815	T-15 Star Driver	33	62150	10 in. 1/2 in. Dr. Ext.	95	62430	30 mm 1/2 in. Dr. Deep Socket	101
60820	T-20 Star Driver	33	62153	20 in. 1/2 in. Dr. Ext.	95	62432	32 mm 1/2 in. Dr. Deep Socket	101
60825	T-25 Star Driver	33	62157	1/2 in. Dr. F x 3/8 in. Dr. M Reducing Adapter	94	62500	9 pc. 1/2 in. Dr. SAE Socket Set	103
60827	T-27 Star Driver	33	62158	1/2 in. Dr. F x 3/4 in. Dr. M Increasing Adapter	94	62600	8 pc. 1/2 in. Dr. SAE 12 pt. Socket Set	104
60830	T-30 Star Driver	33	62160	5/8 in. 1/2 in. Dr. Spark Plug Socket	100	62616	1/2 in. 1/2 in. Dr. 12 pt. Deep Socket	102
60840	T-40 Star Driver	33	62161	5/8 in. x 10 in. Swivel Spark Plug Socket Ext.	91	62618	9/16 in. 1/2 in. Dr. 12 pt. Deep Socket	102
60847	T-47 Star Driver	33	62162	13/16 in. x 10 in Swivel Ext. Spark Plug Socket	91	62620	5/8 in. 1/2 in. Dr. 12 pt. Deep Socket	102
60890	R0 x 4 in. Square Drive Screwdriver	33	62163	13/16 in. 1/2 in. Dr. Spark Plug Socket	100	62622	11/16 in. 1/2 in. Dr. 12 pt. Deep Socket	102
60891	R1 x 4 in. Square Drive Screwdriver	33	62202	9 pc. 1/2 in. Dr. Metric Standard Socket Set	103	62624	3/4 in. 1/2 in. Dr. 12 pt. Deep Socket	102
60892	R2 x 4 in. Square Drive Screwdriver	33	62210	10 mm 1/2 in. Dr. 6 pt. Socket	100	62626	13/16 in. 1/2 in. Dr. 12 pt. Deep Socket	102
60893	R3 x 4 in. Square Drive Screwdriver	33	62211	11 mm 1/2 in. Dr. 6 pt. Socket	100	62628	7/8 in. 1/2 in. Dr. 12 pt. Deep Socket	102
60933	3 pc. U-Joint Set	77	62212	12 mm 1/2 in. Dr. 6 pt. Socket	100	62630	15/16 in. 1/2 in. Dr. 12 pt. Deep Socket	102
60934	4 pc. Socket Adapter Set	76	62213	13 mm 1/2 in. Dr. 6 pt. Socket	100	62632	1 in. 1/2 in. Dr. 12 pt. Deep Socket	102
60960	#0 x 3 in. Phillips Screwdriver	32	62214	14 mm 1/2 in. Dr. 6 pt. Socket	100	62634	1-1/16 in. 1/2 in. Dr. 12 pt. Deep Socket	102
60961	#1 x 3 in. Phillips Screwdriver	32	62215	15 mm 1/2 in. Dr. 6 pt. Socket	100	62636	1-1/8 in. 1/2 in. Dr. 12 pt. Deep Socket	102
60962	#1 x 6 in. Phillips Screwdriver	32	62216	16 mm 1/2 in. Dr. 6 pt. Socket	100	62638	1-3/16 in. 1/2 in. Dr. 12 pt. Deep Socket	102
60963	#2 x 4 in. Phillips Screwdriver	32	62217	17 mm 1/2 in. Dr. 6 pt. Socket	100	62640	1-1/4 in 1/2 in. Dr. 12 pt. Deep Socket	102
60964	#2 x 6 in. Phillips Screwdriver	32	62218	18 mm 1/2 in. Dr. 6 pt. Socket	100	62700	8 pc. 1/2 in. Dr. Metric 12spt Socket Set	104
60965	#2 x 8 in. Phillips Screwdriver	32	62219	19 mm 1/2 in. Dr. 6pt Socket	100	62710	10 mm 1/2 in. Dr. 12 pt. Deep Socket	102
60966	#2 x 22 in. Phillips Screwdriver	32	62220	20 mm 1/2 in. Dr. 6 pt. Socket	100	62711	11 mm 1/2 in. Dr. 12 pt. Deep Socket	102
60967	#2 x 2-1/2 in. Phillips Screwdriver	32	62221	21 mm 1/2 in. Dr. 6 pt. Socket	100	62712	12 mm 1/2 in. Dr. 12 pt. Deep Socket	102
60968	#3 x 6 in. Phillips Screwdriver	32	62222	22 mm 1/2 in. Dr. 6 pt. Socket	100	62713	13 mm 1/2 in. Dr. 12 pt. Deep Socket	102
60969	#4 x 8 in. Phillips Screwdriver	32	62223	23 mm 1/2 in. Dr. 6 pt. Socket	100	62714	14 mm 1/2 in. Dr. 12 pt. Deep Socket	102
60970	1/8 in. x 3 in. Slotted Screwdriver	32	62224	24 mm 1/2 in. Dr. 6 pt. Socket	100	62715	15 mm 1/2 in. Dr. 12 pt. Deep Socket	102
60971	#3 x 22 in. Phillips Screwdriver	32	62225	25 mm 1/2 in. Dr. 6 pt. Socket	100	62716	16 mm 1/2 in. Dr. 12 pt. Deep Socket	102
60983	3/8 in. x 12 in. Slotted Screwdriver	32	62226	26 mm 1/2 in. Dr. 6 pt. Socket	100	62717	17 mm 1/2 in. Dr. 12 pt. Deep Socket	102
60986	3/16 in. x 3 in. Slotted Screwdriver	32	62227	27 mm 1/2 in. Dr. 6 pt. Socket	100	62718	18 mm 1/2 in. Dr. 12 pt. Deep Socket	102
60987	3/16 in. x 6 in. Slotted Screwdriver	32	62228	28 mm 1/2 in. Dr. 6 pt. Socket	100	62719	19 mm 1/2 in. Dr. 12 pt. Deep Socket	102
60988	1/4 in. x 4 in. Slotted Screwdriver	32	62229	29 mm 1/2 in. Dr. 6 pt. Socket	100	62720	20 mm 1/2 in. Dr. 12 pt. Deep Socket	102
60989	1/4 in. x 6 in. Slotted Screwdriver	32	62230	30 mm 1/2 in. Dr. 6 pt. Socket	100	62721	21 mm 1/2 in. Dr. 12 pt. Deep Socket	102
60990	1/4 in. x 8 in. Slotted Screwdriver	32	62232	32 mm 1/2 in. Dr. 6 pt. Socket	100	62722	22 mm 1/2 in. Dr. 12 pt. Deep Socket	102
60991	5/16 in. x 6 in. Slotted Screwdriver	32	62300	8 pc. 1/2 in. Dr. SAE Deep Socket Set	104	62723	23 mm 1/2 in. Dr. 12p t Deep Socket	102
60992	3/8 in. x 8 in. Slotted Screwdriver	32	62316	1/2 in. 1/2 in. Dr. Deep Socket	101	62724	24 mm 1/2 in. Dr. 12 pt. Deep Socket	102
60993	3/8 in. x 10 in. Slotted Screwdriver	32	62318	9/16 in. 1/2 in. Dr. Deep Socket	101	62725	25 mm 1/2 in. Dr. 12 pt. Deep Socket	102
60994	1/4 in. x 1-1/2 in. Slotted Screwdriver	32	62320	5/8 in. 1/2 in. Dr. Deep Socket	101	62726	26 mm 1/2 in. Dr. 12 pt. Deep Socket	102
60995	5/16 in. x 8 in. Slotted Screwdriver	32	62322	11/16 in. 1/2 in. Dr. Deep Socket	101	62727	27 mm 1/2 in. Dr. 12 pt. Deep Socket	102
60997	5/16 in. x 22 in. Slotted Screwdriver	32	62324	3/4 in. 1/2 in. Dr. Deep Socket	101	62728	28 mm 1/2 in. Dr. 12 pt. Deep Socket	102
60998	3/8 in. x 22 in. Slotted Screwdriver	32	62326	13/16 in. 1/2 in. Dr. Deep Socket	101	62729	29 mm 1/2 in. Dr. 12 pt. Deep Socket	102
61105	5 pc. Screwdriver Set	31	62328	7/8 in. 1/2 in. Dr. Deep Socket	101	62730	30 mm 1/2 in. Dr. 12 pt. Deep Socket	102
62000	1/2 in. Dr. Socket Rail	224	62330	15/16 in. 1/2 in. Dr. Deep Socket	101	62732	32 mm 1/2 in. Dr. 12 pt. Deep Socket	102
62002	9 pc. 1/2 in. Dr. SAE Socket Set	103	62332	1 in. 1/2 in. Dr. Deep Socket	101	62800	9 pc. 1/2 in. Dr. Metric 12 pt. Socket Set	103
62012	3/8 in. 1/2 in. Dr. 6 pt. Socket	100	62334	1-1/16 in. 1/2 in. Dr. Deep Socket	101	62860	T60 Tamp. Resist. 1/2 in. Dr. Star Bit Skt.	108
62014	7/16 in. 1/2 in. Dr. 6 pt. Socket	100	62336	1-1/8 in. 1/2 in. Dr. Deep Socket	101	62960	T60 1/2 in. Dr. Star Bit Skt.	108
62016	1/2 in. x 1/2 in. Dr. 6 pt. Socket	100	62338	1-3/16 in. 1/2 in. Dr. Deep Socket	101	62970	T70 1/2 in. Dr. Star Bit Skt.	108
62018	9/16 in. 1/2 in. Dr. 6 pt. Socket	100	62340	1-1/4 in. 1/2 in. Dr. Deep Socket	101	63000	3 lb. Sledge Hammer	40
62020	5/8 in. 1/2 in. Dr. 6 pt. Socket	100	62400	8 pc. 1/2 in. Dr. Metric Deep Socket Set	104	63004	3 lb. Cross Pein Hammer	40
62022	11/16 in. 1/2 in Drive 6 pt. Socket	100	62410	10 mm 1/2 in. Dr. Deep Socket	101	63008	8 oz. Dead Blow Hammer	40

Part #	Description	Page #	Part #	Description	Page #	Part #	Description	Page #
63016	24 oz. Ball Pein Hammer	40	68022	11/16 in. 3/8 in. Dr. Standard Socket	89	68330	15/16 in. 3/8 in. Dr. 6 pt. Socket	90
63020	16 oz. Claw Hammer	40	68024	3/4 in. 3/8 in. Dr. Standard Socket	89	68332	1 in. 3/8 in. Dr. 6 pt. Socket	90
63024	32 oz. Ball Pein Hammer	40	68026	13/16 in. 3/8 in. Dr. 6 pt. Standard Socket	89	68402	10 pc. 3/8 in. Dr. Metric Deep Socket Set	92
63032	32 oz. Dead Blow Hammer	40	68028	7/8 in. 3/8 in. Dr. 6 pt. Standard Socket	89	68406	6 mm 3/8 in. Dr. Deep Socket	90
63040	3 lb. Brass Non-Sparking Hammer	40	68030	15/16 in. 3/8 in. Dr. 6 pt. Standard Socket	89	68407	7 mm 3/8 in. Dr. Deep Socket	90
63064	3 lb. Copper Non-Sparking Hammer	40	68032	1 in. 3/8 in. Dr. 6 pt. Standard Socket	89	68408	8 mm 3/8 in. Dr. Deep Socket	90
63116	16 oz. Dead Blow Hammer	40	68101	3/8 in. Dr. Teardrop Ratchet	84	68409	9 mm 3/8 in. Dr. Deep Socket	90
63124	24 oz. Dead Blow Hammer	40	68102	3/8 in. Dr. Teardrop Flex Ratchet	84	68410	10 mm 3/8 in. Dr. Deep Socket	90
63125	5 pc. Hammer Set	39	68107	3/8 in. Dr. Quick-Release Round Head Ratchet	84	68411	11 mm 3/8 in. Dr. Deep Socket	90
63126	5 pc. General Hammer Set	39	68112	3/8 in. Dr. Round Stubby Ratchet	86	68412	12 mm 3/8 in. Dr. Deep Socket	90
63136	6 pc. General Purpose Hammer Set	40	68118	3/8 in. Dr. x 10 in. Breaker Bar	87	68413	13 mm 3/8 in. Dr. Deep Socket	90
63144	4 pc. Dead Blow Hammer Set	39	68130	3/8 in. Dr. U Joint	87	68414	14 mm 3/8 in. Dr. Deep Socket	90
63216	2 lb. Brass Non-Sparking Hammer	40	68140	1-3/4 in. 3/8 in. Dr. Standard Ext.	88	68415	15 mm 3/8 in. Dr. Deep Socket	90
63217	16 oz. Rubber Mallet	40	68143	3 in. 3/8 in. Dr. Ext.	88	68416	16 mm 3/8 in. Dr. Deep Socket	90
63232	32 oz. Rubber Mallet	40	68146	6 in. 3/8 in. Dr. Ext.	88	68417	17 mm 3/8 in. Dr. Deep Socket	90
63233	2.5 lb. Stoning Hammer	40	68148	8 in. 3/8 in. Dr. Ext.	88	68418	18 mm 3/8 in. Dr. Deep Socket	90
63308	8 oz. Ball Pein Hammer	40	68150	10 in. 3/8 in. Dr. Ext.	88	68419	19 mm 3/8 in. Dr. Deep Socket	90
63312	12 oz. Ball Pein Hammer	40	68152	4 pc. 3/8 in. Dr. Ext. Set	88	68421	21 mm 3/8 in. Dr. Deep Socket	90
63316	16 oz. Ball Pein Hammer	40	68156	18 in. 3/8 in. Dr. Ext.	88	68422	22 mm 3/8 in. Deep 6 pt. Socket	90
64130	3/4 in. Dr. U-Joint	105	68157	3 pc. 3/8 in. Dr. Wobble Ext Set	88	68500	10 pc. 3/8 in. Dr. SAE 12 pt. Socket Set	93
64144	3/4 in. Dr. 4 in. Ext.	105	68158	3/8 in. Dr. F x 1/2 in. Dr. M Increasing Adapter	87	68600	10 pc. 3/8 in. Dr. 12 pt. Deep Socket Set	93
64148	3/4 in. Dr. 8 in. Ext.	105	68159	3/8 in. Dr. F x 1/4 in. Dr. M Reducing Adapter	87	68700	10 pc. 3/8 in. Dr. 12 pt. Deep Socket Set	93
64157	3/4 in. x 1/2 in. Dr. Reducing Adapter	105	68160	5/8 in. 3/8 in. Dr. Spark Plug Socket	89	68800	10 pc. 3/8 in. Dr. Metric 12 pt. Socket Set	93
64158	3/4 in. x 1 in. Dr. Increasing Adapter	105	68161	5/8 in. 3/8 in. Dr. Spark Plug Socket	90	68802	12 pc. Star Bit Socket Set	113
64159	1 in Dr. F x 3/4 in Dr. M Socket Adapter	105	68162	5/8 in. 3/8 in. Dr. Ext. Spark Plug Socket	90	68804	4 pc. Star Bit Socket Set	113
66000	1/4 in. Dr. Socket Rail	224	68163	3/4 in. 3/8 in. Dr. Spark Plug Socket	89	68840	T40 Tamp. Resist. 3/8in Drive Star Bit Skt.	108
66001	21 pc. 1/4 in. Dr. SAE Socket Set	81	68164	13/16 in. 3/8 in. Dr. Spark Plug Socket	89	68845	T45 Tamp. Resist. 3/8 in. Dr. Star Bit Skt.	108
66002	10 pc. SAE 1/4 in. Dr. Standard Socket Set	82	68165	13/16 in. 3/8 in. Dr. U-Joint Spark Plug Skt.	90	68847	T47 Tamp. Resist. 3/8 in. Dr. Star Bit Skt.	108
66101	1/4 in. Dr. Teardrop Ratchet	79	68166	14 mm 3/8 in. Dr. Spark Plug Socket	89	68850	T50 Tamp. Resist. 3/8 in. Dr. Star Bit Skt.	108
66113	1/4 in. Dr. Stubby Ratchet	81	68168	18 mm 3/8 in. Dr. Spark Plug Socket	89	68855	T55 Tamp. Resist. 3/8 in. Dr. Star Bit Skt.	108
66130	1/4 in. Dr. U-Joint	78	68170	9/16 in. 3/8 in. Dr. Spark Plug Socket	89	68870	8 pc. 3/8 in. Dr. SAE Hex Bit Socket Set	111
66142	2 in. 1/4 in. Dr. Ext.	78	68201	22 pc. 3/8 in. Dr. Metric Socket Set	91	68871	8 pc. 3/8 in. Dr. SAE Hex Bit Socket Set	111
66144	4 in. 1/4 in. Dr. Ext.	78	68202	10 pc. 3/8 in. Dr. Metric Standard Skt. Set	92	68890	8 pc. 3/8 in. Dr. Metric Hex Bit Socket Set	110
66146	6 in. 1/4 in. Dr. Ext.	78	68206	6 mm 3/8 in. Dr. Standard Socket	89	68891	8 pc. 3/8 in. Dr. Metric Hex Bit Socket Set	111
66156	3 pc. Socket Adapter Set	77	68207	7 mm 3/8 in. Dr. Standard Socket	89	68940	T40 3/8 in. Dr. Star Bit Skt.	108
66157	1/4 in. x 3/8 in. Dr. Increasing Adapter	78	68208	8 mm 3/8 in. Dr. Standard Socket	89	68945	T45 3/8 in. Dr. Star Bit Skt.	108
66201	21 pc. 1/4 in. Dr. Metric Socket Set	81	68209	9 mm 3/8 in. Dr. Standard Socket	89	68947	T47 3/8 in. Dr. Star Bit Skt.	108
66202	10 pc. Metric 1/4 in. Dr. Standard Skt. Set	82	68210	10 mm 3/8 in. Dr. Standard Socket	89	68950	T50 3/8 in. Dr. Star Bit Skt.	108
66300	10 pc. SAE 1/4 in. Dr. Deep Socket Set	82	68211	11 mm 3/8 in. Dr. Standard Socket	89	68955	T55 3/8 in. Dr. Star Bit Skt.	108
66400	10 pc. 1/4 in. Dr. Metric Deep Socket Set	82	68212	12 mm 3/8 in. Dr. Standard Socket	89	68955	T55 3/8 in. Dr. Star Bit Skt.	108
66810	T10 Tamp. Resist. 1/4 in. Dr. Star Bit Skt.	108	68213	13 mm 3/8 in. Dr. Standard Socket	89	81356	5/16 in. SAE Spline Drive Comb.	12
66815	T15 Tamp. Resist. 1/4 in. Dr. Star Bit Skt.	108	68214	14 mm 3/8 in. Dr. Standard Socket	89	81357	3/8 in. SAE Spline Drive Comb.	12
66820	T20 Tamp. Resist. 1/4 in. Dr. Star Bit Skt.	108	68215	15 mm 3/8 in. Dr. Standard Socket	89	81358	7/16 in. SAE Spline Drive Comb.	12
66825	T25 Tamp. Resist. 1/4 in. Dr. Star Bit Skt.	108	68216	16 mm 3/8 in. Dr. Standard Socket	89	81359	1/2 in. SAE Spline Drive Comb.	12
66827	T27 Tamp. Resist. 1/4 in. Dr. Star Bit Skt.	108	68217	17 mm 3/8 in. Dr. Standard Socket	89	81360	9/16 in. SAE Spline Drive Comb.	12
66830	T30 Tamp. Resist. 1/4 in. Dr. Star Bit Skt.	108	68218	18 mm 3/8 in. Dr. Standard Socket	89	81361	5/8 in. SAE Spline Drive Comb.	12
66910	T10 1/4 in. Dr. Star Bit Skt.	108	68219	19 mm 3/8 in. Dr. 6 pt. Standard Socket	89	81362	11/16 in. SAE Spline Drive Comb.	12
66915	T15 1/4 in. Dr. Star Bit Skt.	108	68220	20 mm 3/8 in. Dr. 6 pt. Standard Socket	89	81363	8 mm Metric Spline Drive Comb.	12
66920	T20 1/4 in. Dr. Star Bit Skt.	108	68221	21 mm 3/8 in. Dr. 6 pt. Standard Socket	89	81364	10 mm Metric Spline Drive Comb.	12
66925	T25 1/4 in. Dr. Star Bit Skt.	108	68222	22 mm 3/8 in. Dr. 6 pt. Standard Socket	89	81365	11 mm Metric Spline Drive Comb.	12
66927	T27 1/4 in. Dr. Star Bit Skt.	108	68300	10 pc. 3/8 in. Dr. SAE Deep Socket Set	92	81366	13 mm Metric Spline Drive Comb.	12
66930	T30 1/4 in. Dr. Star Bit Skt.	108	68308	1/4 in. 3/8 in. Dr. Deep Socket	90	81367	14 mm Metric Spline Drive Comb.	12
66940	3 pc. 1/4 in. Dr. Ext. Set	78	68310	5/16 in. 3/8 in. Dr. Deep Socket	90	81368	15 mm Metric Spline Drive Comb.	12
68000	3/8 in. Dr. Socket Rail	224	68312	3/8 in. 3/8 in. Dr. Deep Socket	90	81369	17 mm Metric Spline Drive Comb.	12
68001	21 pc. 3/8 in. Dr. SAE Socket Set	91	68314	7/16 in. 3/8 in. Dr. Deep Socket	90	97005	18 in. Bolt Cutter	38
68002	10 pc. 3/8 in. Dr. SAE Standard Socket Set	92	68316	1/2 in. 3/8 in. Dr. Deep Socket	90	98012	12 Slot Metric Easy Carry Wrench Rack	223
68008	1/4 in. 3/8 in. Dr. Standard Socket	89	68318	9/16 in. 3/8 in. Dr. Deep Socket	90	98013	13 Slot SAE Easy Carry Wrench Rack	223
68010	5/16 in. 3/8 in. Dr. Standard Socket	89	68320	5/8 in. 3/8 in. Dr. Deep Socket	90	98050	14 Slot SAE Wrench Set Pouch	223
68012	3/8 in. 3/8 in. Dr. Standard Socket	89	68322	11/16 in. 3/8 in. Dr. Deep Socket	90	98051	16pc. Metric Wrench Set Pouch	223
68014	7/16 in. 3/8 in. Dr. Standard Socket	89	68324	3/4 in. 3/8 in. Dr. Deep Socket	90	19000-17	1.7 mm Needle and Nozzle Set	167
68016	1/2 in. 3/8 in. Dr. Standard Socket	89	68326	13/16 in. 3/8 in. Dr. 6 pt. Socket	90	19000-20	2.0 mm Needle and Nozzle Set	167
68018	9/16 in. 3/8 in. Dr. Std Socket	89	68328	7/8 in. 3/8 in. Dr. 6 pt. Socket	90	19000-23	2.3 mm Needle and Nozzle Set	167
68020	5/8 in. 3/8 in. Dr. StandardSocket	89				19100-23	2.3 mm Needle and Nozzle Set	167

TITAN

PROFESSIONAL TOOLS

1-800-386-0191

Fax: 1-800-386-0196 Email: info@titan-us.com

Distributed by Star Asia-USA, L.L.C. P.O. Box 58399, Renton, WA 98058

© Copyright 2017 Star Asia-USA, L.L.C. All rights reserved. Information contained in this literature is intended for use by Titan and Star Asia-USA, L.L.C. customers only. Any other use is prohibited. Titan and Star Asia-USA, L.L.C. are not responsible for typographical errors. Pictures are intended for reference only - actual product may vary. In our ongoing effort to provide the best quality and cost effectiveness, upgrades and modifications may be made to our products subsequent to publication which consequently will not be reflected here. Please check with your sales representative for latest information when placing orders.

catalog version 1.0 - form: CAT2017

TITAN

