

DENT FIX EQUIPMENT



**Collision Repair Equipment and
Tools for Premier Body Shops**



Perseverance:



The above word means a continued effort to do or achieve something despite difficulties.

Well that about sums up lots of things for all of us. For myself, the last two years have caused me to be nostalgic as I reflect on my many years in this industry, could be my age too. Our family company, Dent Fix Corporation, was started by my father Max in 1979. Well, needless to say my brother Brian and I were drafted into the ranks in Junior High. We started filling boxes with stud pins for sale and typing serial numbers on warranty cards. Not the first work we did for a family business, that distinction is held from when we would clean our Dad's shop floor at G&M Motors on the weekends. Borax, brooms and a hose, who knew there is a right way and a wrong way to sweep.

I remember working my first trade show as a teenager. The California Auto Body Association would hold a show at the Disneyland Hotel. We would run a 10x10 booth on the cheap. Dad designed and built the booth, my brother I would help carry in the carpet and tools through the back door. Then came some NACE shows, that was big time, but we still carried in the carpet. You know how heavy carpet is? It is HEAVY, and through a major convention center no less. Oh by the way, this was sometimes done through the side door.

Trade shows throughout the country got easier over time. Carpet was rented, pop up booths purchased we brought it up a notch. I also started to notice I was seeing and talking with the same customers and fellow exhibitors. This is where the nostalgia comes in as the industry has turned over several times. The people you meet and work with are what make this all fun and get you through the tough times.

We have good crew to help us now. Things have gotten somewhat easier than those first years, but each day brings a new challenge. We have been through a lot and we are still here, so bring it on. We will persevere!

PS: My Dad is finally getting around to restoring his 58 Speedster. He got it when he was still a mechanic. So it has only been 45 years. Well, that is perseverance too.

All the best,

Erik Spitznagel



**Collision Repair Equipment &
Tools for Premier Body Shops**



FOLLOW US & POST !

@dentfixequipment



**DENT FIX EQUIPMENT
1611 W 135th ST
GARDENA CA 90249-2505**

Website: www.DentFix.com

Phone: (310) 349-1940

Fax: (310) 349-1191

Email: info@dentfix.com

YouTube: [/dentfixequipment](https://www.youtube.com/dentfixequipment)

























TikTok: [@dentfixequipment](https://www.tiktok.com/@dentfixequipment)

Instagram: [@dentfixequipment](https://www.instagram.com/dentfixequipment)

Facebook: [/dentfixequipment](https://www.facebook.com/dentfixequipment)

Twitter: [@dentfixequip](https://www.twitter.com/dentfixequipment)

TABLE OF CONTENTS

| | | | | |
|---|------------------------|---------|---|---|
|  | ALUMINUM REPAIR | PAGE 04 |  |  |
|  | STEEL REPAIR | PAGE 20 |  |  |
|  | PLASTIC REPAIR | PAGE 40 |  |  |
|  | REFINISHING | PAGE 50 |  |  |
|  | GPR + PDR | PAGE 56 |  |  |
|  | MEASUREMENT | PAGE 60 |  |  |
|  | DETAIL + SHOP | PAGE 64 |  |  |
|  | CONSUMABLES | PAGE 66 |  |  |

©2022 DENT FIX EQUIPMENT

Dent Fix Equipment name, Dent Fix Equipment logo, and DF Dot logo are property of Dent Fix Corporation. All rights reserved. Dent Fix trademarks and slogans are not be used unless specified in writing by Dent Fix Equipment .

NOTICE: Equipment and tools listed in this catalog are subject to change based on manufacturer's discretion. For an updated tool listing please call or visit our website www.dentfix.com





ALUSPOT

ALUMINUM REPAIR STATION

Simply the BEST

Since 2006, we have been perfecting the most capable aluminum stud welding repair station. THIS IS THE MOST COMPLETE UNIT !

The DF-900DX/E Aluspot Extended includes everything that the Ford Approved Aluspot (DF-900DX) has PLUS Aluminum-Head Hammer Set (DF-AH714), POM Nylon Dolly Set (DF-AB712), two more storage drawers, an in-cabinet electrical power strip, and a holster on the side of the cabinet to hang the heat gun. The most complete aluminum repair station on the market !

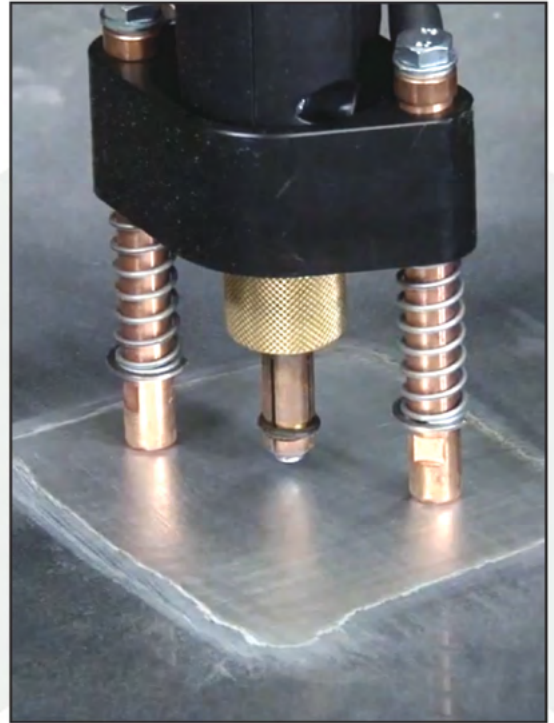

CONSUMABLES - See PG 9 & 66

INCLUDED (DF-900DX/E)

| | | | | | | |
|--|---|---|---|---|---|--|
|  DF-900W | 250 pc  DF-900PM | 250 pc  DF-900PS | 4 pc  DF-900PF |  DF-900TP |  DF-900SP |  DF-900LP |
|  DF-900BP |  DF-449SC |  DF-900HG |  DF-900PFH |  DF-900CPH |  DF-900RCH | |
|  DF-900SFH |  DF-900DBH |  DF-900BHND |  DF-900RHND |  DF-900DEND |  DF-900UTD |  DF-900TTD |
|  DF-900HLD |  DF-900CVD |  DF-700T |  DF-900SSB |  DF-AH714 | EVERYTHING IN THE DF-900DX PLUS: ALUMINUM HAMMERS, POM DOLLY SET POWER BANK, HEAT GUN HOLSTER, & MORE DRAWERS | |
|  DF-900DC |  DF-900BFB |  DF-900BFH |  DF-900SSBS |  DF-AB712 | | |

ALUSPOT ALUMINUM REPAIR STATION - DXE

Part No. DF-900DXE

Side cable opening allows for gun cable to hang away from the drawers



Satisfies the Panel Repair System Requirement for FORD & TESLA Body Shop Repair Programs

VOLTAGE

110v

DRAWERS

5

WEIGHT

280 lbs.

ALUSPOT

ALUMINUM REPAIR STATION

Proven Solutions

Since 2006, we have been meeting the needs for aluminum panel repair. FORD APPROVED!

The DF-900DX Aluspot Deluxe is the best selling aluminum repair station "from the name you know and trust." Here you have everything you need for aluminum repair, within easy reach in a self-contained system. The tools lock away so they do not wander the shop or become contaminated with the steel particles floating around the shop.



CONSUMABLES - See PG 9 & 66

INCLUDED (DF-900DX)

| | | | | | | |
|--|---|---|---|---|---|--|
|  DF-900W | 250 pc  DF-900PM | 250 pc  DF-900PS | 4 pc  DF-900PF |  DF-900TP |  DF-900SP |  DF-900LP |
|  DF-900BP |  DF-449SC |  DF-900HG |  DF-900PFH |  DF-900CPH |  DF-900RCH | |
|  DF-900SFH |  DF-900DBH |  DF-900BHND |  DF-900RHND |  DF-900DEND |  DF-900UTD |  DF-900TTD |
|  DF-900HLD |  DF-900CVD |  DF-700T |  DF-900SSB |  DF-900SSBS |  | |
|  DF-900BFH |  DF-900BFB |  DF-900DC | <p>SATISFIES THE PANEL REPAIR SYSTEM REQUIREMENT FOR FORD AND TESLA BODY SHOP REPAIR PROGRAMS</p> | | | |

ALUSPOT ALUMINUM REPAIR STATION - DX

Part No. DF-900DX



Side cable opening means drawers are not blocked by weld cable

WARRANTY
5
YEAR

Made In
USA

SATISFIES OEM
REQUIREMENT FOR
PANEL REPAIRS

VOLTAGE

110v

DRAWERS

3

WEIGHT

220 lbs.

ALUSPOT

ALUMINUM REPAIR STATION

Discover AluSpot

Experience the quality of a premium aluminum panel repair station without breaking the bank!

The **DF-900B AluSpot Mini** from Dent Fix Equipment is designed to operate as the main unit or as a satellite unit. The AluSpot Mini utilizes some of the same Dent Fix innovations and premier equipment as the larger AluSpot systems, but at a fraction of the price. Now any shop can invest in the future and start repairing minor to moderately damaged aluminum panels.

CONSUMABLES - See **PG 9 & 66**



Part No. DF-900B



Mini but Mighty

Any shop can invest in the future and start repairing minor to moderately damaged aluminum panels.

AluSpot Mini Pulling Upgrades



**AluSpot Bridge Puller
DF-900BP**



**AluSpot Squeeze Puller
DF-900SP**

ALUSPOT ALUMINUM REPAIR

STUD WELDER | PULLERS | SHAPING | CONSUMABLES

STOP REPLACING ALUMINUM PANELS - REPAIR THEM AND PROFIT INSTEAD



ALUSPOT Extended
DF-900DXE



ALUSPOT Deluxe
DF-900DX



ALUSPOT Mini
DF-900B



SIDE-BY-SIDE COMPARISON

| INCLUDED | DXE | DX | B |
|---------------------------------|-----|----|---|
| 110v Cap. Discharge Stud Welder | • | • | • |
| Alu-Silicon Studs | • | • | • |
| Alu-Magnesium Studs | • | • | • |
| Spitznagel Pull Fingers | • | • | • |
| T-Puller | • | • | • |
| Squeeze Puller | • | • | |
| Leverage Puller | • | • | • |
| Bridge Puller | • | • | |
| Stud Cut Pliers | • | • | • |
| Infrared Temp. Gauge | • | • | |
| Heat Gun | • | • | |
| 3 PC Hammers (Steel) | • | • | |
| 3 PC Hammers (Alumin.) | • | | |
| 2mm Soft Face | • | • | |
| 35mm Dead Blow Hammer | • | • | |
| 2 PC Nylon Chisels | • | • | |
| 12 PC Nylon Dollies | • | | |
| 3 PC Steel Dollies | • | • | |
| Heat Gun Holster | • | • | • |
| Shoe Handle Brush | • | • | • |
| Tooth Brush | • | • | • |
| Inline Pneumatic Paint Remover | • | • | |
| Fiber Discs | • | • | |
| Power Strip | • | • | • |
| 5 Year Warranty | • | • | • |
| Body File + 350mm Blade | • | • | |
| Safety Glasses | • | • | • |
| 5 Drawers | • | | |
| 3 Drawers | | • | |
| Dust Cover | • | • | • |

REPLACEMENTS



ALU-MAGNESIUM STUDS
M4x25 | 500 pc
DF-900PM/500



ALU-SILICON STUDS
M4x25 | 500 pc
DF-900PS/500



PULL FINGERS
1 PIECE
DF-900PF



FIBER DISCS
6 PIECE
DF-710BW



REPLACEMENT BLADE
1 PIECE
DF-900BFH

ALUMINUM HAMMER SET DF-AH714

- Solid aluminum head
- Avoid cross contamination
- Lightweight with more forgiving strike
- Less likely to stretch aluminum panel
- Maintenance free



PERFECT FOR ALUMINUM
AVOID GALVANIC CORROSION
GENUINE HICKORY HANDLES

NYLON DOLLIES DF-AB712

SOLID POM NYLON
NON-CORROSIVE



12
PIECE



- Non-Corrosive - Perfect for Aluminum Repair
- Non-Marking - When working with metal
- Molded Case - Tools kept organized & clean
- Maintenance free

TECH TIP:

HAMMER-ON VS HAMMER-OFF TECHNIQUE

When used properly, the two metal working techniques are very effective at repairing aluminum panels. The hammer-off dollying technique is used when first returning the dent to the original shape. Use the “first in, last out,” rule which means to work the dent in reverse, starting outside of the dent and working towards the point of impact. The tools best suited for hammer-off are highly polished steel hammers and rubberized steel core (DF-AB711). Aluminum can easily stretch, so use caution. Hammer-on is used by experienced technicians with lightweight aluminum hammers (DF-AH714) and Nylon dollies (DF-AB712) when smoothing the metal into its final position. Light tapping is used to finish.



RUBBERIZED DOLLIES

DF-AB711

**RUBBER SHELL
STEEL CORE**



**7
PIECE**

- Rubberized - Better for soft aluminum
- Steel Core - Dense center, good heft
- Case - Dollies are isolated & protected
- Maintenance free





RIVMAX

RIVETING REPAIR STATION

Riveting Repairs Made Easier

This riveting work station maintains all your riveting tools in this one mobile cabinet. Bring everything you need right to the work site. Keep your tools and rivets organized and secure in the foam inserts and lockable cart. The scissor top lid opens to a large work area and specially designed cradle to rest the SPR riveter when not in use.

This RIVMAX features our DF-SPR70 Ten Ton Riveter (pg.15). It also includes many of the optional accessories such as our Ford Die Set (pg. 16), Medium Sized Arm (pg. 16), Blind Rivet Adapter (pg. 17), and the Rivet Assortment Kit (pg. 18). This bundled version comes at a much better value than buying all the individual components separately.

CONSUMABLES - See PG 18, 19, & 66



- **All-in-one set up**

Complete tool set

- **Mobile**

All tools right at the work site

- **Organized**

A place for everything

- **Secure**

Lockable cart

Insert and Remove SPR Rivets + Pull Blind Rivets + Install Flow Form Rivets



Part No. DF-SPR70DX



Side cable opening means drawers are not blocked by the air hose

Kit Includes:

- Self-Piercing Riveter 10T
- Blind Rivet Adapter
- HR110 Arm
- HR210 Arm
- Universal Rivet Assortment Kit
- FORD Die Set
- Body Line Tool
- Lockable 3 Drawer Cabinet with Scissor Top Lid & Foam Cut-out Inserts

Optional Upgrades:

- HR310 Arm

SELF-PIERCING RIVETER 10T

Most Powerful Riveter

With 10 Tons of pressure punching through Boron Steel in order to install flow-form rivets is no problem at all.

The award-winning **Self-Piercing Riveter DF-SPR70** is part of most OEM recommended methods for joining aluminum panels together. The cold forming technique requires no heat and no pre-drilled holes. Manually adjust speed and rivet pressure for ultimate control to avoid panel distortion.



CONSUMABLES - See PG 18, 19, & 66

INCLUDED (DF-SPR70)

| | | | | | |
|--|--|--|---|--|--|
| <p>INCLUDED WITH DF-SPR70 Self-Piercing Riveter Kit</p> | <p>SPR • 3.3mm</p> <p>DF-SPR/AD</p> | <p>SPR • 5.3mm</p> <p>DF-SPR/BD</p> | <p>Extracting</p> <p>DF-SPR/ED</p> | <p>Hole Punch</p> <p>DF-SPR/TD</p> | <p>Flow Form</p> <p>DF-SPR/FD</p> |
| | <p>Flattening</p> <p>DF-SPR/D17</p> | <p>HR110 Arm</p> <p>DF-SPRHR110</p> | <p>SAMPLE RIVETS</p> | <p>O-Ring</p> <p>x4 DF-SPR/OR</p> | <p>Wrench</p> <p>DF-SPR/WD</p> |

TECH TIP:

WHAT IS A SELF-PIERCING RIVET?

Self-Piercing Riveting (SPR) is a cold forming technique used to join two panels together with no heat or pre-drilled holes needed to install. The self-piercing rivet pierces the top sheet and forms a mechanical interlock with the bottom sheet without penetrating the back panel.

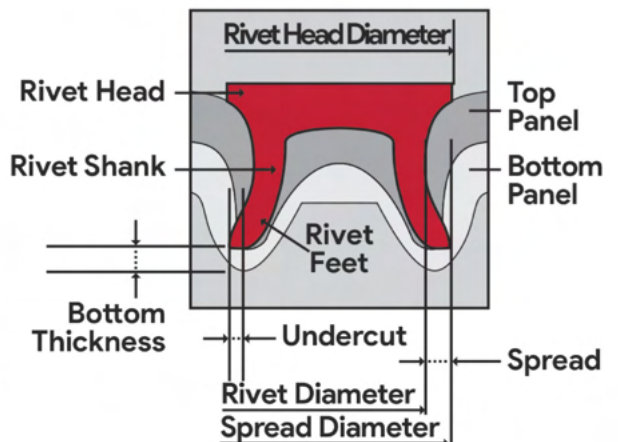

SELF -PIERCING RIVETER 10T

Part No. DF-SPR70



- Kit Includes:**
- Self-Piercing Riveter
 - HR110 Arm (DF-SPRHR110)
 - SPR Matrix Set 3mm (DF-SPR/AD)
 - SPR Matrix Set 5mm (DF-SPR/BD)
 - SPR Matrix Extracting Set (DF/SPR/ED)
 - Hole Punch Matrix Set (DF-SPR/TD)
 - Flow Form Matrix Set (DF-SPR/FD)
 - Sample Set of SPR rivets
 - Arm Locking Pin
 - Grip Handle & Shoulder Strap
 - Blow Molded Case

- Optional Upgrades:**
- Medium Arm (DF-SPRHR210)
 - Large Arm (DF-SPRHR310)

CLAMP WEIGHT 6.61 LBS
BODY WEIGHT 8.81 LBS



Inside the Case

| | | |
|---------------------------|------------------|-----------------|
| Operation | PSI* | Capacity |
| Pneumatic | 90 Min 110 Max | 8 Bar |
| Heads | Warranty | Readout |
| SPR, Extract, Flow, Punch | 1 Year | Dial Display |

* USE AIR REGULATOR

MEDIUM ARM
DF-SPRHR210



LARGE ARM
DF-SPRHR310



FORD DIE SET
DF-SPR/FORD70

- Rivet set for F-Series
- Fits DF-SPR70



DENT FIX EQUIPMENT

RIVET HOLDER DIE

SPR RIVETER DF-SPR70

B1 5.3 mm (DF-SPR/B)

HR3 ARM DF-SPRHR3

SCAN FOR VIDEO

DENT FIX EQUIPMENT

RECEIVING DIES

G1

G2

G3

G4

G5

G6

5.3x4.0 mm (DF-SPR54)

Riveter Settings:
7 bar @ 110 PSI regulated

Examples of SPR rivet insertion using the FORD die set

BLIND RIVET ADAPTER

DF-SPR/BRAD70

LONG NECK

- Minimal clearance needed
- Position into tight spaces
- 360° Head rotation
- Flexible at 90°



Blind Rivets

Need Consumables?
See Page 66

**NOTE: UNIT NEEDS D17
HEAD FROM RIVETER
TO OPERATE**



Fits
DF-SPR70



Position the adapter into tight spaces
such as under this hatch on a Tesla,
making removal unnecessary.



Storage for
blind rivet heads
3.2 | 3.6 | 4.0 | 4.5mm

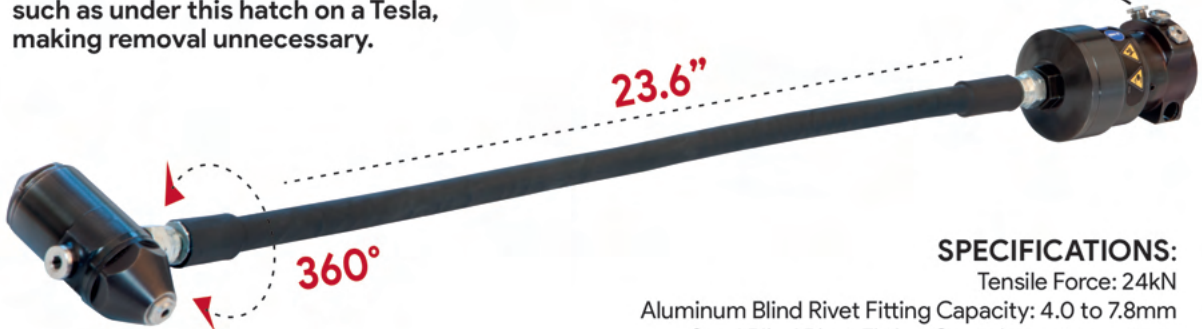

SPECIFICATIONS:

- Tensile Force: 24kN
- Aluminum Blind Rivet Fitting Capacity: 4.0 to 7.8mm
- Steel Blind Rivet Fitting Capacity: 4.0 to 6.4mm
- Fitting Capacity: Rivets RIBE
- Body Material: Steel
- Neck Flexible 90°
- Head Rotation: 360°

Universal Rivet Assortment

DF-URAK

- Self-Piercing Rivets
- Blind Rivets
- Plastic Rivets

The DF-URAK Universal Rivet Assortment Kit comes complete with all the necessary lengths of self-piercing rivets in the 3.35 millimeter and 5.3 millimeter diameter sizes. In addition to the wide variety of SPRs it also includes an assortment of **6 of the most popular nylon blind rivets** as well as **4 varieties of structural steel blind rivets** most popular in F-Series.

The inclusive assortment is a sampling size of all available SPR Rivet sizes. We also include the most commonly used Steel and Nylon Blind Rivets. The idea behind this configuration is to give the body shop a starting point of fasteners in one unit. As inventory is depleted the item part number is easily located on the inside box top.

When the shop does re-order, they will be getting the regular full packs. The assortment price reflects a 20% value add compared to buying all the fasteners individually.



Nylon Blind Rivet Sizes:

13/64" Diameter, 15/32" Flange,
15/64"-25/64" Grip Range

13/64" Diameter, 15/32" Flange,
1/8"-15/64" Grip Range

17/64" Diameter, 1/2" Flange,
3/32"-3/16" Grip Range

1/4" Diameter, 1/2" Flange,
5/32"-13/32" Grip Range

1/4" Diameter, 21/32" Flange,
5/32"-13/32" Grip Range

17/64" Diameter, 23/32" Flange,
3/32"-3/16" Grip Range

Self-Piercing Rivet Sizes:

3.35×3.5mm
3.35×4.0mm

3.35×5.0mm
3.35×6.0mm

5.3×4.0mm
5.3×5.0mm

5.3×6.0mm
5.3×6.5mm

5.3×7.0mm
5.3×7.5mm

5.3×8.0mm
5.3×9.0mm

5.3×10.0mm
5.3×12.0mm

Steel Blind Rivet Sizes:

1/4" Diameter, 1/2" Flange,
.060"- .138" Grip Range

1/4" Diameter, 1/2" Flange,
.110"- .189" Grip Range

1/4" Diameter, 1/2" Flange,
.189"- .238" Grip Range

1/4" Diameter, 1/2" Flange,
.268"- .346" Grip Range



SELF-PIERCING RIVETS

ZINC COATED

5.3mm Diameter*



5.3 x 4.0mm
(100 pc)
DF-SPR54



5.3 x 5.0mm
(100 pc)
DF-SPR55



5.3 x 6.0mm
(100 pc)
DF-SPR56



5.3 x 7.0mm
(100 pc)
DF-SPR57

5.3 x 6.5mm
(100 pc)
DF-SPR565

5.3 x 7.5mm
(100 pc)
DF-SPR575



5.3 x 8.0mm
(100 pc)
DF-SPR58



5.3 x 9.0mm
(100 pc)
DF-SPR59



5.3 x 10.0mm
(100 pc)
DF-SPR510



5.3 x 12.0mm
(100 pc)
DF-SPR512

3.3mm Diameter*



3.3 x 3.5mm
(200 pc)
DF-SPR33



3.3 x 4.0mm
(200 pc)
DF-SPR34



3.3 x 5.0mm
(200 pc)
DF-SPR35



3.3 x 6.0mm
(200 pc)
DF-SPR36

* Quantities shown are for re-order part numbers

THE MAXI

STEEL DENT PULLING STATION **DXE**

Most Advanced MAXI EVER!

Protect factory coatings with the best way to pull without damaging the panel: GPX PLUS the MAXI. From light to heavy pulls, The MAXI DXE does it all!

The DF-505/DXE MAXI Steel Dent Pulling Station includes our heavy duty Glue Puller Xtreme. This winning combination provides the technician with the ultimate dent pulling combination for all types of panel damage. Lower cycle times increase profit.

CONSUMABLES - See PG 22, 66, & 67



INCLUDED (DF-505/DXE)



Part No. DF-505/DXE



- Kit Includes:**
- 220V The Maxi
 - Lockable 5-Drawer Cart
 - 5-Piece Hammer Set
 - 6-Piece Dolly Set
 - Body File & Blade
 - Bridge Puller (DF-505BP)
 - Maxi Massager (DF-505DM)
 - 9-Finger Bear Claw (DF-506)
 - 4-Finger Bear Claw (DF-504)
 - Leverage Puller (DF-503L)
 - Magnetic Key Electrode (DF-503KEM)
 - Wiggle Wire | Thick & Thin
 - Weld Key | Twisted & Flat
 - Right Angle Undercoat Remover (DF-701)
 - Flexible Fender Puller (DF-HD0140)
 - Door Prop Stick (DF-DSP1)
 - Suction Gun (DF-SG70)
 - Ring Hammer (DF-903)
 - 5 pc Wedge Scrapper Set (DF-622)
 - Multi-Clip Pliers (DF-625)
 - Bodyline Marker Tool (DF-BL10A)
 - Clip Lifter (DF-618CL)
 - Surge Protector (DF-601A)
 - Safety Glasses (DF-901SG)
 - Glue Puller Xtreme (DF-GPX)
 - 9-Finger Bear Claw Bridge Attachment (DF-505BP/09)
 - GPX Leverage Puller (DF-900LP)

THE MAXI

STEEL DENT PULLING STATION

Game Changer

In 1999, The MAXI changed the way steel panels are repaired FOREVER.

The DF-505/220V MAXI Steel Dent Repair Station is 220 volt (also available in 110V) single phase steel dent pulling station that provides the technician with the power they need to shrink, pull rocker panels, hail damage, creases, and dents in hard to access areas and all types of metal damage. Just WELD > PULL > TWIST. Maximize your pulling and earning potential. This is a MONEY MAKER !

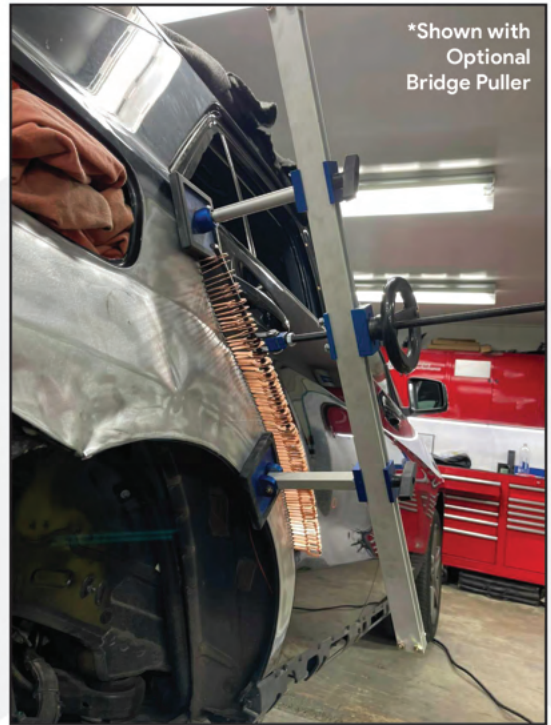









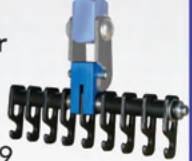

*Shown with Optional Bridge Puller

Photo Credit: @luxury.car.repair

CONSUMABLES - See Below & PG 66

| | | | | | | |
|---|---|--|---|--|--|--|
| Included with the DF-505/220v | Pulling Rods  5.5" | Slide Hammer Rods  10" | Strike Weight  DF-503SW | Leverage Puller  DF-505L | Stud Pin Electrode  DF-503P | Wiggle Wire Tip  DF-503W |
| 9 Finger Claw  DF-506 | 4 Finger Claw  DF-504 | Sample Weld Keys  | Wiggle Wire  | Grounding Magnet  DF-GM | Shrinking Electrode  DF-503S | Key Tip  DF-503KEM |

| | | | | |
|--|--|--|---|--|
| Optional Upgrades & Re-Orders | MAXI Bridge Puller DF-505BP  | | MAXI Massager  | |
| | Weld Ground  DF-WG1 | 9-Finger Bridge Puller Attachment  DF-505BP/09 | Flat Keys  100 pc DF-503KF | Twisted Keys  100 pc DF-503KT |
| Work Stand  DF-509 | Wheel Puller for Bridge  DF-505BP/01 | Thin Wire  1 lb DF-507 | Thin Wire  1 lb DF-507TK | 10" Weld Rods  DF-503L |
| | | | | 5.5" Weld Rods  DF-503 |

MAXI STEEL REPAIR STATION

Part No. DF-505/220V



*

*MAXI PICTURED WITH
OPTIONAL STAND (DF-509)
PURCHASED SEPARATELY

- Kit Includes:**
- 220v Maxi Unit
 - Leverage Puller
 - x2 Pulling Rods
 - x2 Slide Hammer Rods
 - Strike Weight
 - Shrinking Electrode
 - Stud Pin Electrode
 - Wiggle Wire Welding Tip
 - Magnetic Key Tip
 - Nine-Finger Bear Claw
 - Four-Finger Bear Claw
 - x50 Sample Stud Pins
 - 1/2 lb Thick Wiggle Wire
 - 1/2 lb Thin Wiggle Wire
 - Weld Ground

- Optional Upgrades:**
- Machine Stand (DF-509)
 - MAXI Massager (DF-505DM)
 - MAXI Bridge Puller (DF-505BP)

POWER CABLE

18 Feet

PHASE

Single

WELDING CABLE

9 Feet

STEEL BRIDGE PULLER DF-505BP

- Holds pulls in place
- Controlled crease pulling
- Locking wheel adjustment
- Simple one person operation

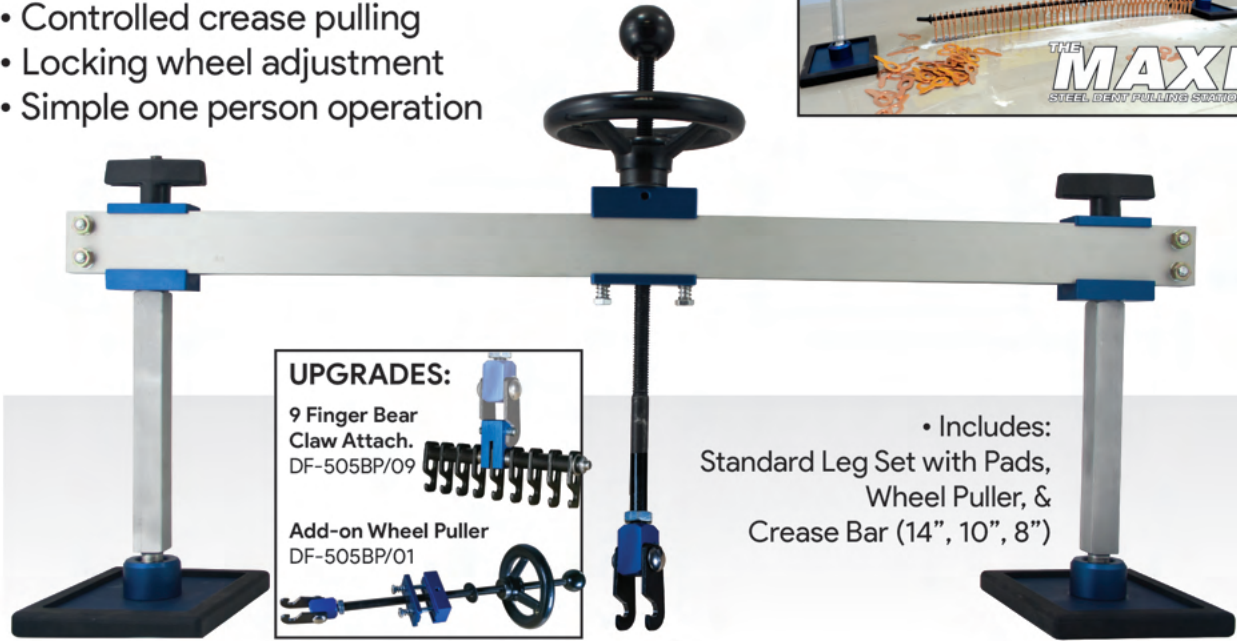

UPGRADES:

9 Finger Bear Claw Attach.
DF-505BP/09

Add-on Wheel Puller
DF-505BP/01

- Includes:
Standard Leg Set with Pads,
Wheel Puller, &
Crease Bar (14", 10", 8")

MAXI MASSAGER DF-505DM

MESSAGE STEEL PULLS



1
PIECE

- Adjustable depth
- Fine finish work
- Weld rod slides in easily

Uses DF-503 short
weld rod
(Not Included)





ACCESSORY TRAY DF-505AT

- Expand your storage
- Elevate your work space
- Keep tools off the ground
- Perfect factory fit
- Also fits the EZ Nitro



Includes one tray



MAXI DUST COVER DF-505DC

- Protect your MAXI
- Keep it clean
- MAXI stand not included, but needed for proper fit



Heavy Duty Construction with Thick, Water Resistant Vinyl



MAGNETIC KEY TIP DF-503KEM

- Weld keys with The MAXI
- For use with Bridge Pullers
- Includes key tip & sample keys



DF-503KF
Straight Weld Key
100 pcs



DF-503KT
Twisted Weld Key
100 pcs

The HAMMERHEAD

DF-595ii

110V



Kit Includes:
 Wiggle Wire Tip | Shrink Adapter
 1/2 lb Wiggle Wire | 4-Finger Claw
 Slide Hammer Rod & Weight | Short Pulling Rod
 Leverage Puller (DF-595iiLP) | Ground Magnet (DF-GM)

This efficient unit provides the technician with the means to higher productivity and better results. "It's like having sticky fingers and being able to pull the dent with your hand." The leverage puller allows for controlled pulls. The slide hammer gives you tapping action. Utilize the Wiggle Wire and Bear Claw to safely remove crease damage. Works with a 30 amp breaker. 1 year warranty.

| | | | | | | |
|--|--------------------------------------|--|-----------------------------|---|-------------------------------|--|
| <p>Included with the DF-595ii</p> | <p>Pulling Rods</p> <p>7"</p> | <p>Slide Hammer Rods</p> <p>11"</p> | <p>Strike Weight</p> | <p>Leverage Puller</p> <p>DF-595iiLP</p> | <p>4-Finger Claw</p> | |
| | <p>Grounding Magnet</p> | <p>1/2 lb Wiggle Wire</p> | <p>Tip Adapter</p> | <p>Shrinking Tip</p> | <p>Wiggle Wire Tip</p> | |

| | | | | |
|---------------------------------|-------------------------------------|--|------------------------------------|---------------------------------------|
| <p>Replacement Parts</p> | <p>Pull Rods 7" DF-503iiR</p> | <p>Slide Rods 11" DF-503iiLR</p> | <p>Wiggle Wire Thin DF-507</p> | <p>Wiggle Wire Thick DF-507TK</p> |
|---------------------------------|-------------------------------------|--|------------------------------------|---------------------------------------|

FLEXIBLE FENDER PULLER DF-HD0140

- Hinged hooks pivot
- Shapes to the curve of the fender
- Pulls up to 1.5 ton
- Great for pulling core supports

Tool adjusts to the shape of the fender



RING HAMMER DF-903

- 3 hammer heads in 1 tool
- Easy to use multi-tool
- Fits into tight spaces
- Solid hit from small tool
- Ultimate utility



DOOR PROP STICK DF-DPS1

- Secures a door, hatch, or hood in one position
- Three adjustments settings (11", 13", 15")
- Good for left or right use

3 ADJUSTMENT SETTINGS



WORKS GREAT FOR PDR



Spot Weld Bits for Chuck Drill



Variety Bits | DF-1786VP

Multi-faceted no slip shank. Variety pack of 5 bits with the hardest coating available! Titanium Carbo-Nitride (HSSE-TiCN) coated drill bits. Includes one 6mm, three 8mm, & one 10mm bit.



Titanium Nitride | DF-1780T

8x80mm Drill Bit

Specifically designed for the rigors of spot welding drilling. German-made bits can be used with any 3/8" drill. Centering nib prevents bit from walking

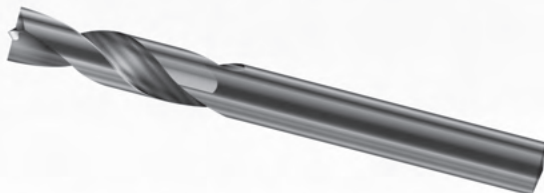

High Speed Cobalt | DF-1780

8x80mm Drill Bit

Specifically designed for the rigors of spot welding drilling. German-made bits can be used with any 3/8" drill. Centering nib prevents bit from walking

BORON



▲ DF-1690

8mmx45mm

Tungsten-Carbide

HARD EDGE



▲ DF-1680TC

8mmx45mm

Titanium Carbon Nitride

HARD EDGE



▲ DF-1610TC

10mmx45mm

Titanium Carbon Nitride

HEAT RESIST.



▲ DF-1680T

8mmx45mm

Titanium Nitride

HEAT RESIST.



▲ DF-1610T

10mmx45mm

Titanium Nitride

HSS



▲ DF-1465

6.5mmx45mm

High Speed Cobalt

HSS



▲ DF-1480

8mmx45mm

High Speed Cobalt

HSS

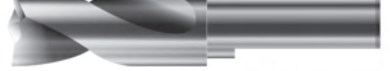

▲ DF-1610

10mmx45mm

High Speed Cobalt

Spot Annihilator

DF-15DX

- Depth Adjustable
- Smart Pressure Valve
- No Slamming
- Prevent bit breakage
- Boron steel capable
- Pneumatic cutting pressure



JUST AS FAST AS GRINDING

PLUS: Less Dust and Less Noise.



Optional Upgrades:

- 6" Mega C-Clamp (DF-SPD48M)
- Boron Killer 8mm Bit (DF-1690)
- HSS 6.5mm Bit (DF-1465)
- HSS 10mm Bit (DF-1610)
- Hard Edge 10mm Bit (DF-1610TC)
- Cup & Screw (DF-SPD66A)

Kit Includes:

- Spot Weld Drill (DF-15B)
- HSS 8mm Bit (DF-1480)
- Heat Resist. 8mm Bit (DF-1680T)
- Hard Edge 8mm Bit (DF-1680TC)
- Heat Resist. 10mm Bit (DF-1610T)
- Pneumatic Oil Kit
- Blow Molded Case

WARRANTY

1 YEAR

AIR PRESSURE

90 PSI

ROTATIONAL SPEED

1,000 RPM

SHUNTING PLIERS

DF-SP360

- Required by I-CAR for STRSW E-coated panels
- Shunts the current flow
- Thick copper wire and pads
- Ensure proper welds

4
GAUGE WIRE

SAVES THE E-COAT



MAX AMPERAGE

145 AMPS

COPPER WIRE

4 GAUGE

WARRANTY

90 DAYS

TECH TIP:

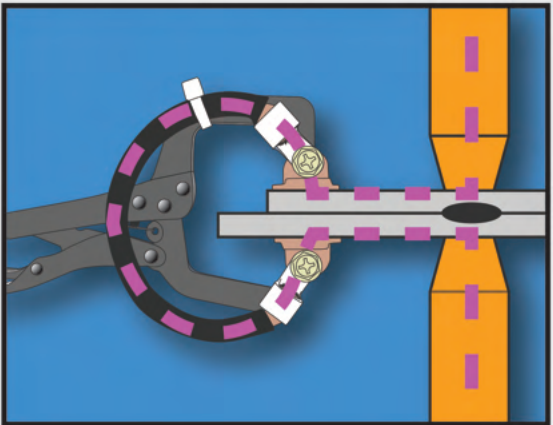

Why Use Shunting Pliers?

Squeeze-type resistance spot welding (STRSW) sometimes requires additional measures, in the form of shunting the current flow, to create a successful spot weld.

Conductive coatings on steel, such as zinc or weld-through primer increase the resistance but a successful weld can be accomplished. Non-conductive coatings on steel, such as E-Coat (a corrosion-resistant primer applied to parts by the manufacturer) inhibit the completion of the spot weld.

The E-Coat on the mating surfaces can be saved when using STRSW with the use of the Dent Fix Shunting Pliers (DF-SP360). Simply remove the coating from only the outside surfaces, position the shunting clamp at the spot weld site, and the spot weld is made at the adjacent site. The current chooses the path of least resistance when confronting the non-conductive E-Coat. The shunting pliers conduct the electrical current from one side to the other. The E-coat at the mating surface burns away. The process is very quick and despite the fact most of the current flows between the electrode tips the current detour was brief but necessary.

DOOR SKIN PLIERS DF-DSP310

- Holds the door skin securely in place
- Provides clamping without interrupting flange fold over

PERFECT FOR RE-SKINNING

2 Special Contact Pads
Adjustable to clamp onto different panel thicknesses



Inner contact bar spreads the force evenly

Outer pad prevents damage to outer panel



SURGE PROTECTOR DF-601A

- Protects electronics from surges
- For 12 & 24 volt systems
- Lifetime warranty
- Made in the USA
- DO NOT USE ON HYBRIDS

**12 • 24
VOLT SYSTEMS**

**LIFETIME
WARRANTY**



RIGHT ANGLE

DF-701

- Compact design
- Great for tight areas
- Remove thick seam sealer
- Undercoating can be removed
- Decal wheel & 3 coarse brushes



**ORIGINAL ERASER
WHEEL INCLUDED!**



ORIGINAL

DF-705 Decal Eraser

Softer

Will not burn the paint.
The perfect tool for
cleanup of moldings



If you don't have one you need one. With the Coarse brush, undercoating and seam sealer are stripped away easily and cleanly, right down to the bare metal. The brushes do not clog up. Remove rust and scale. The fine brush is perfect for getting paint out of tight spaces. The geared Decal Eraser will strip a 2 foot by 2 foot decal in less than 2 minutes with no paint burn. The eraser is ideal for removing the adhesive backing on moldings and badges. The tool carries a year warranty and our guarantee of complete satisfaction.



TOUGHER

DF-705D Offset Eraser

More Durable

Perfect for the removal of
large decals such as those
found on delivery vans.



DF-702C Coarse Brush

The flex allows the brushes
to compress in tight corners
and contour themselves
over the lipped edges and
curved corners. Makes fast
work of bed liner.

ELIMINATOR

INLINE UNDERCOAT AND DECAL REMOVER
DF-700DX

3,500
RPM

Pneumatic Operation



Kit Includes:

- Eliminator Tool (DF-700T)
- Original Decal Eraser (DF-705)
- Offset Decal Eraser (DF-705D)
- Fiber Discs (DF-710BW)
- Single Disc Hub (DF-710BHS)
- Double Disc Hub (DF-710DHS)
- Coarse Brush (DF-702C)
- Fine 23mm Brush (DF-702SF)
- 11mm Coarse (DF-702C11)
- Fine Brush (DF-702F11)
- 23mm Hub (DF-702H23)
- 11mm Hub (DF-702H11)
- Blow Molded Case

REQUIRED PRESSURE

90 PSI (6 bar)

AIR CONSUMPTION

4 CFM

FREE SPEED

3,500 RPM

AIR INLET

1/4" NPT

REQUIRED HOSE SIZE

3/8" ID (9.5mm)

TOOL WEIGHT

2.6 lbs. (1.2Kg)



LED LIGHT
DF-LED935

ELIMINATOR
DF-700DX

ALUSPOT MINI
DF-900B

ULTRA DING MASSAGER
DF-DM55UDX

EZ NITROGEN
PLASTIC WELDER
DF-EZN1G



PREMIER AUTO BODY
TOOLS & EQUIPMENT

Since 1979



ALUSPOT
DF-900DX

ALUSPOT
DF-900DX

ALUSPOT DELUXE
DF-900DX

ALUSPOT EXTENDED
DF-900DX/E

The MAXI
DF-505/220V

SELF-PIERCING
RIVETER
DF-SPR70

ALUMINUM
HAMMER SET
DF-AH714

Lucille



ANGLED FINGER SANDER DF-FBS20

- Guide keeps grinder in place
- Compact design
- Works best in tight areas
- Body rotates for access



LONG GRINDER DF-I9315CR

- Reach into corners to grind
- Extra long handle
- Shield rotates left and right
- Fits into tight work spaces
- 6.3 bar, 90 PSI

EXTRA LONG REACH

PRODUCT DIMENSIONS:

Tool Length: 16"
From the tip of the disc to the top of the handle: 10"
Width of the disc cover: 4.5"
Disc width: 4"
Neck width: 1.25"



CONSUMABLES

4" Grinding Wheel
1/8" x 3/8":
(DF-i9315GDB)

4" Cut-Off Wheel
110x1x10mm:
(DF-i9315CW)

AIR PRESSURE

90 PSI

WARRANTY

1 YEAR

MINI DIE GRINDER DF-DG5227

- Adjustable air speed
- Whisper quiet operation: 77 dB(A)
- Compact design fits perfectly into the hand
- Cushioned grip dampens vibration and allows for extended use



SPECIFICATIONS:
 Motor: Pneumatic
 PSI: 90 PSI
 Free Speed: 25,000 RPM
 Length: 6.3"
 Weight: 0.9 lbs

OPTIONAL CARBIDE BURRS



PANEL SAW DF-PS36

- Cuts up to 16 gauge
- Cut through top panel only
- Double grip handle for firm control
- Guide helps keep the line straight



SPECIFICATIONS:
 Motor: Pneumatic
 PSI: 90 PSI
 Horsepower: 3/4
 RPM: 1,000
 Max Panel Thickness: 16 Gauge

SET THE
DISTANCE
FROM THE
EDGE ▶



SLOT PLIERS DF-SP820

- Produces 8x20mm slot punch
- Ideal for MIG brazing
- Throat depth of 30mm
- Comfort grip
- Up to 18 gauge steel
- Online only at DentFix.com



8x20mm



ICAR MIG
BRAZING

JAGUAR
PROGRAM

PUNCH/FLANGE DF-516PF

- Punches 8mm holes
- Up to 18 gauge steel
- Swivel head for flanging
- Also available in 6.5mm holes (DF-316PF)



8mm



ANGLED

DIE

ALL HOLE PUNCH DIES ARE ANGLED FOR SHEARING EFFECT

8.0MM PUNCH DF-516

- Punches 8.0mm holes
- Up to 18 gauge steel
- Depth adjustable
- Long handle for power



8mm



QUALITY
TOOL

6.5MM PUNCH DF-8

- Punches 6.5mm holes
- Up to 18 gauge steel
- Deep throat
- Allows for more room from edge



6.5mm



TECHNICIAN
FAVORITE

PNEUMATIC PUNCH/FLANGE
DF-MP050K

- Punch & Flange Kit
- Pneumatic operation
- 4.0, 5.5, 6.5, 8.0mm Punches
- 8.0mm Deep Punch/Flange



**5 PUNCHES &
1 FLANGE
IN ONE CASE**



FLANGE WIDTH

1 INCH

WARRANTY

1 YEAR



EZ NITRO PLASTIC WELDER Generator

No More Tanks

Save Money! Convert shop air into nitrogen to run at a lower cost and more convenience than refilling tanks.

The award-winning DF-EZN1G EZ Nitro Plastic Welder's on-board nitrogen generator eliminates bulky nitrogen tanks, creating a smaller footprint. The proprietary Flow Adjust Switch Technology (FAST) System makes the DF-EZN1G the easiest nitrogen welder to set-up, adjust, and use.

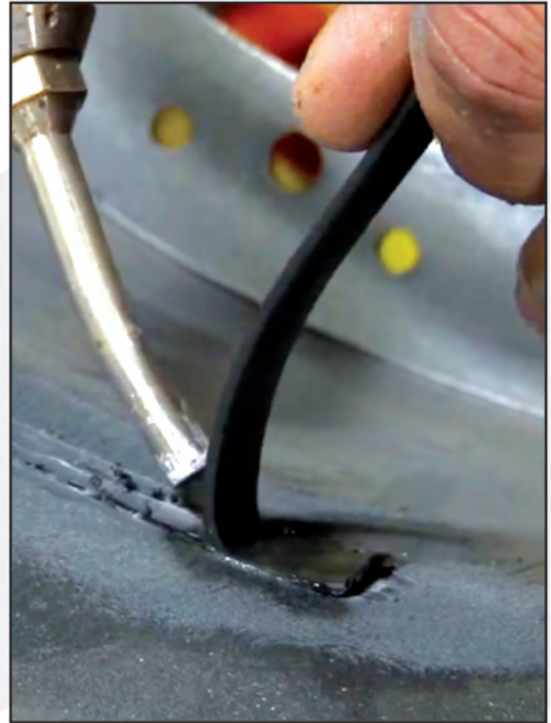

CONSUMABLES - See Below & PG 67

| | | | | | | |
|--|-----------------------------|-------------------------|-----------------------------------|----------------------|---------------------|---------------------------------|
| Included with DF-EZN1G EZ Nitrogen Plastic Welder Generator | Nitrogen Welder | Storage Cart | Plastic Rod Assortment | Generator | Heat Gun | OPTIONAL EQUIPMENT |
| Aluminum Tape | Heat Gun Holster | Hand Seamer | | | | Hot Stapler DF-800BR |
| DF-EZN1-AT150 | DF-900HGH | DF-EZN1HS | | | DF-900HG | |

| EZ NITRO PLASTIC WELDER 25 Piece Pack | POLYETHYLENE PE, LDPE, HDPE, PPE | POLYPROPYLENE PP, PP/EPDM, PP/T20, TPO, TEO, TSOP | POLYCARBONATE PC, PC + ABS, PC + PBT |
|---|--|---|--|
| ABS ABS, ABS + PC, ABS + PA | 3mm • Round DF-PEBK03 9mm • Flat DF-PEBK09 15mm • Flat DF-PEBK15 | 3mm • Triangle DF-PPBK03T 3mm • Round DF-PPBK03 6mm • Flat DF-PPBK06 9mm • Flat DF-PPBK09 15mm • Flat DF-PPBK15 | 3mm • Triangle DF-PCNT03T 3mm • Round DF-PCNT03 6mm • Flat DF-PCNT06 9mm • Flat DF-PCNT09 |
| 3mm • Triangle DF-ABBK03T 3mm • Round DF-ABBK03 9mm • Flat DF-ABBK09 15mm • Flat DF-ABBK15 | POLYURETHANE PU, PUR, PRIM, RIM, TPU, TPUR 3mm • Round DF-PUNT03 | | |



EZ NITRO PLASTIC WELDER GENERATOR

Part No. DF-EZN1G

EZ NITRO
PLASTIC WELDER
Generator



High Pressure Nitrogen Outlet can run air tools.



Converts shop air into nitrogen to run the plastic welder



- Kit Includes:**
- EZ Nitrogen Welder Unit
 - Air Welder
 - Rolling Storage Stand
 - N2 Generator
 - Power Strip on the cart
 - Hand Seaming Tool - 3.5"
 - Aluminum Tape Roll - 150ft
 - Heat Gun Holster
 - Plastic Sample Pack
 - ABS
 - Polycarbonate
 - Polyethylene
 - Polypropylene
 - Polyurethane

Also Available
Bottle-Fed
Unit

80
CUFT
MAX



DF-EZN1

NITROGEN PRESSURE

20 PSI

AIR PRESSURE

20 PSI

POWER

110v

EZ NITRO PLASTIC REPAIR STATION

Ditch the Bottle

Save yourself from refilling nitrogen bottles!
Convert shop air into N2 instead of paying for refills.

The DF-EZN1G/DXE EZ Nitro Deluxe Station is the most comprehensive plastic work station available. All the tools needed are bundled in one tight package. From grinders to hot staplers, everything is included to help you profit from the repair of expensive plastic parts. Improve shop efficiency by turning light hit vehicles faster. On board nitrogen generation just makes this a sweeter deal !



CONSUMABLES - See PG 40 & 67



Part No. DF-EZN1G/DXE



Ditch the bottle.
Save yourself from refilling nitrogen bottles! Convert shop air into N2 instead of paying for refills.

Reduce Safety Issues



N2 Shield.
High pressure nitrogen outlet equipped with a moisture filter, that helps shield air-powered tools against dirty shop air.

Capable of filling up tires!



COMPARE EZ NITRO STATIONS

GAS WELD | AIRLESS WELD | HOT STAPLER | GENERATOR

STOP THROWING AWAY BUMPER COVERS - REPAIR THEM INSTEAD OF REPLACE



EZ BOTTLE FED DF-EZN1

- EZ Nitro Plastic Welder*
- Airless Plastic Welder
- Heat Gun (DF-900HG)
- Heat Gun Holster
- Aluminum Tape (DF-EZN1-AT150)
- Tank Reglator
- Tank Brackets
- Plastic Welding Rods:
 - ABS, Polypropylene,
 - Polycarbonate, Polyethylene, &
 - Polyurethane

* Nitrogen Tank not included, needs to be locally sourced.

UPGRADE ANY BRAND PLASTIC WELDER WITH THE DF-EZN1G N2 Generator (Pg 44)



EZ NITRO G DF-EZN1G

- Nitrogen Generator
- EZ Nitro Plastic Welder
- Airless Plastic Welder
- Heat Gun (DF-900HG)
- Heat Gun Holster
- Aluminum Tape (DF-EZN1-AT150)
- Plastic Welding Rods:
 - ABS, Polypropylene,
 - Polycarbonate, Polyethylene, &
 - Polyurethane



EXTENDED DXE DF-EZN1G/DXE

- Nitrogen Generator
- EZ Nitro Plastic Welder
- Airless Plastic Welder
- Hot Stapler Kit (DF-800BR)
- Mini Die Grinders (DF-DG5227)
- Heat Gun (DF-900HG)
- Double End Nylon Dolly (DF-900DEND)
- Round Head Nylon Chisel (DF-900RHND)
- Aluminum Tape (DF-EZN1-AT150)
- Multi-Clip Pliers (DF-625)
- Plastic Clip Pliers (DF-624CP)
- Clip Lifter (DF-618CL)
- Hand Seamer (DF-EZN1HS)
- Ring Hammer (DF-903)
- Dust Cover
- Utility Wedge Set (DF-609)
- Plastic Lever Scraper (DF-WK20)
- Plastic Welding Rods:
 - ABS, Polypropylene,
 - Polycarbonate, Polyethylene, &
 - Polyurethane

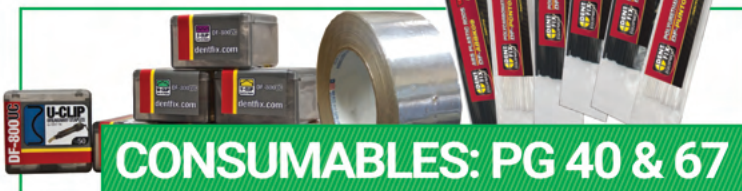

CONSUMABLES: PG 40 & 67

UPGRADE YOUR BOTTLE-FED
PLASTIC WELDER!

EZ NITRO GENERATOR

DF-EZG1

Upgrade any brand of Plastic Welder with the EZ Nitro Generator and "DITCH THE BOTTLE," Never Run out of Nitrogen AGAIN!

Dent Fix's revolutionary Dual Chamber Separating System transforms your compressed shop air into an endless supply of both regulated & high-pressure nitrogen.

BONUS: You can also fill your customer's tires with beneficial nitrogen and/or safeguard the internals of your pneumatic tools by powering them with nitrogen from the EZ Nitro Generator!

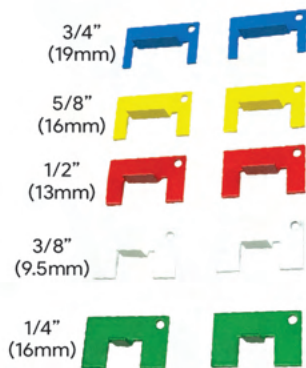

AIRLESS WELDER

DF-EZA1

Simply plug into a 110V socket and begin welding damaged plastic parts back together! Adjustable heat setting for multiple plastic types. Includes plastic welding rod samples (ABS, Polypropylene, Polyethylene, Polycarbonate, and Polyurethane), smoothing tip, and feeder tip.

EZ TAB REPAIR KIT

DF-EZTAB

Assists in performing fast, strong slot tab repairs on plastic parts. 5 different sized slot dies, ranging in size from 1/4" (6mm) to 3/4" (19mm). The included hand seamer is used to compress the tab after welding.

Replacement Tabs: 10pc Variety (DF-EZTABS), 3/4" (DF-EZTABB), 5/8" (DF-EZTABY), 1/2" (DF-EZTABR), 3/8" (DF-EZTABW), 1/4" (DF-EZTABG)



SWIVEL RIVETER DF-CT888



- Ultimate access for rivet placement
- 360° Rotational head
- Includes 5.0 & 6.3mm rivets



CONSUMABLES
PLASTIC RIVETS

5.0mm (50 pc) DF-CT887RS
6.3mm (50 pc) DF-CT887RL

SLIMLINE RIVETER DF-CT887



- Access the tightest places
- 2" Gap clearance
- Works around wheel arches
- Includes 5.0 & 6.3mm rivets



CONSUMABLES
PLASTIC RIVETS

5.0mm (50 pc) DF-CT887RS
6.3mm (50 pc) DF-CT887RL



BLOW MOLDED
CASE INCLUDED

NYLON POP RIVET ASSORTMENT DF-NRAK

- Most popular rivets
- Clearly marked and organized
- Tackle box style case



*Sizes can be
found on DentFix.com



HOT STAPLER DELUXE

DF-800BR

THE ORIGINAL HOT STAPLER MADE IN AMERICA

- Installs staples to repair tears in plastic
- Saves thermoplastic parts from the trash
- Crafted to be compact & lightweight
- No base station

VOLTAGE

110v

WEIGHT

2 lbs

WARRANTY

5 YEARS



Kit Includes:

- Hot Stapler Deluxe
- Finishing Iron (DF-800SI)
- x50 U-Clip (DF-800UC/50)
- x50 S-Clip (DF-800SC/50)
- x50 V-Clip (DF-800VC/50)
- x50 M-Clip (DF-800MC/50)
- x50 Z-Clip (DF-800ZC/50)
- x50 W-Clip (DF-800WC/50)
- x50 N-Clip (DF-800NC/50)
- Blow Molding Case

HOT STAPLES / PATCH MESH



DF-800WC/50 (50 pc)
DF-800WC/250 (250 pc)



DF-800ZC/50 (50 pc)
DF-800ZC/250 (250 pc)



DF-800MC/50 (50 pc)
DF-800MC/250 (250 pc)

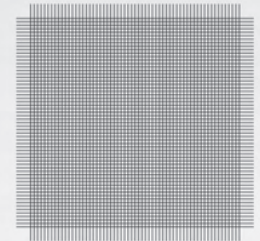

Patch Mesh
DF-800PM



DF-800NC/50 (50 pc)
DF-800NC/250 (250 pc)



DF-800SC/50 (50 pc)
DF-800SC/250 (250 pc)



DF-800UC/50 (50 pc)
DF-800UC/250 (250 pc)



DF-800VC/50 (50 pc)
DF-800VC/250 (250 pc)



LI-ION BATTERY HOT STAPLER DF-600BR

Three functions in one

- Install hot staples, airless weld plastic, and smoothing iron.
- Handheld unit is small in stature but very capable in tight spaces
- Foam inserts included with the case



Kit Includes:

Main Unit, Hot Stapler Head, Iron Head, Air Welder Head, Plastic Rod Samples, Staple Samples, Patch Mesh, and hard case



**3 TOOLS
IN ONE**

**RECHARGEABLE
BATTERY**

HOT STAPLER BASIC DF-400BR



Kit Includes:

Hot Stapler
x50 S-Clip StapleClips (DF-800SC/50)
x50 V-Clip StapleClips (DF-800VC/50)
x50 M-Clip StapleClips (DF-800MC/50)
x50 Z-Clip StapleClips (DF-800ZC/50)

**VALUABLE
TOOL**

**110V
VOLT**

- Installs staples to repair tears in plastic
- Saves thermoplastic parts from the trash
- 3 heat settings: Light Duty, Regular, HD
- Handle + base station

VOLTAGE

110v

WEIGHT

6 lbs

MADE IN

TAIWAN

WARRANTY

1 YEAR

MULTI-CLIP PLIERS

DF-625

Multiple tools in the palm of your hand

- Remove, pry, or cut tabs
- Disassemble trim clips
- Also cuts tubing or zip ties

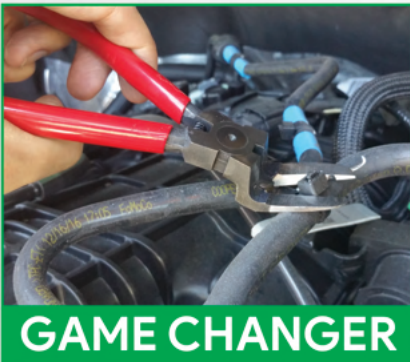

5 PC DOOR WEDGE SET

DF-622

- Utility wedge set
- Great for molding removal, popping clips, scraping, and wedging



WEDGE LIFTER

DF-WK20

- Perfect for glass, weather stripping, and interior plastics



3PC CLIP SET DF-618XL

- Removes fasteners & clips
- Great for upholstery removal
- Disassemble door panels
- 245x11, 370x11, 250x5mm

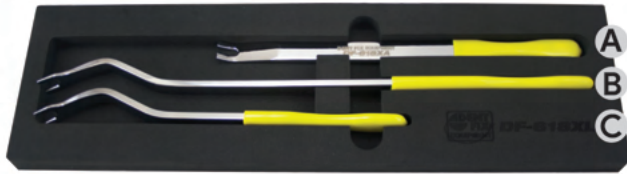

ALSO AVAILABLE INDIVIDUALLY

- A** DF-618XA | 250mm x 5mm
- B** DF-618XB | 370mm x 11mm
- C** DF-618XC | 245mm x 11mm

5PC CLIP KIT DF-618LK

- For plastic fasteners & clips
- Used for upholstery removal
- Door panel removal
- Angled & curved for leveraging



- K** DF-618CK | S-Clip Lifter
- N** DF-618CN | Clip Lifter
- L** DF-618CL | 7mm Clip Lifter
- M** DF-618CM | 5mm Half-Round Clip Lifter
- J** DF-618CJ | 11mm Angled Clip Lifter

COMBI WEDGE DF-619

- Wedge plus clip removal tool
- For dash & door panel removal
- Hard to lose, hi-vis yellow
- Constructed of strong plastic
- Pivot point for prying
- Length: 8.5"



2 TOOLS
IN-ONE

WEDGE + CLIP
REMOVER

HEAVY DUTY SCISSORS DF-HDSC1 & DF-HDS1

- Micro Teeth provide precise cutting of plastic, leather, cloth, rubber, gaskets, wire and other automotive materials.



DF-HDSC1
185mm

DF-HDS1
200mm



REFINISHING



CURE RIGHT UV GUN

FAST Curing Times

Take advantage of faster production times by using UV curable fillers and primers. As little as 1 second curing time for some UV primers. Automatic timer makes curing effortless.

The **CureRight UV Curing Lamp** is a fast curing solution when working with UV primers. Unique features like Ultra Sonic Range Finder help the tech maintain proper distance from the curing area. Equipped with an Active Cooling System to maintain optimum light output.

UV Paint Cups - See PG 51 & 54



Ultra Sonic Range Finder

Find the optimal distance for UV curing. (4-400cm, ± 3cm)



Wall Mounted Charging Station



KIT INCLUDES:

- UV-A Curing Light
- UV-A Protection Eye Glasses
- 15V1.5A Universal Charger + Adapter
- Wall-Mounted Charging Station
- Premium Foam Lined Protective Case



Part No. DF-CR004



UV
High Powered
LED 66W



395
 λ_p Wavelength
 ± 5 nm



400^{cm}
Ultra Sonic
Range Finder

SPECIFICATIONS:

Light Source: High Power UV LED
 LED Light Wattage: 66 Watts
 LED Lifetime: 40,000 Hours
 LED Wavelength: $\lambda_p = 395 \pm 5$ nm
 Battery Type: Li-ion 11.1V - 5200mAh, 57.72Wh
 Battery Charging Time: 3 Hours
 Battery Charging Info: AC 100 - 240V ~ 15V 1.5A
 Running Time: 90 Min. Total (Max 10 min. per use)
 Weight: 2 Lbs (0.9 Kg)
 Dimensions: 6-1/4" x 8-3/4" x 3"
 Housing Material: Aluminum + Polyamide
 Cooling System: Thermal Management System enhanced with cooling fan
 Ultrasonic Range Finder: Max 160" (400cm)
 Temp. Control Function: Working $\leq 194^\circ$ F (90° C)
 Safety Protection Function: Double click ≤ 100 ms
 Curing Distance: 2" to 8"
 Curing Zone Dimensions: 4" x 4" to 8" x 8"
 Curing Time: 5~12 seconds* to 30~80 seconds*

▶ ALSO AVAILABLE ◀

MMX UV
Measure/Mix



- Paint cups designed for applying UV primer
- Disposable cups and lids for speedy clean up.

MMXA400/24UV - 13.5oz | 125mic | 24pc
 MMXA650/24UV - 22.0oz | 125mic | 24pc
 MMXB400/24UV - 13.5oz | 190mic | 24pc
 MMXB650/24UV - 22.0oz | 190mic | 24pc

*This is laboratory data only for reference. The curing time may vary according to the paint product type, working conditions, the curing process and/or other factors.



MatchGUN DF-MR007

The MatchRight MatchGUN 5 Color LED Gun Lamp is a premium, super bright, rechargeable flood lamp that fits in the palm of your hand or mounts to the included tripod.

The high CRI (96+) lamp is the perfect light solution for producing the right lighting conditions while paint color matching and detailing.

The UV mode is a great solution for quick leak detection and light curing jobs.



2,400
LUMENS

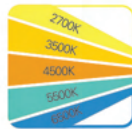

5
LIGHT
COLORS

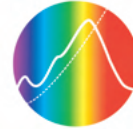

96+
CRI



SUPER BRIGHT:

Adjustable brightness levels from 300 Lumens all the way up to 2400 Lumens



VISUALIZE TRUE COLOR:

Wide CCT Range from 2700K to 6500K and a high CRI of 96+



KIT INCLUDES:

5 Color Color Match Light, Foam Lined Protective Case, Tripod, & Wall Mount Charger

MatchWAND DF-MR005

- Handheld color matching lamp
- Bench top charging dock with USB
- Magnets on the base and back of the unit
- Hook mount that folds away



500
LUMENS



3
LIGHT
COLORS



Replaceable
Lens



Magnet on
Back & Bottom



MatchHEAD DF-MR003

- Compact & Bright
- Versatile Light
- Adjustable Headband



160
LUMENS



Motion
Sensor
ON/OFF



3
LIGHT
COLORS



60°
Adjustable
Bracket

MAGNETIC PAINT CLAMP DF-PC203

- Strong & fast way to secure parts
- For a controlled spray painting/coating
- Magnetic base & powerful wedge grip



SUSPENDS THE
OBJECT

MAGNETIC
BASE



Measure/Mix MMX DF-MMX



A disposable paint cup lining system that is designed with time savings features and benefits. Mix your paint or primer directly in the cup with the help of measurement marks printed on the outside of the cup.

CUP SIZES | Choose between size, filter, and amount

MMXA90/50 - 3.0oz | 125mic | 50pc

MMXB90/50 - 3.0oz | 190mic | 50pc

MMXA180/50 - 6.0oz | 125mic | 50pc

MMXB180/50 - 6.0oz | 190mic | 50pc

MMXA400/24 - 13.5oz | 125mic | 24pc

MMXB400/24 - 13.5oz | 190mic | 24pc

MMXA400/50 - 13.5oz | 125mic | 50pc

MMXB400/50 - 13.5oz | 190mic | 50pc

MMXA650/24 - 22.0oz | 125mic | 24pc

MMXB650/24 - 22.0oz | 190mic | 24pc

MMXA650/50 - 22.0oz | 125mic | 50pc

MMXB650/50 - 22.0oz | 190mic | 50pc

MMXA850/24 - 29.0oz | 125mic | 24pc

MMXB850/24 - 29.0oz | 190mic | 24pc

MMXA850/50 - 29.0oz | 125mic | 50pc

MMXB850/50 - 29.0oz | 190mic | 50pc

Adapters | Visit www.dentfix.com for Spray Gun Application - Adapter NOT included with MMX Paint Cups



MMXAS/01 MMXAS/02 MMXAS/03 MMXAS/04 MMXAS/09 MMXAS/10 MMXAS/11 MMXAS/12 MMXAS/14 MMXAS/15



Measure/Mix

- Disposable paint cup system
- Paint cups designed for applying UV primer

MMXA400/24UV - 13.5oz | 125mic | 24pc

MMXA650/24UV - 22.0oz | 125mic | 24pc

MMXB400/24UV - 13.5oz | 190mic | 24pc

MMXB650/24UV - 22.0oz | 190mic | 24pc



Cap Stand - Invert the MMX cup system, when not in use, to keep the filter moist.

Security Ring - Keeps everything in place.

Filtered Lid - Select the option of 125 or 190mic

Darkened Liner - Blocks any ambient light from curing the primer while in the paint cup system.

Reusable Cup - No need to clean just replace the liner



STATIC ZAP

STATIC ELIMINATION TOOL



STATICZAP DF-EZAP

- Neutralizes static charge
- Eliminates dust attraction
- Metallic flake will stand up and sparkle
- Easy to use, just hook up to air hose and go
- Lithium ion battery powered

The StaticZap incorporates the efficiency and power of an air amplifier with the proven technology of corona ionization to produce a highly effective anti-static blow-off gun.

Perform the anti-static blow off before starting and at every stage in the painting process to produce a finish that looks like glass. Using this tool cuts down the time needed for wet sanding and buffing, saving labor on post work.

REPLACEMENT PARTS:

- Emitter Pins (5 pc) | DF-ZAP01
- Filter Kit (1 pc) | DF-ZAP02
- Battery Charger | DF-ZAP03
- Battery | DF-ZAP04



**NEUTRALIZE THE STATIC
CHARGE ELIMINATING
DUST ATTRACTION**

**GREAT FOR
WINDOW TINTING
& VEHICLE WRAPS**

**CORONA
IONIZATION
TECHNOLOGY**

- Kit includes:**
- Lightweight Durable Gun
 - Rechargeable Lithium Ion Battery
 - Two Emitter Pins
 - Safety Keys
 - Storage Case



XTREME UPGRADES

BRIDGE GLUE PULLER DF-505BP

- Holds pulls in place
- Controlled crease pulling
- Locking wheel adjustment

UPGRADES:

9 Finger Bear
Claw Attach.
DF-505BP/09

Add-on Wheel Puller
DF-505BP/01

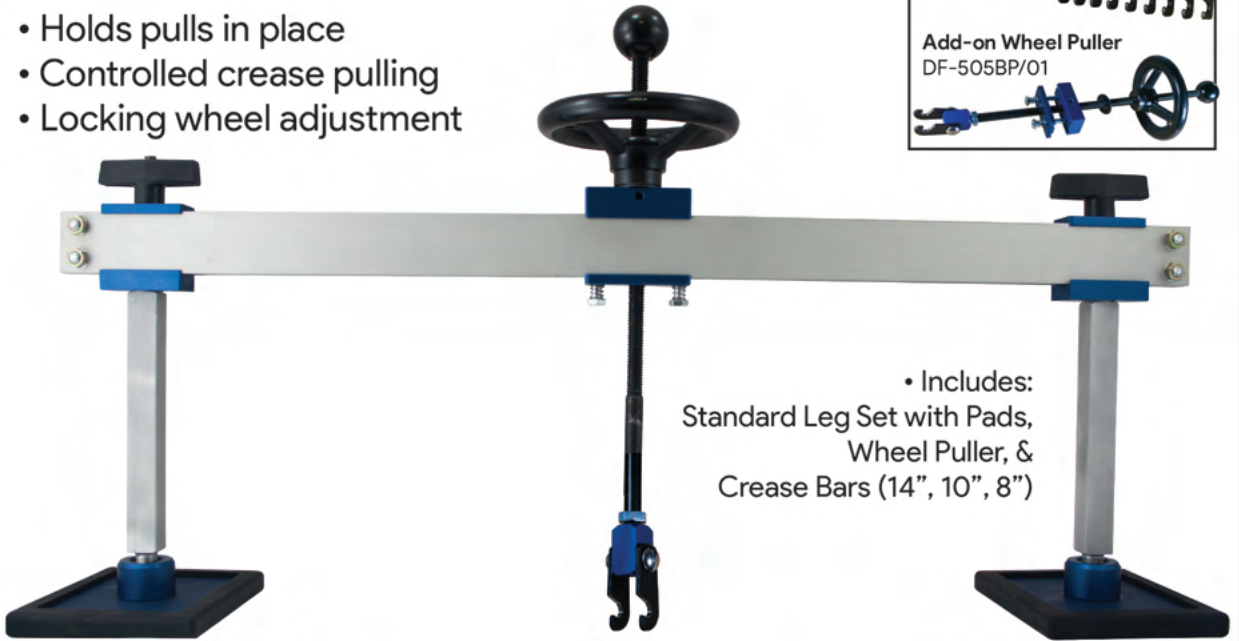

- Includes:
Standard Leg Set with Pads,
Wheel Puller, &
Crease Bars (14", 10", 8")

GLUE ACCESSORIES:

High Strength/
High Humidity
DF-HS10



Professional
Strength
DF-PG10

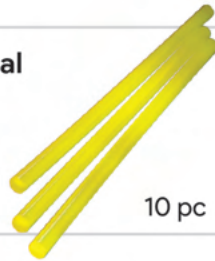

Original
Strength
DF-DM520GS

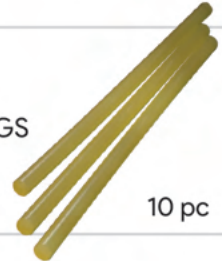

GLUE PAD ACCESSORIES: *(EYELETS SOLD SEPARATELY)



Screw Down
Eyelet (Single)

DF-GPX/EY



1.5"

DF-GPX/P1*



2"

DF-GPX/P2*



3"

DF-GPX/P3*



4"

DF-GPX/P4*



5"

DF-GPX/P5*

PULL ACCESSORIES:

Post Pull Attachment



DF-GPX/AP

Chain Pull Attachment



DF-GPX/CP

Triangular Pull Plate



DF-GPX/TP

Pull Strap (Single)



DF-GPX/PS



GLUE PULLER XTREME DF-GPX

- Fix major dents with no heat input
- Critical for repairing heat sensitive materials
- Save time by avoiding welding/arc procedures
- Repair without damaging undercoating

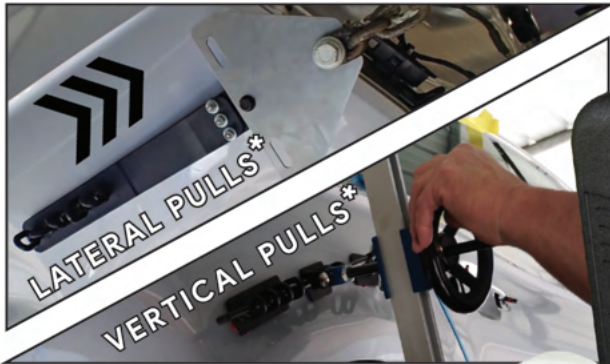

- Kit Includes:**
- Ringed Pulling Pads (1-5 Ringed)
 - Knockdown Tool (DF-KDTE)
 - Pulling Rig with 3 bars
 - Plastic Scraper Stick (DF-WK30)
 - Release Agent
 - Glue Gun
 - Glue Samples
 - Blow Molded Case

*NOTE: PULLING DEVICES SOURCED SEPARATELY



33PC PDR ROD KIT DF-PDRKIT33

- Professionally crafted PDR rods and hangers
- Essential gathering of expertly designed pieces
- Access the back of the panel with ease
- Duffel bag case

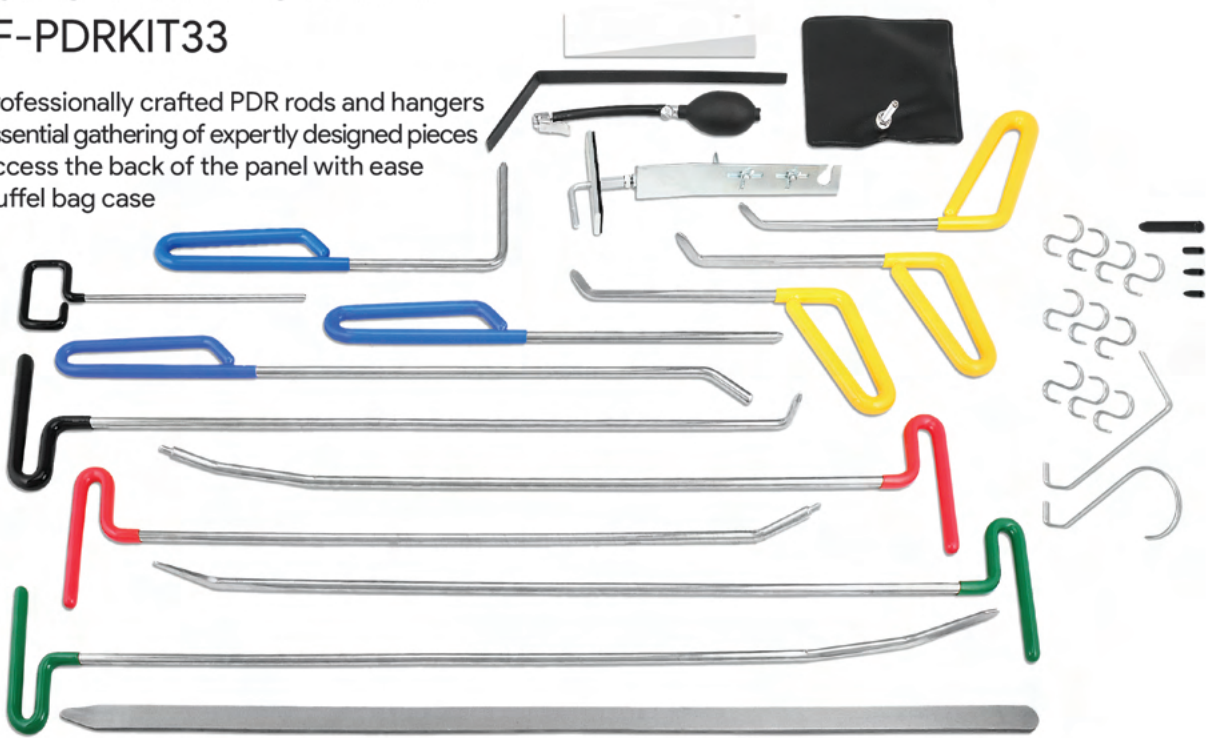

ULTRA DING MASSAGER DF-DM555UDX

- Dings, dents, & hail damage
- Easy to use & learn
- Special nibs for crease repair
- Works on steel or aluminum
- Use on OEM paint only

Kit Includes:

- x24 Assorted Pulling Nibs (DF-DM15)
- x12 Glue Sticks (DF-DM520GS)
- 120v Glue Gun (DF-DM530GG)
- Knockdown Tool (DF-KDTE)
- Squeeze Puller (DF-DM540SP)
- Slide Hammer (DF-DM530SH)
- T-Puller (DF-TPG)
- Shaping Tools
- Plastic Scraper Stick (DF-WK30)
- Release Agent (DF-DM520RA)
- Blow Molded Case



8PC PDR ROD KIT DF-PDRKIT8

- Great introductory set of PDR tools
- All basic tools needed to start working
- Case zips up for easy transportation

**CASE FOR
MOBILE TECHS**

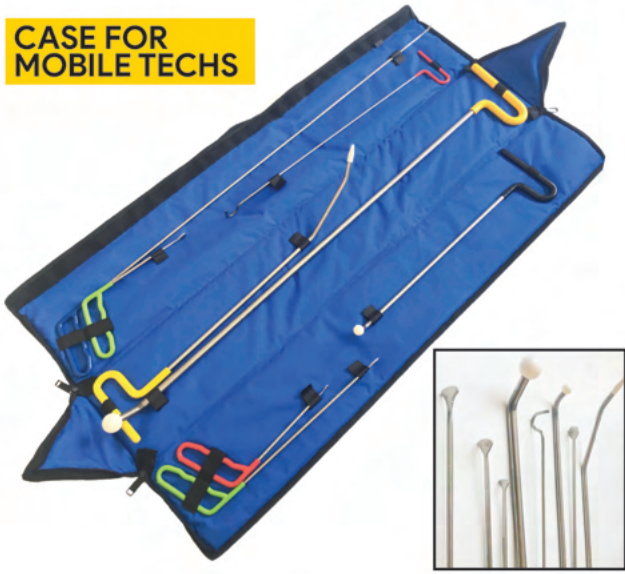

KNOCKDOWN TOOL KIT DF-KDTE

- Four interchangeable heads
- Extend body from 100mm to 130mm
- Ideal PDR tool for high spots and small dents
- Knurled finish for precision handling & grip



DEAD BLOW HAMMER KIT DF-DB79K

- Gently knock down high spots
- Remove glue residue with the wedge end
- Include case to store hammer & tips
- Option: Hammer Only # DF-DB69

**GREAT FOR
PDR WORK**

**SIX TIPS
INTERCHANGABLE**



DING ENHANCER SHIELD DF-DM55DE

From body shop estimating to dealer service check-ins, document the damage by highlighting the dings.

- Sturdy grab handle
- Large 31" diameter
- Collapsible with storage bag

**DOCUMENT THE
DAMAGE**

**WRITE PERFECT
ESTIMATES**





DIGITAL TRAM GAUGE DF-3DX

- Easy read LCD digital display
- Measures in metric or American standard
- Measures from 1'4" to 11'11"

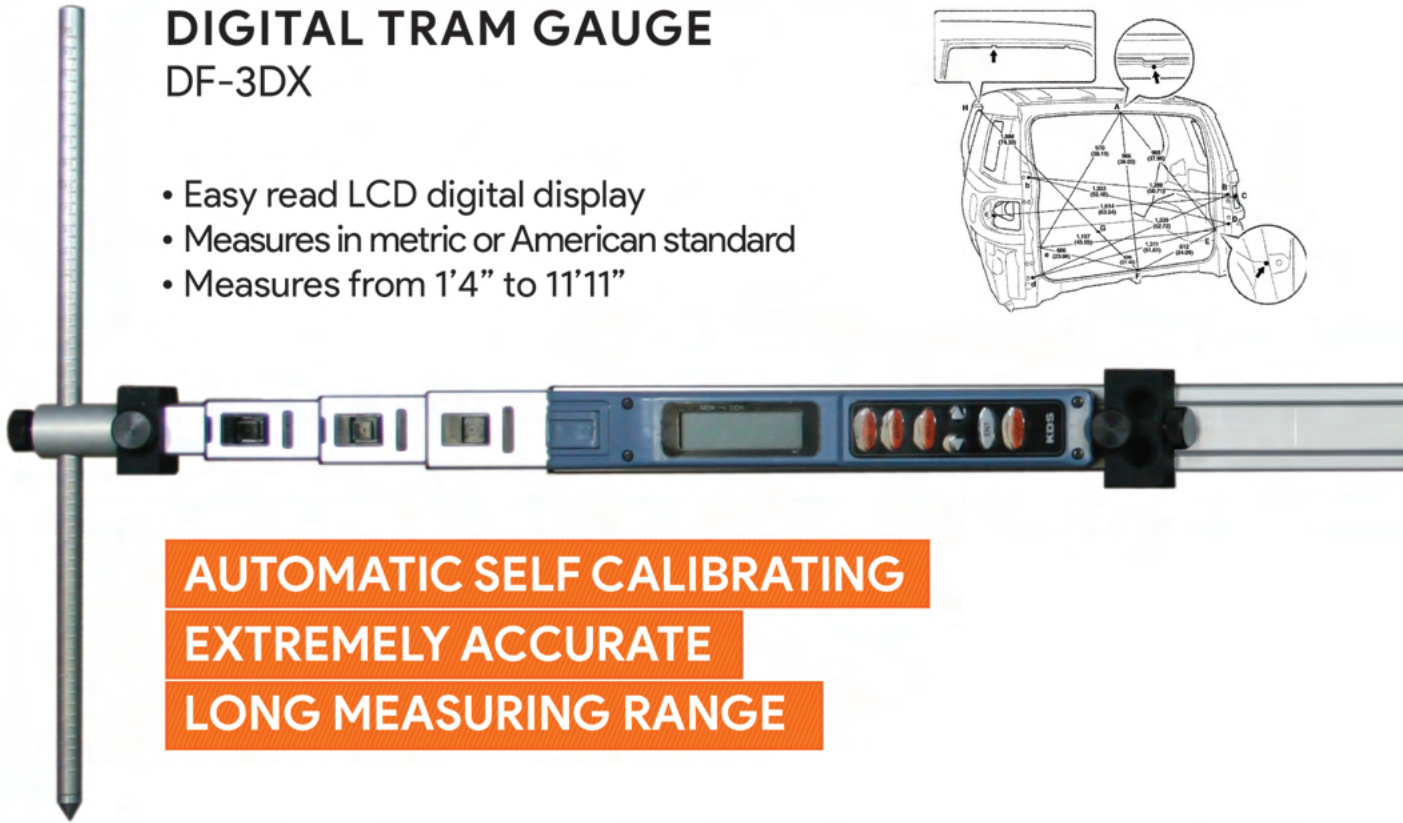
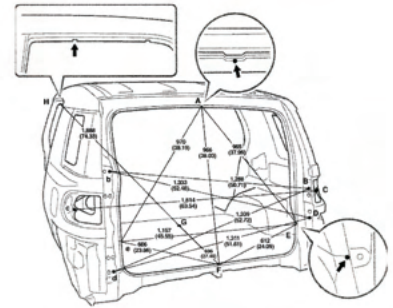

AUTOMATIC SELF CALIBRATING
EXTREMELY ACCURATE
LONG MEASURING RANGE

SWISS TRAM DF-3

HIGHLY ACCURATE

10'6"
MAX



- Accurate to +/- 1.0mm
- Easy to read tape measure
- Measures 3' to 10'6"

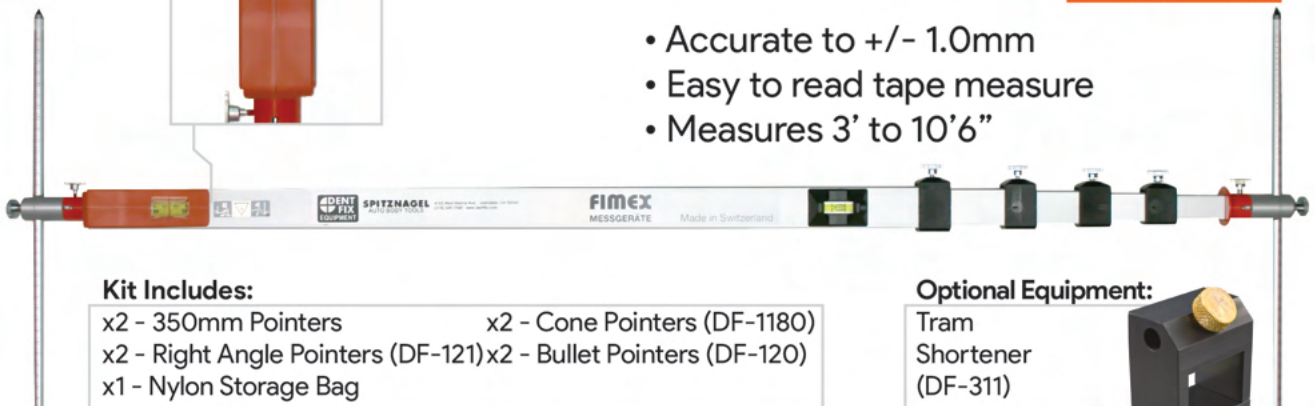

Kit Includes:

- x2 - 350mm Pointers
- x2 - Cone Pointers (DF-1180)
- x2 - Right Angle Pointers (DF-121)
- x2 - Bullet Pointers (DF-120)
- x1 - Nylon Storage Bag

Optional Equipment:

- Tram Shortener (DF-311)





Digital Display: Easy to read LCD screen vividly shows measurement readouts. Measures in both metric and American standard

- Kit Includes:
- x3 - 350mm Pointers (DF-301)
 - x2 - 110mm Pointers (DF-302)
 - x2 - Cone Pointers
 - x2 - Bullet Pointers
 - x2 - Pointer Holders
 - x4 - AA Batteries
 - x1 - Blow Molded Case
- Optional Equipment:
- 700mm Pointers (DF-309)



11' 11" MAX

MINI TRAM DF-3S

MINI & HIGHLY ACCURATE

3'3" MAX

- Accurate to +/- 1.0mm
- Easy to read tape measure
- Measures 16.69" to 3'3"

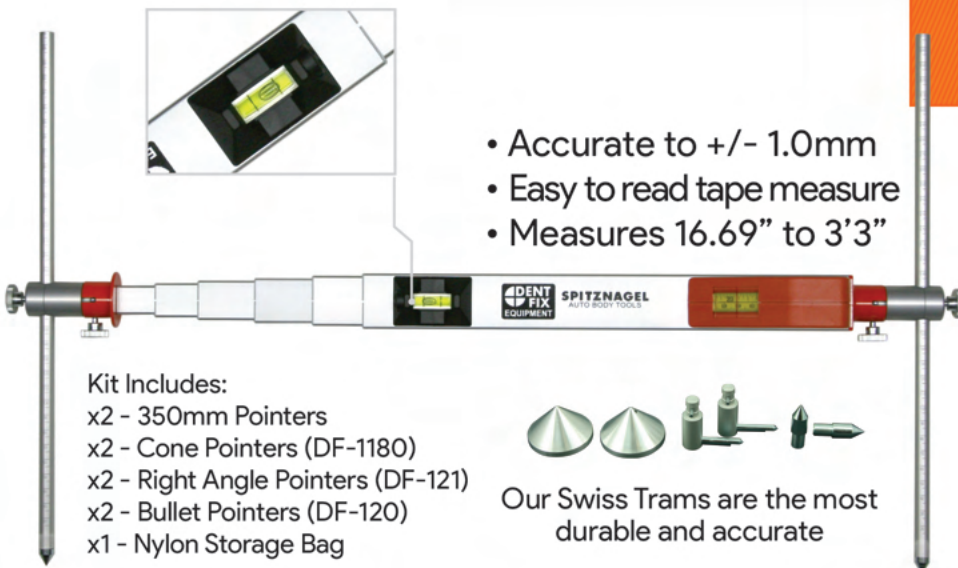

- Kit Includes:
- x2 - 350mm Pointers
 - x2 - Cone Pointers (DF-1180)
 - x2 - Right Angle Pointers (DF-121)
 - x2 - Bullet Pointers (DF-120)
 - x1 - Nylon Storage Bag

Our Swiss Trams are the most durable and accurate

5 METER TRAM DF-3TC5A

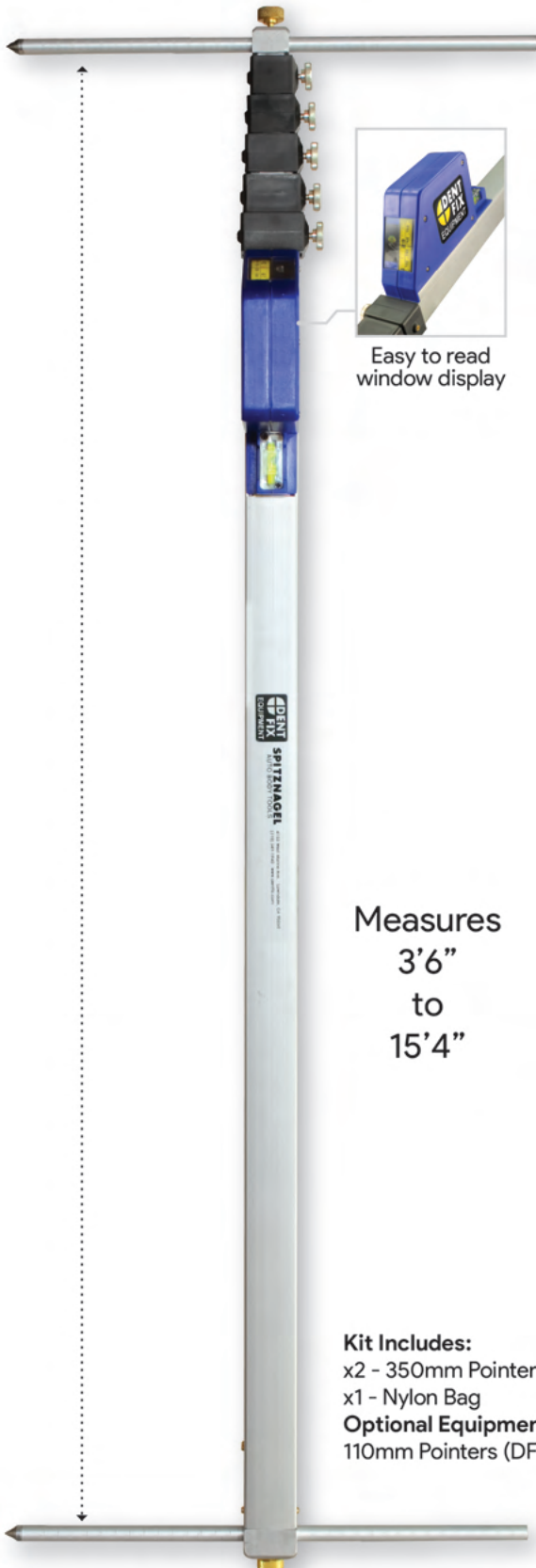

Easy to read window display

Measures
3'6"
to
15'4"

Kit Includes:
x2 - 350mm Pointers
x1 - Nylon Bag
Optional Equipment:
110mm Pointers (DF-302)

SELF CENTERING TIPS DF-3TCAS

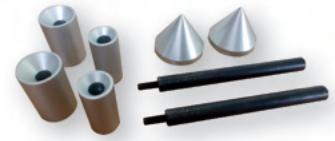

MORE ACCURATE MEASUREMENTS

Kit Includes:
x2 Cone Adapters
x2 Small Bolt Adapters
x2 Large Bolt Adapters
x2 Extension Bars
Foam Drawer Insert

**UPGRADE for the
5 Meter & 3 Meter Trams**

3 METER TRAM DF-3TC3A

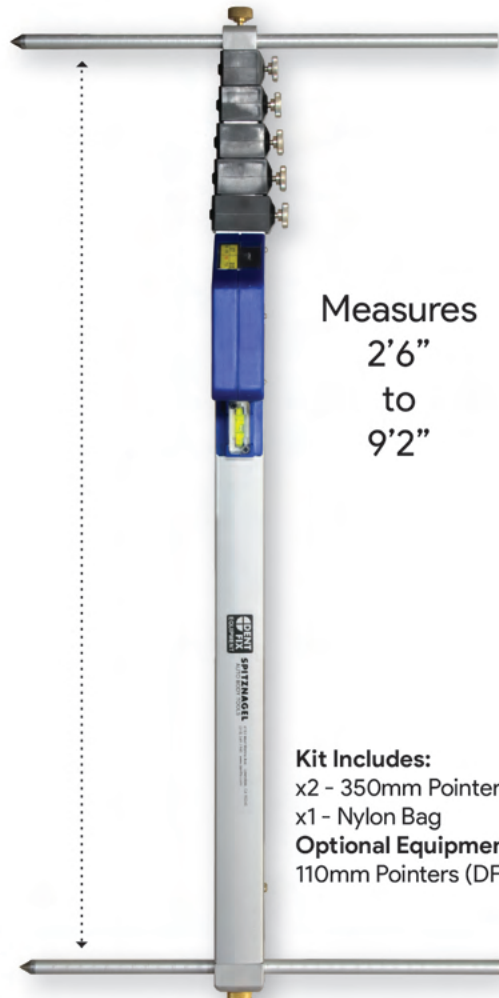

Measures
2'6"
to
9'2"

Kit Includes:
x2 - 350mm Pointers
x1 - Nylon Bag
Optional Equipment:
110mm Pointers (DF-302)



PERFECT GAP GAUGE

DF-PG213

- Eliminates the guess work
- Sets the gap width to factory specs
- 1 to 10mm (1mm per spacer, 10 total)

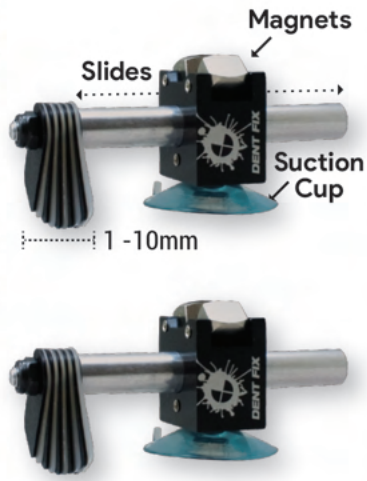

SET OF 2 INCLUDED

SET EXACT FENDER GAP

BODY LINE TOOL XL

DF-BL10XL

- Perfectly re-creates body lines
- Made in the USA
- Range of 0.5" to 8.5"



THE BEST SELLING BODY LINE TOOL JUST GOT BIGGER

BODY LINE TOOL

DF-BL10A

- Re-create fender curves perfectly
- Made in the USA
- Range of 0.5" to 4.75"

TRACE PERFECT BODY ARCHES



Trace block is adjustable up and down



Trace block is adjustable up and down



PENCIL SHARPENER

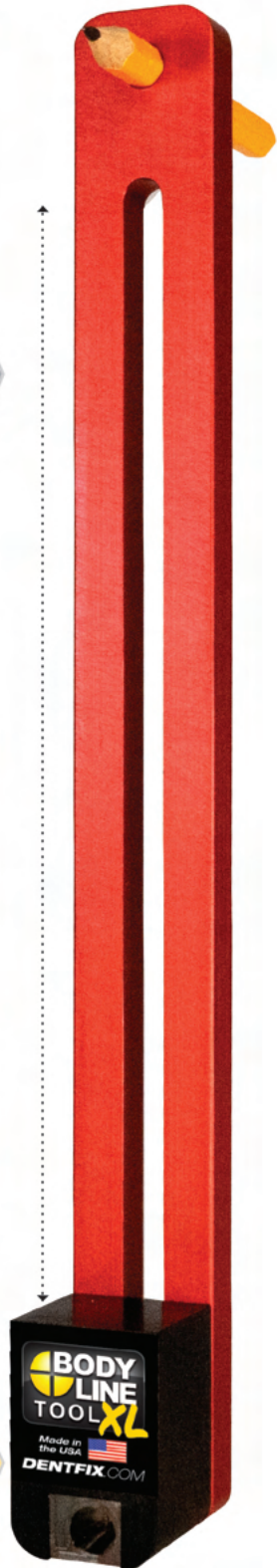

SUCTION GUN DF-SG70

- Safely remove head/tail lights and glass-like surfaces
- Hold windows in place while working on window regulators
- Quick release button



**REMOVE SNUG PARTS,
LESS BREAKAGE**



Press the rubber cup flat against a clean, dry glass surface. Squeeze trigger to engage.



When engaged the gray locking button will click. Press gray locking button to disengage suction

MAGNETIC LED LIGHT DF-LED935

- Super bright COB (Chip on board) LED
- Hangable magnetic swivel base
- Adjustable dimmer switch



USB
RECHARGE



935 LUX

Max Hours: 12
Charge Time: 4
Hours
Battery: LI-ION

**SLIM PROFILE LAMP FITS
INTO TIGHT SPACES**





TORNADOR BLACK DF-Z020

- DOUBLE the power of the Tornador Classic
- Lower wear pulse action and less maintenance
- Operates at a turbo charged 3,600 RPM

PULSE CLEANING



ADD LIQUID CLEANERS

Air Pressure: 5.2-6.4 CFM @ 90 PSI
 Air Inlet: 1/4"
 Free Speed RPM: 3,600
 Weight: 1.34 lbs



High Quality Construction

TORNADOR PULSE DETAIL TOOL DF-Z014

- Pulsation of air will beat the dirt out
- Durable alloy construction
- Patented tube provides Tornador action

PULSE CLEANING



Air Pressure: 5.2-6.4 CFM @ 70 PSI
 Air Inlet: 1/4"
 Free Speed: 3,600
 Weight: 0.93 lbs

TORNADOR CLASSIC DF-Z010

- Pulse cleaning gun with reservoir
- Excellent for soft surface cleaning
- Efficiently delivers additives in a fine mist



ADD LIQUID CLEANERS



Air Pressure: 5.2-6.4 CFM @ 90 PSI
 Air Inlet: 1/4"
 Jar Capacity: 32oz
 Weight: 1.34 lbs





| Description | Size/Style | Quantity | Part Number |
|---------------------|------------|----------|--------------|
| ALUSPOT ● | | | |
| Alu-Magnesium Studs | M4x25 | 500 pc | DF-900PM/500 |
| Alu-Silicon Studs | M4x25 | 500 pc | DF-900PS/500 |
| Pull Finger | Spitznagel | 1 pc | DF-900PF |
| Fiber Discs | - | 6 pc | DF-710BW |
| Replacement Blade | - | 1 pc | DF-900BFH |

| RIVMAX & 10 Ton Riveter* ● | | | *DF-SPR/BRAD70 needed for Blind Rivets |
|---------------------------------------|-----------------|---------|--|
| Universal Rivet Assortment Kit | SPR/Blind | Variety | DF-URAK |
| FORD Die Kit | FORD | Kit | DF-SPR/FORD70 |
| Extractor Die Set E1/E2 | MALE/FEMALE | 1 each | DF-SPR/ED |
| Extractor Die E1 | MALE ONLY | 5 pc | DF-SPR/E1X5 |
| SPR Die Set A1/A2 | 3.3mm | 1 each | DF-SPR/AD |
| SPR Die Set B1/B2 | 5.3mm | 1 each | DF-SPR/BD |
| Hole Punch Die Set T1/T2 | Punch | 1 each | DF-SPR/TD |
| Flow Form Die Set F1/F2 | Flow Form | 1 each | DF-SPR/FD |
| Flattening Die Set D17/D17 | Flat | 1 each | DF-SPR/D17 |
| SPR Rivets 5.3mm Diameter | 4.0mm Height | 100 pc | DF-SPR54 |
| SPR Rivets 5.3mm Diameter | 5.0mm Height | 100 pc | DF-SPR55 |
| SPR Rivets 5.3mm Diameter | 6.0mm Height | 100 pc | DF-SPR56 |
| SPR Rivets 5.3mm Diameter | 6.5mm Height | 100 pc | DF-SPR565 |
| SPR Rivets 5.3mm Diameter | 7.0mm Height | 100 pc | DF-SPR57 |
| SPR Rivets 5.3mm Diameter | 7.5mm Height | 100 pc | DF-SPR575 |
| SPR Rivets 5.3mm Diameter | 8.0mm Height | 100 pc | DF-SPR58 |
| SPR Rivets 5.3mm Diameter | 9.0mm Height | 100 pc | DF-SPR59 |
| SPR Rivets 5.3mm Diameter | 10.0mm Height | 100 pc | DF-SPR510 |
| SPR Rivets 5.3mm Diameter | 12.0mm Height | 100 pc | DF-SPR512 |
| SPR Rivets 3.3mm Diameter | 3.5mm Height | 200 pc | DF-SPR33 |
| SPR Rivets 3.3mm Diameter | 4.0mm Height | 200 pc | DF-SPR34 |
| SPR Rivets 3.3mm Diameter | 5.0mm Height | 200 pc | DF-SPR35 |
| SPR Rivets 3.3mm Diameter | 6.0mm Height | 200 pc | DF-SPR36 |
| Blind Rivets 1/4"x1/2" | .060-.138" Grip | 10 pc | DF-BRS10 |
| Blind Rivets 1/4"x1/2" | .110-.189" Grip | 10 pc | DF-BRS11 |
| Blind Rivets 1/4"x1/2" | .189-.238" Grip | 10 pc | DF-BRS12 |
| Blind Rivets 1/4"x1/2" | .238-.346" Grip | 10 pc | DF-BRS13 |

| MAXI* ● | | | *For MAXI DXE replacement glue pulling consumables see GPR + PDR section |
|--------------------------|---------|------------|--|
| Weld Pull Keys | Flat | 100 pc | DF-503KF |
| Weld Pull Keys | Twisted | 100 pc | DF-503KT |
| Weld Rods - Slide Hammer | 10" | 3 pc | DF-503L |
| Weld Rods - Pulling | 5.5" | 3 pc | DF-503 |
| Wiggle Wire - Thick | 1 lb. | Apx. 30 pc | DF-507TK |
| Wiggle Wire - Thin | 1 lb. | Apx. 60 pc | DF-507 |



| Description | Size/Style | Quantity | Part Number |
|-------------------------|----------------|----------|-------------|
| PLASTIC REPAIR ● | | | |
| StapleClip Hot Staples | Z-Clip | 50 pc | DF-800ZC/50 |
| StapleClip Hot Staples | N-Clip | 50 pc | DF-800NC/50 |
| StapleClip Hot Staples | S-Clip | 50 pc | DF-800SC/50 |
| StapleClip Hot Staples | M-Clip | 50 pc | DF-800MC/50 |
| StapleClip Hot Staples | W-Clip | 50 pc | DF-800WC/50 |
| StapleClip Hot Staples | V-Clip | 50 pc | DF-800VC/50 |
| StapleClip Hot Staples | U-Clip | 50 pc | DF-800UC/50 |
| ABS | 3mm Triangle | 25 pc | DF-ABBK03T |
| ABS | 3mm Round | 25 pc | DF-ABBK03 |
| ABS | 9mm Flat | 25 pc | DF-ABBK09 |
| ABS | 15mm Flat | 25 pc | DF-ABBK15 |
| PolyCARBONATE | 3mm Triangle | 25 pc | DF-PCNT03T |
| PolyCARBONATE | 3mm Round | 25 pc | DF-PCNT03 |
| PolyCARBONATE | 6mm Flat | 25 pc | DF-PCNT06 |
| PolyCARBONATE | 9mm Flat | 25 pc | DF-PCNT09 |
| PolyETHYLENE | 3mm Round | 25 pc | DF-PEBK03 |
| PolyETHYLENE | 9mm Flat | 25 pc | DF-PEBK09 |
| PolyETHYLENE | 15mm Flat | 25 pc | DF-PEBK15 |
| PolyPROPYLENE | 3mm Triangle | 25 pc | DF-PPBK03T |
| PolyPROPYLENE | 3mm Round | 25 pc | DF-PPBK03 |
| PolyPROPYLENE | 6mm Flat | 25 pc | DF-PPBK06 |
| PolyPROPYLENE | 9mm Flat | 25 pc | DF-PPBK09 |
| PolyPROPYLENE | 15mm Flat | 25 pc | DF-PPBK15 |
| PolyURETHANE | 3mm Round | 25 pc | DF-PUNT03 |

GPR + PDR ●

| | | | |
|------------------------------|-------------------|-------|------------|
| Red Glue | High Humidity | 10 pc | DF-HS10 |
| Yellow Glue | Profess. Strength | 10 pc | DF-PG10 |
| Amber Glue | Original | 10 pc | DF-DM520DS |
| GPX Screw Down Eyelet | - | 1 pc | DF-GPX/EY |
| GPX Glue Pad Single* | 1.5" | 1 pc | DF-GPX/E1 |
| GPX Glue Pad Double* | 2" | 1 pc | DF-GPX/E2 |
| GPX Glue Pad Triple* | 3" | 1 pc | DF-GPX/E3 |
| GPX Glue Pad Quadruple* | 4" | 1 pc | DF-GPX/E4 |
| GPX Glue Pad Quintuple* | 5" | 1 pc | DF-GPX/E5 |
| Ultra Ding Massager PDR Nibs | Variety Pack | 24 pc | DF-DM24VP |

*Eyelets NOT included

CAN'T FIND WHAT YOU ARE LOOKING FOR?
 MORE AVAILABLE AT
www.DENTFIX.COM or CALL (310) 349-1940





FOLLOW US & POST !
@dentfixequipment



www.DENTFIX.com