

SATAjet® X 5500



German Engineering

Spray Guns | Cup Systems | Breathing Protection | Air Filtration | Accessories



Revolutionary. Efficient. Silent.
Consistent.

The revolutionary nozzle system

State-of-the-art paint systems and the latest application recommendations open up new possibilities, but also pose new challenges for professional painters. The SATAjet X 5500 featuring the new X-nozzle system now defines a new application standard for the future.

The concept of this nozzle system is easy and straightforward to understand: Both proven application technologies – HVLP and RP – remain available, but now each of them offer the additional choice between "I" and "O"-nozzle sets. In line with the increasing nozzle sizes within each of the respective technology (HVLP / RP), the material flow rate increases too with constant increments, which means that the spray fan size and width remain unchanged across the entire nozzle spectrum. In essence, end-users can now rely on a transparent and consistent system which offers them clear and well-structured application options.

The "I"-nozzles produce a parallel spray fan pattern with a minimal dry zone and a drier center which is ideal for painters preferring a **reduced application speed** and maximum application control during the painting process. The **film build per coat** in comparison to an "O"-nozzle of the same size is **slightly reduced**.

- Parallel spray fan with minimal dry zone
- Improved control during the coating process
- Reduced film build per coat compared to the nozzle set currently in use or the "O"-nozzle

"O"-nozzles do have an oval-shaped spray fan pattern with a larger dry zone and a wet core to accommodate **increased application speed** at the expense of slightly less application control during the painting process. The **film build per coat** in comparison to an "I"-nozzle is **slightly higher**.

- Oval-shaped spray fan with larger dry zone
- Wet core for increased application speed
- Film build per coat slightly higher compared to the "I"-nozzle



SATAjet® X 5500 RP®

PRODUCT BENEFITS

- Revolutionary: The X-nozzles are taking atomization to a whole new level
- Noticeably quieter: Whispering nozzle™ due to optimized air flow geometry, reduced noise level in the relevant sound frequency ranges
- Individual: Matches each application requirement, such as specific characteristics of the paint system, climatic conditions and application method (application speed/application control)
- Precise: Optimized material distribution for enhanced spraying uniformity and atomization with both spray fan shapes
- Low maintenance: No air distribution insert required, thus also ensuring a much easier and faster cleaning process
- Consistent: Constant fan size across the entire nozzle spectrum (within the range of each respective atomization technology) with linear increases of the material flow rate
- Efficient: The optimized atomization concept enables to realize considerable material savings using the same application method as before

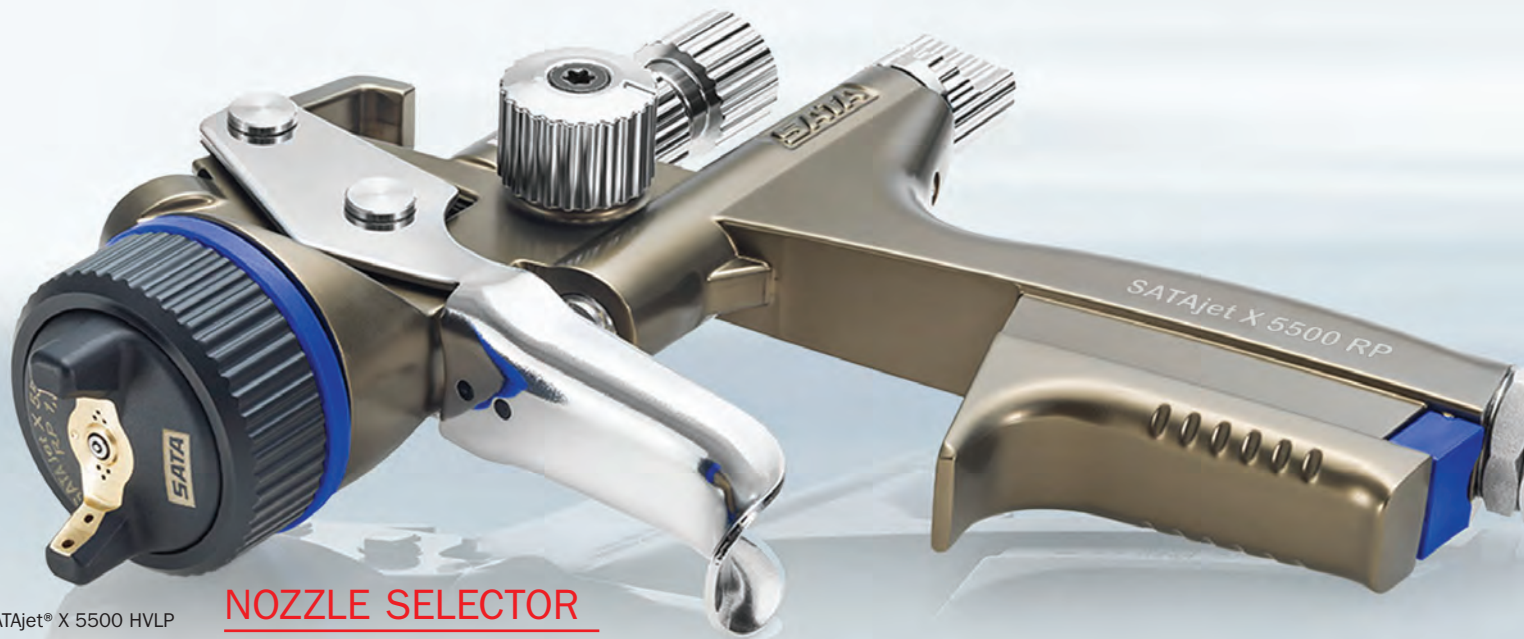

SATAjet® X 5500 HVLP

NOZZLE SELECTOR

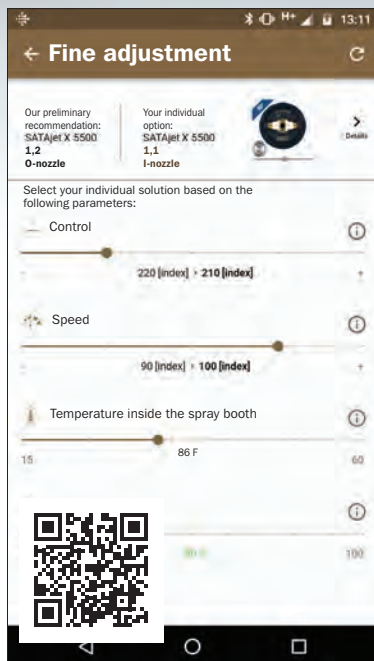

www.sata.com/nozzlefinder

What are the advantages of the X-nozzle system?

Depending on the properties of the paint system, the climatic conditions and the application technique, each painter can now select a spray gun with the suitable nozzle set for their individual requirements. Due to the consistency of the system, it is easy to choose the correct nozzle option enabling painters to achieve optimum finishes.



Perfect ergonomic design – the SATAjet X 5500 with optimized shape of the gun handle fits perfectly in the palm of the hand



A uniform and adjustable spray fan according to the specific requirements – the SATAjet X 5500 for perfect finishes

What else is new?

Due to the optimized air distribution inside the spray gun body in combination with the new design of fluid tip and air cap, the air distribution ring is no longer required. In addition, we have managed to reduce the noise level of this whispering nozzle during application, giving painters the feeling of a much softer and more comfortable coating process. And the best of all: The X-nozzles considerably reduce paint waste!

SPRAY FAN SHAPES

Examples of current fan shapes

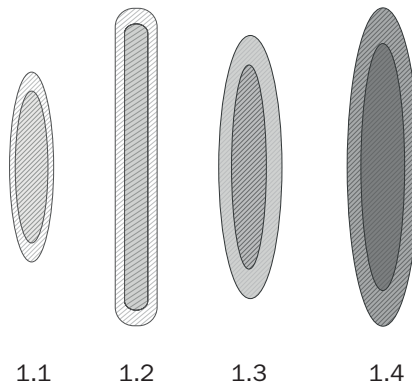

New with SATAjet X 5500

Fan shape I-nozzle HVLP/RP

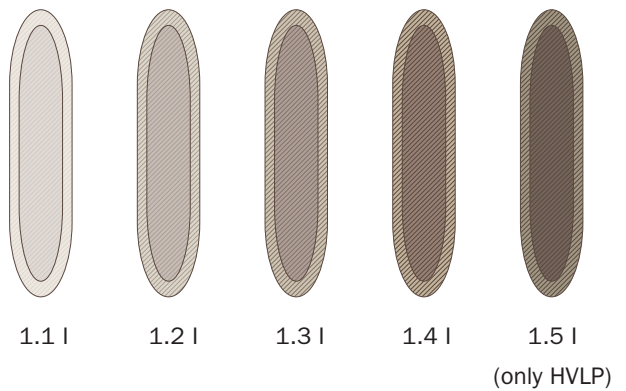

Fan shape O-nozzle HVLP/RP

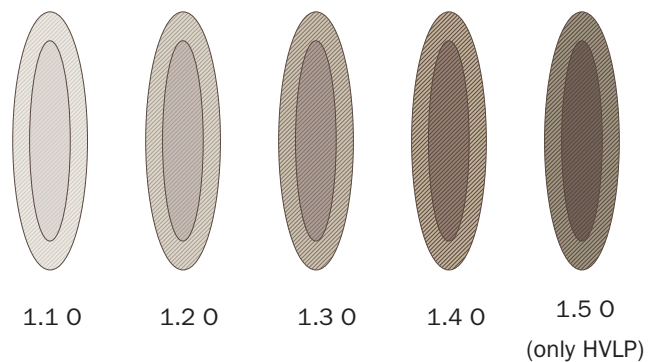

To achieve an optimum spray fan without any compromise, more factors than just ambient temperature and humidity have to be taken into account. The selected coating material with appropriate additives, the dimensions of the object to be painted, the recommended film thickness, the individual painting habits such as application speed or application control are also playing an important role when choosing the correct nozzle size.

Please strictly observe the recommendations of the paint manufacturer.

The SATAjet X 5500, perfection down to the smallest detail



Robust air cap made of chrome-plated brass with QC™ air cap thread for quick change with one turn only.
 Air cap ring:
 green = HVL/ technology
 blue = RP technology



QCC® – Quick Cup Connector. Bayonet cup connection. Ensures quick and clean cup change as well as easy cleaning.

Fluid tip and paint needle made of corrosion-resistant stainless steel

Material passage (red)

Air passage (blue)

Fluid tip seal ensuring minimal cleaning efforts and safe color change

Low maintenance, self-tensioning air piston and paint needle packings

Trigger with paint needle protection for an extended lifetime of the paint needle packing

Option: Digital pressure display for exact pressure adjustment, perfect color match and reproducibility



CCS™ – Color Code System. For the convenient identification of your spray gun.

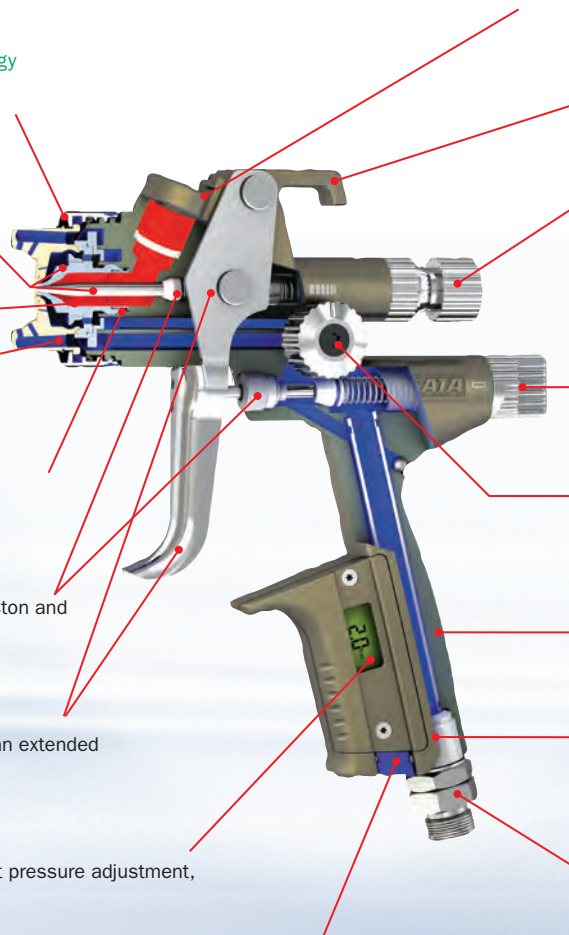

Gun suspension hook for convenient storage

Control elements can be perfectly adjusted even wearing gloves: material flow control with good grip

Air micrometer for the adjustment of the atomization air. Highest precision with digital pressure gauge (**optional**)

Spray fan control allowing fine adjustment with a half turn only

Ergonomically shaped gun handle

Easy to clean, corrosion-resistant anodized surface

Air connection 1/4" male thread with swivel joint



Warranty: Talking quality is not enough – we guarantee it: for three years!

Two ways to achieve a perfect result: **HVL/** and **RP®**

The "Super Saver" SATAjet X 5500 HVL/ achieves particularly high transfer rates, due to its low pressure technology.

The "Super Speed" SATAjet X 5500 RP with its optimized high pressure technology for maximum application speed and minimum over spray.

Both versions are extremely versatile in application, meeting highest expectations concerning excellent finishes, while far exceeding 65% transfer efficiency rates in accordance with VOC legislation.

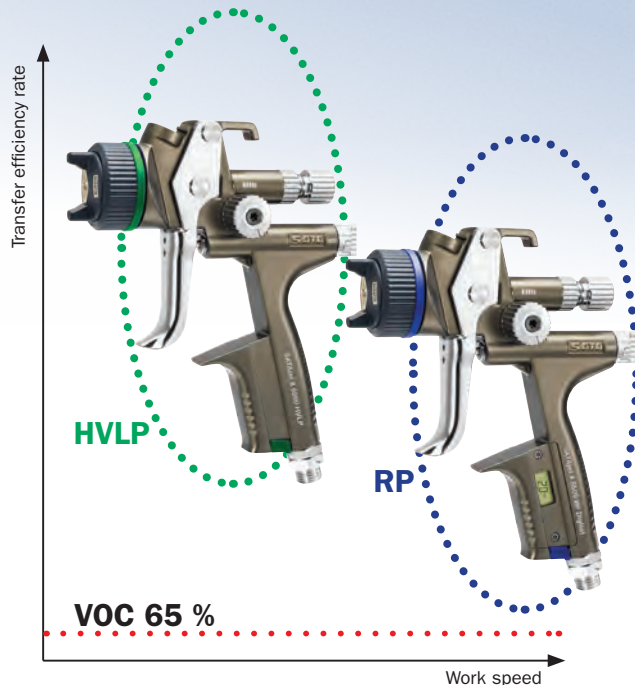

Perfect for all fields of application – SATAjet X 5500

The SATAjet X 5500, achieving brilliant finishes: Whether it be in car refinish, commercial transportation, coating furniture, marine yachts or high quality industrial components – regardless of the paint system being used.

Whether for basecoat, clear coat or single-stage material, please ask your SATA dealer or consult our website for the correct nozzle size: www.sata.com/SATAjetX5500

Nozzle size*	HVLV	I-nozzles					O-nozzles				
		1,1 l	1,2 l	1,3 l	1,4 l	1,5 l	1,1 0	1,2 0	1,3 0	1,4 0	1,5 0
		RP	1,1 l	1,2 l	1,3 l	1,4 l	-	1,1 0	1,2 0	1,3 0	1,4 0
Cpl. with each 1x RPS multipurpose cup 0.6 l / 0.9 l, with swivel joint		1061895	1061902	1061887	1061910	1061928	1061936	1061944	1061952	1061960	1061978
		1061548	1061556	1061564	1061572	-	1061580	1061598	1061605	1061613	-
DIGITAL cpl. with each 1x RPS multipurpose cup 0.6 l / 0.9 l, with swivel joint		1062009	1061986	1062017	1062041	1062059	1062083	1062091	1062132	1062140	1062174
		1061639	1061655	1061704	1061738	-	1061770	1061796	1061811	1061837	-
Nozzle set		1063619	1063627	1063635	1063651	1063669	1063677	1063685	1063643	1063693	1063700
		1063536	1063544	1063552	1063560	-	1063578	1063586	1063594	1063601	-

*Nozzle range for market launch

RP version pending approval.

Accessories:

SATA® adam 2™, SATA® adam 2™ black

To upgrade non-digital spray guns to "DIGITAL" the version for retrofitting the SATAjet 5000 or SATAjet X 5500 Standard without integrated digital pressure gauge. Ensures correct setting and display of the gun inlet pressure for highest reproducibility.
Part No. 211557 chrome
Part No. 1031715 black



SATA® RPS®

Replaces reusable plastic cups and fits on the SATA spray guns without adapter. Reduces cleaning effort and helps save solvents. Available sizes: 0.3 l, 0.6 l and 0.9 l.
Part No. upon request



SATA® cert™

Prevent rework before it occurs – with the regular checking of the spray pattern.
Part No. 161596



SATA® care set™

The practical tool bag containing useful utensils for gun cleaning and maintenance. Items marked with a red surround are not included in the scope of delivery.
Part No. 162628



Accessories like air hoses, respirators, air filter regulators etc. are available from your SATA dealer.

Your SATA dealer



DanAm®

The exclusive independent distributor of SATA products in the US and Puerto Rico

Phone: 800-533-8016

www.satausa.com

E-mail: satajet@satausa.com

Errors and technical alterations reserved - SATA, SATAjet and/or other SATA products referenced herein are either registered trademarks or trademarks of SATA GmbH & Co. KG in the U.S. and/or other countries.

52 SATAjet X 5500
Printed in U.S.A.
180911